



Dual 1 Form A
Solid State Relay

DESCRIPTION

The AD4C250 is a bi-directional, double-pole, single-throw, normally open multipurpose solid-state relay. It is designed to replace electromechanical relays and reed relays in special applications that call for very fast switching times. The relay consists of two integrated circuits, each driving a pair of rugged source-to-source enhancement type DMOS transistors. Each integrated circuit is optically coupled to a light emitting diode. The output MOS transistors are specially designed to exhibit extremely low output capacitance and leakage current characteristics, making this device ideal for switching high frequency signals.

FEATURES

- High input-to-output isolation
- Low input control power consumption
- 40mA maximum continuous load current
- 300 ohms maximum on-resistance
- Long life/high reliability
- Fast switching speeds
- Low output capacitance

APPLICATIONS

- Telecom switching
- Tip/Ring control
- PCMCIA modules
- Multiplexers
- Meter reading systems
- Data acquisition
- Medical equipment
- Battery monitoring
- Home/Safety security systems

OPTIONS/SUFFIXES

- -S Surface Mount Option
- -TR Tape and Reel

SCHEMATIC DIAGRAM

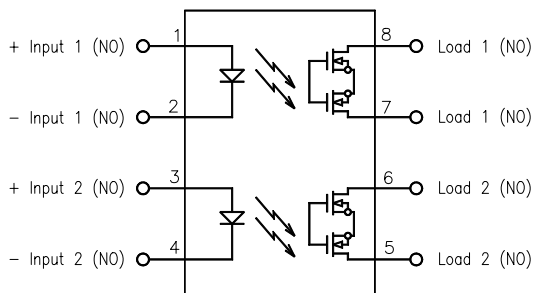

MAXIMUM RATINGS

PARAMETER	UNIT	MIN	TYP	MAX
Storage Temperature	°C	-55		125
Operating Temperature	°C	-40		85
Continuous Input Current	mA			40
Transient Input Current	mA			400
Reverse Input Control Voltage	V	6		
Output Power Dissipation	mW			500

APPROVALS

- BAPT CERTIFICATE #607836:
BS EN 60950, BS EN 41003, BS EN 60065
- CSA CERTIFICATE #LR111581-1
- UL FILE #E90096



Dual 1 Form A
Solid State Relay

ELECTRICAL CHARACTERISTICS - 25°

PARAMETER	UNIT	MIN	TYP	MAX	TEST CONDITIONS
INPUT SPECIFICATIONS					
LED Forward Voltage	V		1.2	1.5	If = 10mA
LED Reverse Voltage	V	6	12		Ir = 10uA
Turn-On Current	m A	5	2.5		Io = 40mA
Turn-Off Current	m A		0.5		
OUTPUT SPECIFICATIONS					
Blocking Voltage	V	250			Io = 10uA
Continuous Load Current	m A			40	If = 5mA
On-Resistance	Ω		225	300	Io = 40mA
Leakage Current	n A		10	100	Vo = 250V
Output Capacitance	p F		1.5	3	Vo = 25V, f = 1.0MHz
Offset Voltage	m V			0.2	If = 5mA
COUPLED SPECIFICATIONS					
Isolation Voltage	V	2500			T = 1 minute
-H Suffix	V	3750			T = 1 minute
Turn-On Time	μ s		50	500	If = 5mA, Io = 40mA
Turn-Off Time	μ s		150	500	If = 5mA, Io = 40mA
Isolation Resistance	G Ω	100			
Coupled Capacitance	p F		3		
Contact Transient Ratio	V / μ s	2000	7000		dV = 50V



Dual 1 Form A
Solid State Relay

PERFORMANCE DATA

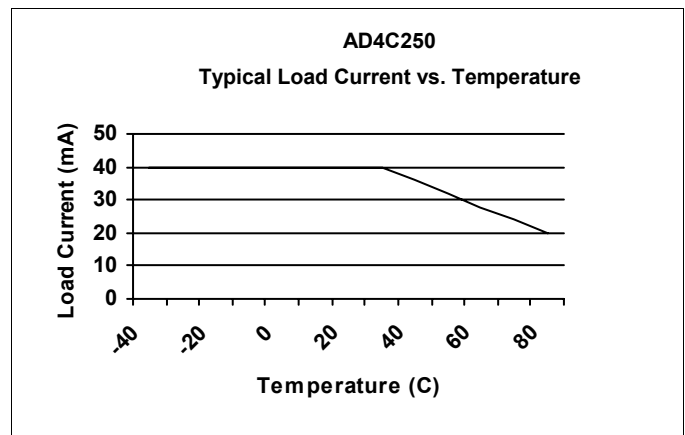
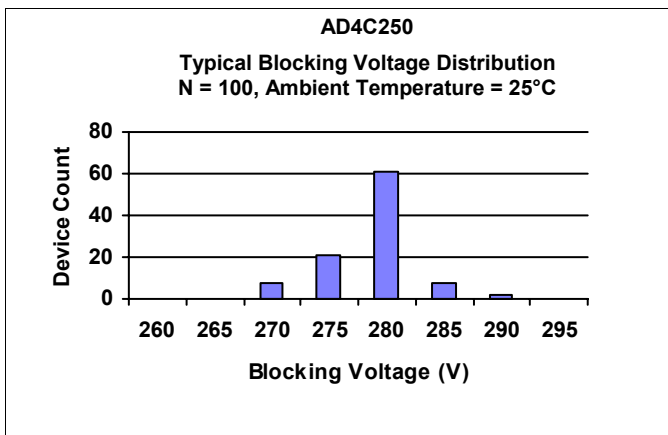
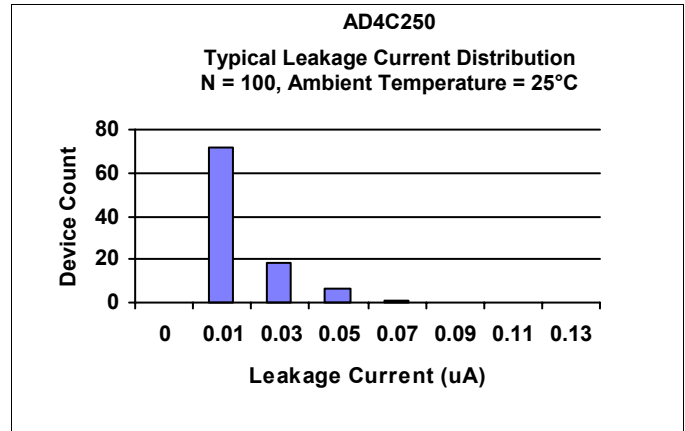
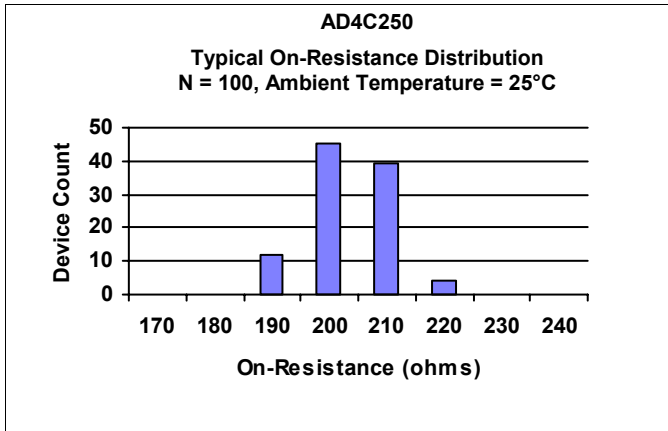
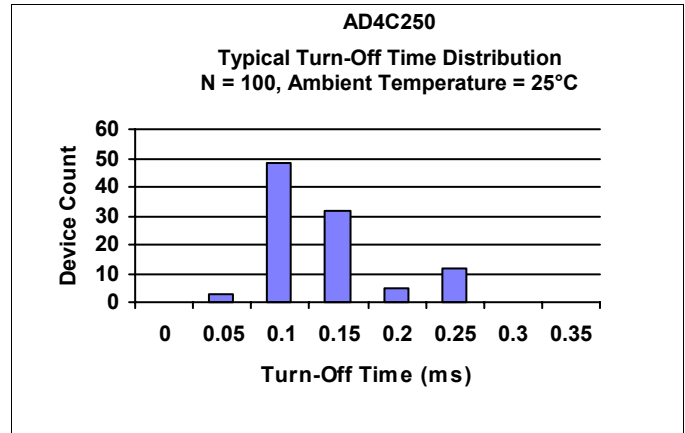
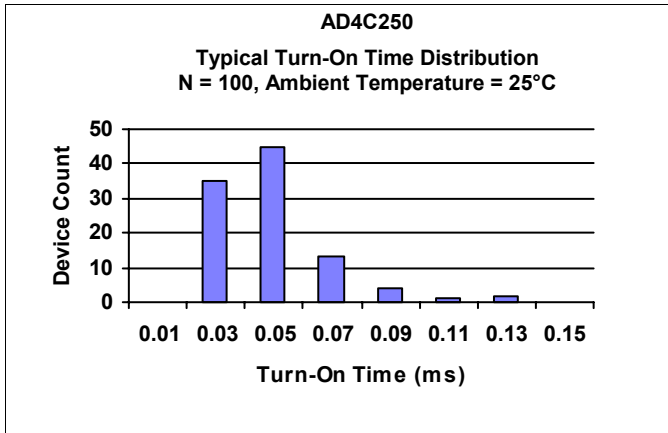



Dual 1 Form A
Solid State Relay

MECHANICAL DIMENSIONS

8 PIN DUAL IN-LINE PACKAGE

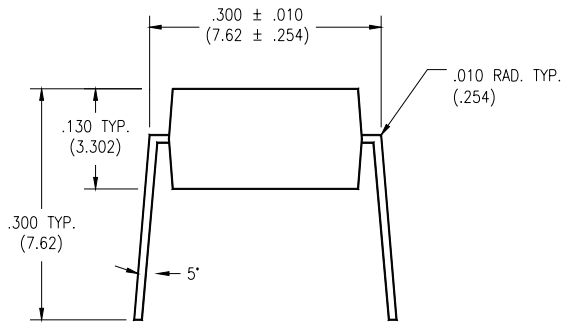

END VIEW

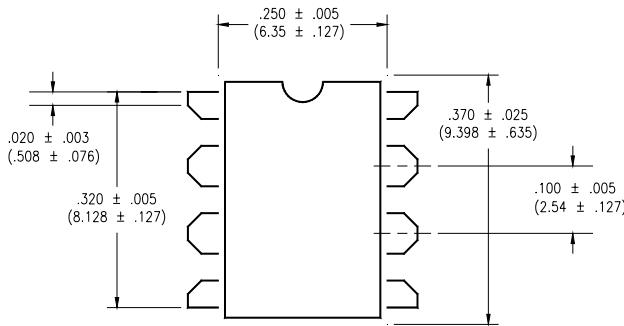

TOP VIEW

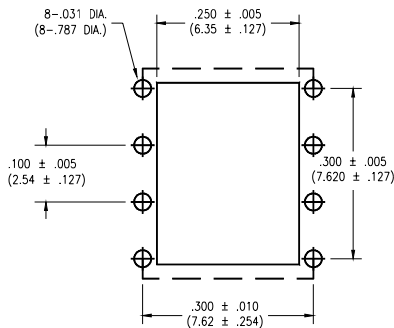

**BOTTOM VIEW/
BOARD PATTERN**

8 PIN SURFACE MOUNT DEVICE

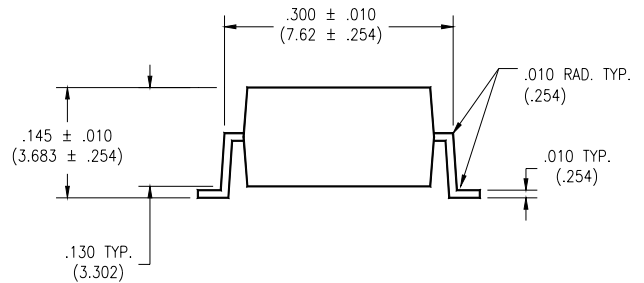

END VIEW

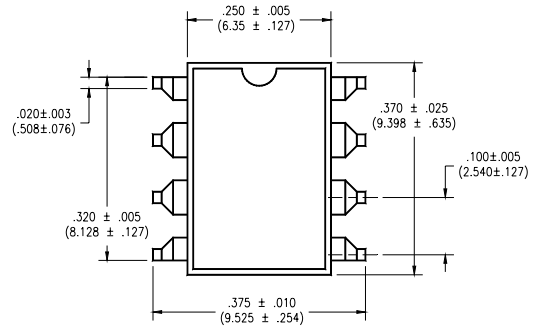

TOP VIEW

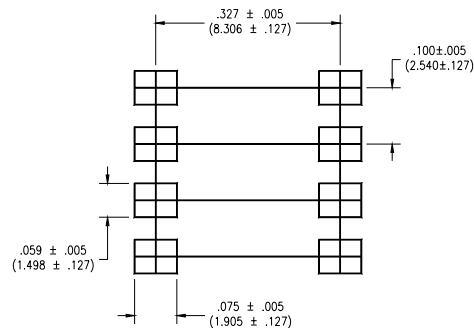

**BOTTOM VIEW/
BOARD PATTERN**