

### General Description

The AAT3192 and AAT3193 are charge-pump based, current-sink white LED drivers capable of driving one to three LEDs up to 30mA, each. They automatically switch between 1x mode and 2x mode to maintain the highest efficiency and optimal LED current accuracy and matching.

The AAT3192/93 charge pump's 1x mode (bypass mode) has very low resistance allowing LED current regulation to be maintained with input supply voltage approaching the LED forward voltage.

The AAT3192 and the AAT3193 are available in a 2x2mm 10-lead SC70JW-10 packages.

### Features

- Drives up to 3 LEDs at up to 30mA, each
- Automatic Switching Between 1x and 2x Modes
- 0.9MHz Switching Frequency
- Linear LED Output Current Control
  - Single-wire, S<sup>2</sup>Cwire Interface
    - AAT3192/93-1: 16-step
    - AAT3192/93-2: 8-step
    - AAT3192/93-3: 4-step
  - ON/OFF or PWM Interface
    - AAT3192/93-4
- ±10% LED Output Current Accuracy
- ±3% LED Output Current Matching
- Low-current Shutdown Mode
- Built-in Thermal Protection
- Automatic Soft-start
- Available in 2x2mm SC70JW-10 Package

### Applications

- Low-cost Cordless Phone Handsets
- Low-cost Digital Cameras
- Low-cost Mobile Phone Handsets
- Low-cost MP3 and PMP Players

### Typical Application

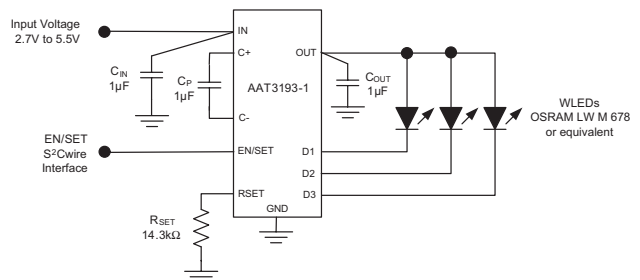
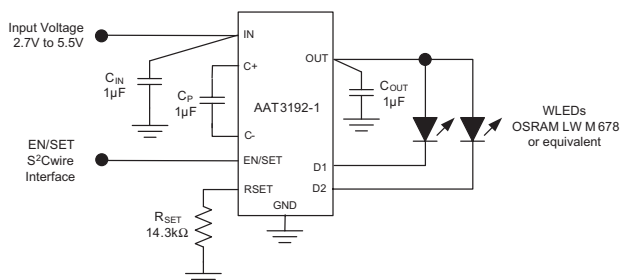

### Pin Descriptions

Pin	Symbol		Description
	AAT3192	AAT3193	
1	N/C	D1	AAT3192: No connection. AAT3193: LED1 current sink input. D1 is the input of LED1 current sink. Connect LED1's anode to OUT and its cathode to D1.
2	OUT		Charge pump output. OUT is the output of the charge pump. Bypass OUT to GND with a 1 $\mu$ F or larger ceramic capacitor.
3	C-		Charge pump capacitor negative node.
4	C+		Charge pump capacitor positive node. Connect a 1 $\mu$ F ceramic capacitor between C+ and C-.
5	IN		Power source input. Connect IN to the power source, typically the battery. Bypass IN to GND with a 1 $\mu$ F or larger ceramic capacitor.
6	EN/SET (AAT3192/93-1/-2/-3)		LED enable and serial control input. EN/SET is the ON/OFF control for the LED and the S <sup>2</sup> Cwire digital input for the AAT3192/93-1/-2/-3 to control serially the LED brightness according to the maximum current set by R <sub>SET</sub> .
	EN/PWM (AAT3192/93-4)		LED ON/OFF and PWM control input. This logic input controls the LED outputs for the AAT3192/93-4. Alternatively, a PWM signal from a GPIO or an equivalent signal from a separate controller can be used to control LED output current linearly. A PWM signal, ranging from 10% to 100% duty cycle, controls the LED current linearly between ZS and FS.
7	RSET		A 1% tolerance resistor from this pin to GND sets the maximum LED current level. For optimal LED output current accuracy and matching in the AAT3192/93-1/-2/-4, a 14.3k $\Omega$ resistor sets each full-scale output current to 20mA, maximum. For the AAT3192/93-3, a 10.7k $\Omega$ resistor is recommended.
8	GND		Ground. Connect this pin to the system's ground plane.
9	D2	D3	AAT3192: LED2 Current Sink Input. D2 is the input of LED2 current sink. Connect LED2's anode to OUT and its cathode to D2.
			AAT3193: LED3 Current Sink Input. D3 is the input of LED3 current sink. Connect LED3's anode to OUT and its cathode to D3.
10	D1	D2	AAT3192: LED1 Current Sink Input. D1 is the input of LED1 current sink. Connect LED1's anode to OUT and its cathode to D1.
			AAT3193: LED2 Current Sink Input. D2 is the input of LED2 current sink. Connect LED2's anode to OUT and its cathode to D2.

### Pin Configuration

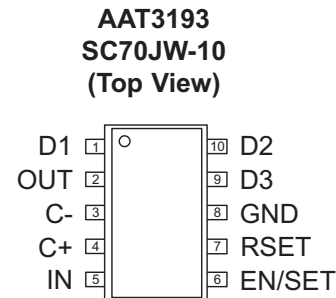
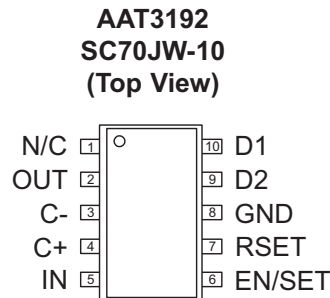

## Part Number Descriptions

Part Number	Interface	Current Control, Inverting
AAT3192IJQ-1	S <sup>2</sup> Cwire	16-step
AAT3192IJQ-2	S <sup>2</sup> Cwire	8-step
AAT3192IJQ-3	S <sup>2</sup> Cwire	4-step
AAT3192IJQ-4	PWM	Linear
AAT3193IJQ-1	S <sup>2</sup> Cwire	16-step
AAT3193IJQ-2	S <sup>2</sup> Cwire	8-step
AAT3193IJQ-3	S <sup>2</sup> Cwire	4-step
AAT3193IJQ-4	PWM	Linear

## Absolute Maximum Ratings<sup>1</sup>

Symbol	Description	Value	Units
	IN, C+, C-, OUT, D1, D2, D3, and RSET Pin Voltages to GND	-0.3 to 6.0	V
	EN/SET or EN/PWM Pin Voltage to GND	-0.3 to $V_{IN} + 0.3$	V
	Operating Junction Temperature Range	-40 to 150	°C
	Maximum Soldering Temperature (at leads, 10 sec)	300	°C

## Thermal Information

Symbol	Description	Value	Units
$P_D$	Maximum Power Dissipation <sup>2,3</sup>	625	mW
$\theta_{JA}$	Maximum Thermal Resistance <sup>2</sup>	160	°C/W

1. Stresses above those listed in Absolute Maximum Ratings may cause permanent damage to the device. Functional operation at conditions other than the operating conditions specified is not implied. Only one Absolute Maximum Rating should be applied at any one time.
2. Mounted on an FR4 circuit board.
3. Derate 6.25mW/°C above 40°C ambient temperature.

### Electrical Characteristics<sup>1</sup>

IN = EN = 3.6V; C<sub>IN</sub> = 1μF; C<sub>OUT</sub> = 1μF; C<sub>CP</sub> = 1μF; R<sub>SET</sub> = 14.3kΩ; T<sub>A</sub> = -40°C to 85°C unless otherwise noted. Typical values are at T<sub>A</sub> = 25°C.

Symbol	Description	Conditions	Min	Typ	Max	Units
<b>Input Power Supply</b>						
IN	Input Voltage Range		2.7		5.5	V
I <sub>IN</sub>	Input Operating Current	EN = IN, I <sub>D1</sub> = I <sub>D2</sub> = I <sub>D3</sub> = OFF (WLED Test Mode)			5	mA
		EN = IN, I <sub>D1</sub> = I <sub>D2</sub> = I <sub>D3</sub> = FS			1.5	mA
		Operating, I <sub>D1</sub> = I <sub>D2</sub> = I <sub>D3</sub> = OPEN; IN = 5V			4.5	mA
I <sub>IN(SHDN)</sub>	Input Shutdown Current	EN/SET or EN/PWM = GND			1	μA
<b>Charge Pump Section</b>						
I <sub>OUT</sub>	OUT Maximum Output Current			100		mA
f <sub>OSC</sub>	Charge Pump Oscillator Frequency		0.65	0.9	1.15	MHz
V <sub>IN_(TH)</sub>	Charge Pump Mode Hysteresis	I <sub>D1</sub> = I <sub>D2</sub> = I <sub>D3</sub> = 20mA		115	250	mV
t <sub>OUT</sub>	Output Start-Up Time	EN/SET or EN/PWM = IN		150		μs
<b>AAT3192/93-1-/2-/4: LED Current Sink Outputs</b>						
I <sub>D_(MAX)</sub>	D1 - D3 Current Accuracy	DATA = 1; V <sub>IN</sub> - V <sub>F</sub> = 1.5V	17.6	19.6	21.6	mA
ΔI <sub>D_(MAX)</sub>	D1 - D3 Current Matching	DATA = 1; V <sub>IN</sub> - V <sub>F</sub> = 1.5V		±3		%
I <sub>D_(DATA15)</sub>	D1 - D3 Current Accuracy (AAT3192/93-1 only)	DATA = 15; V <sub>IN</sub> - V <sub>F</sub> = 1.5V	1.0	1.3	1.56	mA
I <sub>D_(DATA8)</sub>	D1 - D3 Current Accuracy (AAT3192/93-2 only)	DATA = 8; V <sub>IN</sub> - V <sub>F</sub> = 1.5V	1.0	1.3	1.56	mA
I <sub>D_(10%)</sub>	D1 - D3 Current Accuracy (AAT3192/93-4 only)	DC = 10%; V <sub>IN</sub> - V <sub>F</sub> = 1.5V		2.5		mA
V <sub>D_(TH)</sub>	D1- D3 Charge Pump Mode Transition Threshold	I <sub>D1</sub> = I <sub>D2</sub> = I <sub>D3</sub> = 20mA		150		mV

1. The AAT3192/93 are guaranteed to meet performance specification over the -40°C to 85°C operating temperature range and are assured by design, characterization and correlation with statistical process controls.

### Electrical Characteristics<sup>1</sup>

IN = EN = 3.6V; C<sub>IN</sub> = 1μF; C<sub>OUT</sub> = 1μF; C<sub>CP</sub> = 1μF; R<sub>SET</sub> = 14.3kΩ; T<sub>A</sub> = -40°C to 85°C unless otherwise noted. Typical values are at T<sub>A</sub> = 25°C.

Symbol	Description	Conditions	Min	Typ	Max	Units
<b>AAT3192/93-3: LED Current Sink Outputs</b>						
I <sub>D(MAX)</sub>	D1 - D3 Current Accuracy	R <sub>SET</sub> = 10.7kΩ; DATA = 1; V <sub>IN</sub> - V <sub>F</sub> = 1.5V	17.6	19.6	21.6	mA
ΔI <sub>D(MAX)</sub>	D1 - D3 Current Matching	R <sub>SET</sub> = 10.7 kΩ; DATA = 1; V <sub>IN</sub> - V <sub>F</sub> = 1.5V		±3		%
I <sub>D(DATA4)</sub>	D1 - D3 Current Accuracy	R <sub>SET</sub> = 10.7kΩ; DATA = 4; V <sub>IN</sub> - V <sub>F</sub> = 1.5V	0.72	0.9	1.1	mA
V <sub>D(TH)</sub>	D1- D3 Charge Pump Mode Transition Threshold	R <sub>SET</sub> = 10.7kΩ; I <sub>D1</sub> = I <sub>D2</sub> = I <sub>D3</sub> = 20mA		150		mV
<b>AAT3192/93-1/-2/-3: EN/SET and S<sup>2</sup>Cwire Control</b>						
V <sub>ENH</sub>	EN Input High Threshold Voltage		1.4			V
V <sub>ENL</sub>	EN Input Low Threshold Voltage				0.4	V
I <sub>EN(LKG)</sub>	EN Input Leakage Current	EN/SET = IN = 5V	-1		1	μA
t <sub>EN/SET(OFF)</sub>	EN/SET Input OFF Timeout				500	μs
t <sub>EN/SET(LAT)</sub>	EN/SET Input Latch Timeout				500	μs
t <sub>EN/SET(LOW)</sub>	EN/SET Input LOW Time		0.3		75	μs
t <sub>ENSET(H-MIN)</sub>	EN/SET Minimum High Time			50		ns
t <sub>ENSET(H-MAX)</sub>	EN/SET Maximum High Time				75	μs
<b>AAT3192/93-4: EN/PWM Current Control</b>						
V <sub>ENH</sub>	EN/PWM Input High Threshold Voltage		1.4			V
V <sub>ENL</sub>	EN/PWM Input Low Threshold Voltage				0.4	V
I <sub>EN(LKG)</sub>	EN/PWM Input Leakage Current	EN/PWM = IN = 5V	-1		1	μA
t <sub>PWM(ON)</sub>	PWM Control Turn-on Delay			2		μs
t <sub>EN/PWM</sub>	EN/PWM Input OFF Timeout		0.15		1	ms
f <sub>PWM</sub>	PWM Control Frequency	Duty Cycle = 80%			50	kHz

1. The AAT3192/93 are guaranteed to meet performance specification over the -40°C to 85°C operating temperature range and are assured by design, characterization and correlation with statistical process controls.

### Typical Characteristics

**Operating Current (No Load) vs. Input Voltage**

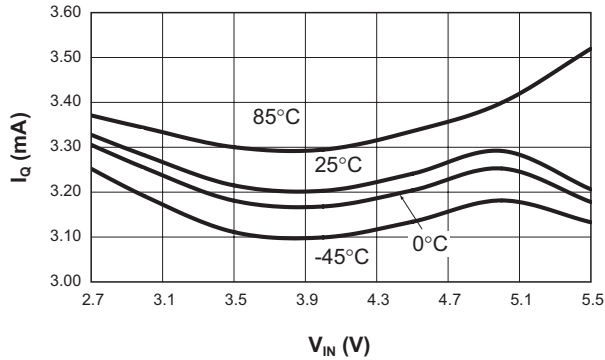

**Shutdown Current vs. Temperature**

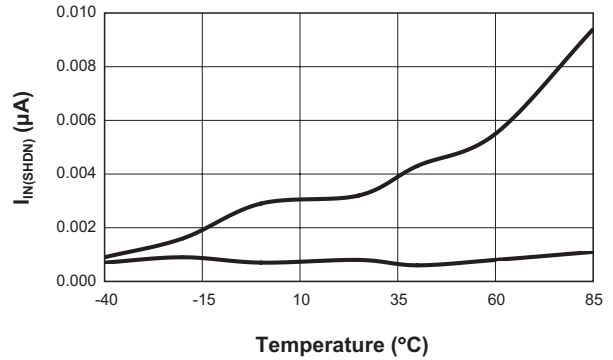

**Efficiency vs. Input Voltage**

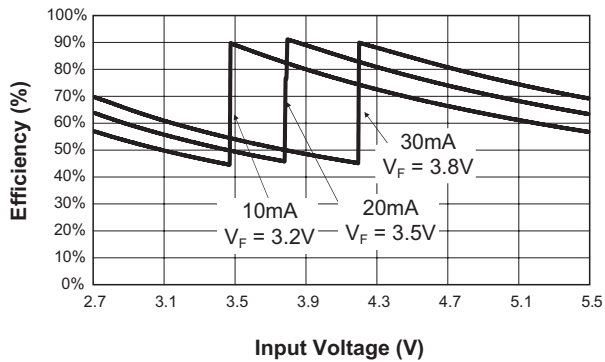

**Current Matching vs. Temperature**

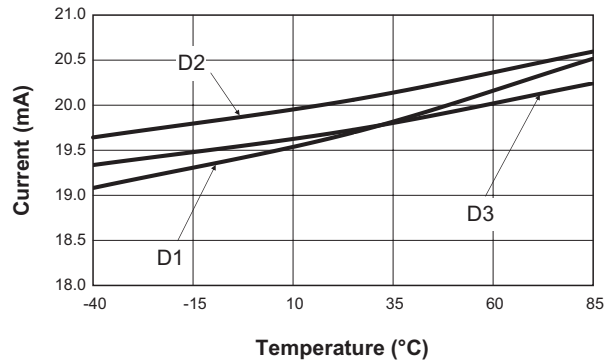

**Turn On to 2X Mode (20mA/ch)**

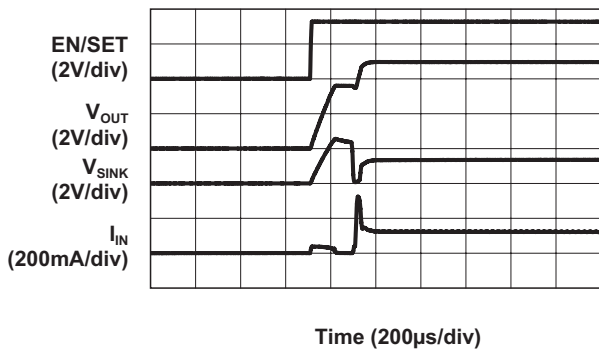

**Turn Off from 2X Mode (20mA/ch)**

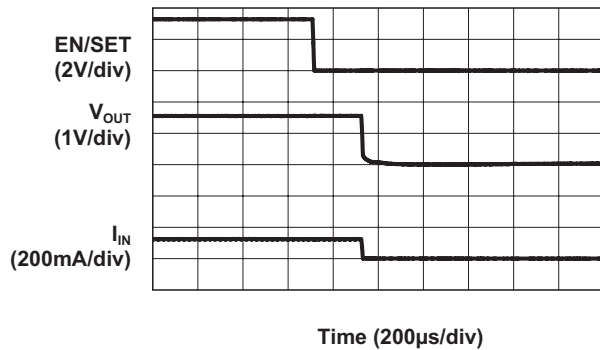

### Typical Characteristics

Turn On to 1X Mode  
( $V_{IN} = 4.2V$ ;  $20mA/ch$ )

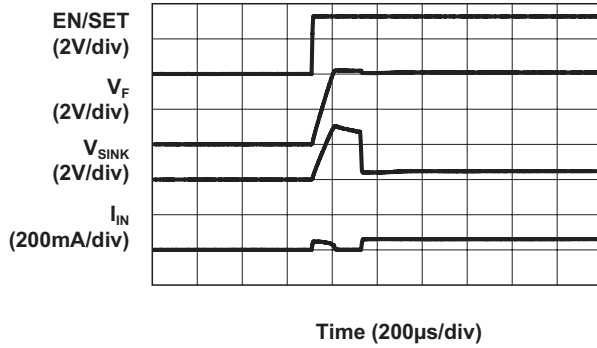

Maximum LED Current vs  $R_{SET}$

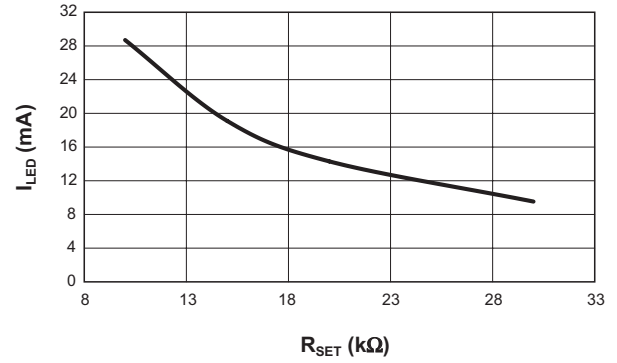

EN Input High Threshold Voltage vs. Input Voltage

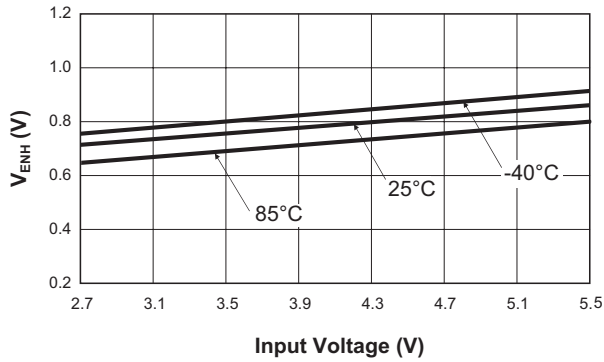

EN Input Low Threshold Voltage vs. Input Voltage

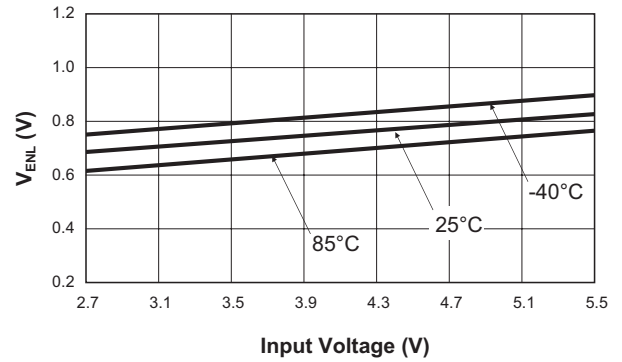

EN/SET Input Latch Timeout vs. Input Voltage

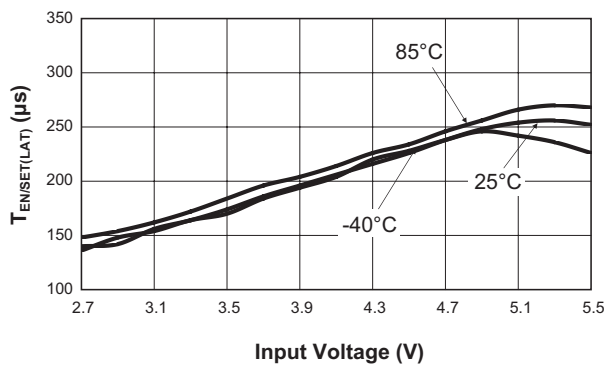

EN/SET Input OFF Timeout vs. Input Voltage

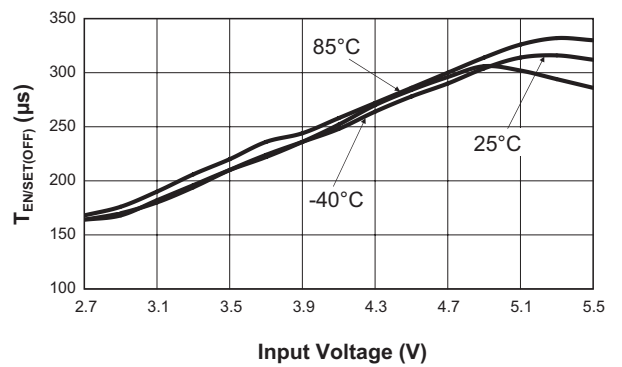

### Typical Characteristics

**Transition of LED Current  
(20mA to 1.3mA)**

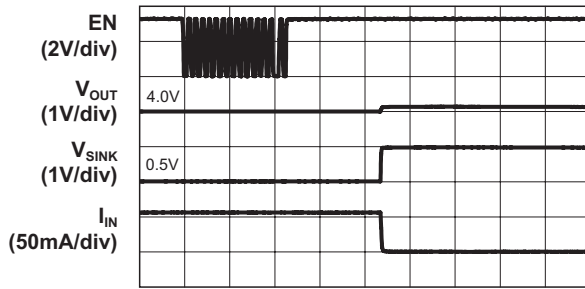

Time (100 $\mu$ s/div)

**Transition of LED Current  
(1.3mA to 20mA)**

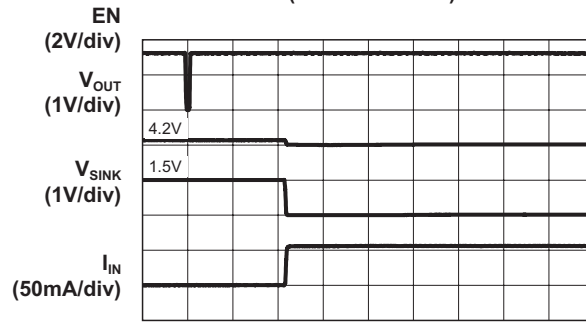

Time (100 $\mu$ s/div)

**Output Ripple Waveform  
(2X Mode; 20mA Load)**

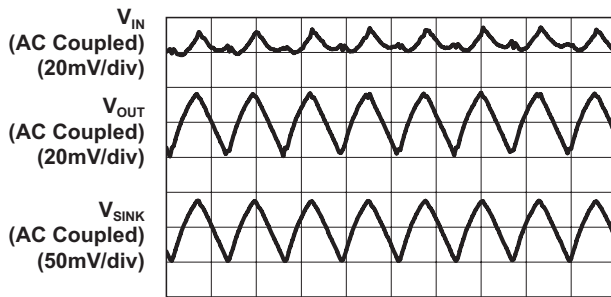

Time (1 $\mu$ s/div)

**Input Current vs. Input Voltage**

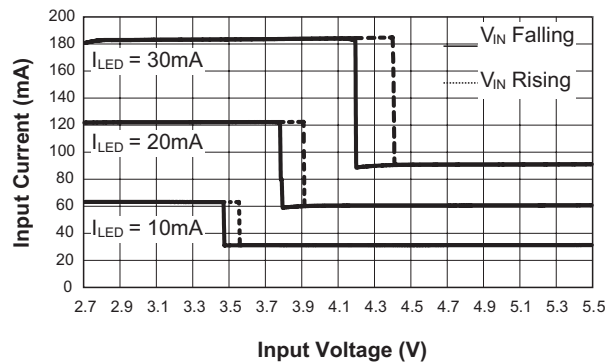



### Functional Block Diagram

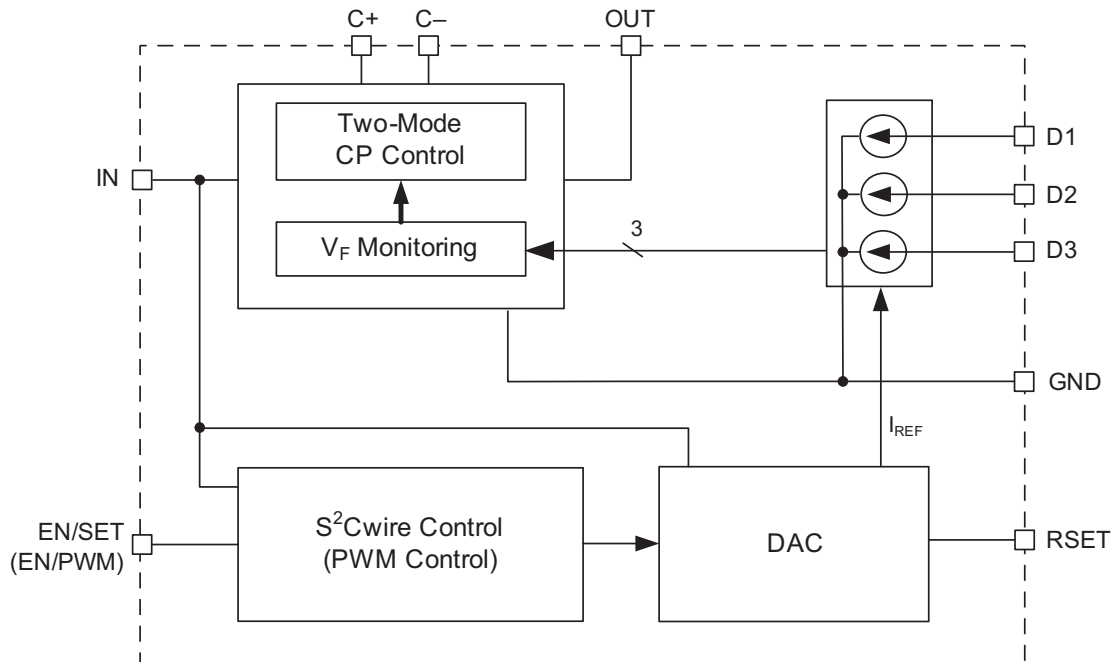

### Functional Description

The AAT3192 and AAT3193 are low-cost charge-pump solutions designed to drive up to three white LEDs. The charge pump operates from a 2.7V to 5.5V power source and converts it to voltage levels necessary to drive the LEDs. LED current is individually controlled through integrated current sinks powered from the output of the charge pump. Low 1x charge-pump output resistance and low-drop voltage current sinks allow the charge pump to stay in 1x mode with an input voltage as low as 3.75V and LED forward voltages as high as 3.5V. Once in 2x mode, the charge pump monitors the input supply voltage and automatically switches back to 1x mode when there is sufficient input voltage.

The AAT3192/93 requires only four external components: one 1 $\mu$ F ceramic capacitor for the charge pump flying capacitors ( $C_P$ ), one 1 $\mu$ F ceramic input capacitor ( $C_{IN}$ ), one 1 $\mu$ F ceramic output capacitor ( $C_{OUT}$ ) and a resistor ( $R_{SET}$ ) to set the maximum LED current. The three constant current outputs of

AAT3193 (D1 to D3) can drive three individual LEDs with a maximum current of 30mA each. AAT3192 can drive two constant output sinks (D1 and D2) with up to 30mA maximum current each. AnalogicTech's S²Cwire serial Interface enables the AAT3192/93-1/-2/-3 and changes the current sink magnitudes through the EN/SET pin. The AAT3192/93-4 uses an external PWM signal to enable the IC and control the brightness of the LEDs.

### Constant Current Control using $R_{SET}$

The maximum current is programmed by an external resistor at the RSET pin. Using a 14.3k $\Omega$  external resistor at the RSET pin, the AAT3192/93-1/-2/-4 includes an integrated serial LED current control that sets the full-scale LED current between 20mA and 0.63mA. For the AAT3192/93-3, a 10.7k $\Omega$  external resistor at the RSET pin sets the full-scale LED current between 20mA and 1.3mA. The full-scale LED current can set higher or lower than 20mA; see Table 5. For maximum accuracy, a 1% tolerance resistor is recommended.

### S<sup>2</sup>Cwire Serial Interface (AAT3192/93-1/-2/-3 only)

The LED output current of AAT3192/93 is controlled by AnalogicTech's S<sup>2</sup>Cwire serial interface. Since the LED current is programmable, no PWM or additional control circuitry is needed to control LED brightness. This feature greatly reduces the burden on a microcontroller or system IC to manage LED or display brightness, allowing the user to "set it and forget it." With its high-speed serial interface (1MHz data rate), the LED current can be changed quickly and easily. Also the non-pulsating LED current reduces system noise and improves LED reliability. The S<sup>2</sup>Cwire interface relies on the number of rising edges to the EN/SET pin to set the register. A typical write protocol is a burst of EN/SET rising edges, followed by a pause with

EN/SET held high for at least  $t_{LAT}$  (500 $\mu$ s). The programmed current is then seen at the current sink outputs. When EN/SET is held low for an amount of time longer than  $t_{OFF}$  (500 $\mu$ s), the AAT3192/93 enters into shutdown mode and draws less than 1 $\mu$ A from the input and the internal data register is reset to zero.

The AAT3192/93-1/2/3's serial interface reduces the LED current on each rising pulse of the enable input. If the AAT3192/93 is in shutdown, the first rising edge of the EN/SET input turns on the LED driver to the maximum current. Successive rising edges decrease the LED current as shown in Table 1 and Figure 2 for the AAT3192/93-1. For the AAT3192/93-2, Table 2 and Figure 3 illustrate an 8-step LED current control profile. For the AAT3192/93-3, Table 3 and Figure 4 illustrate a 4-step LED current control profile.

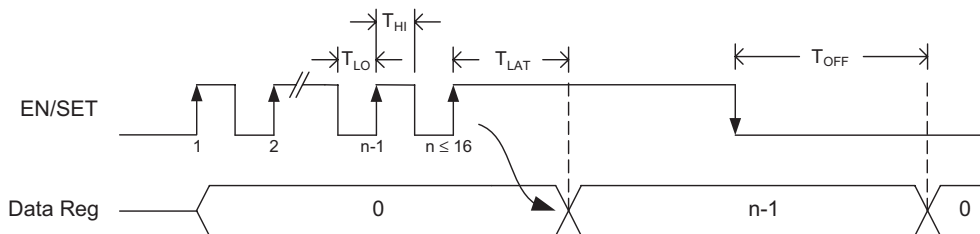

Figure 1. S<sup>2</sup>C Serial Interface Timing

Data	EN Rising Edges	D1-D3 Current (mA)
1	1	20
2	2	18.7
3	3	17.3
4	4	16
5	5	14.7
6	6	13.3
7	7	12
8	8	10.7
9	9	9.3
10	10	8
11	11	6.7
12	12	5.3
13	13	4
14	14	2.7
15	15	1.3
16	16	0.63

Table 1: AAT3192/93-1 LED Current Settings

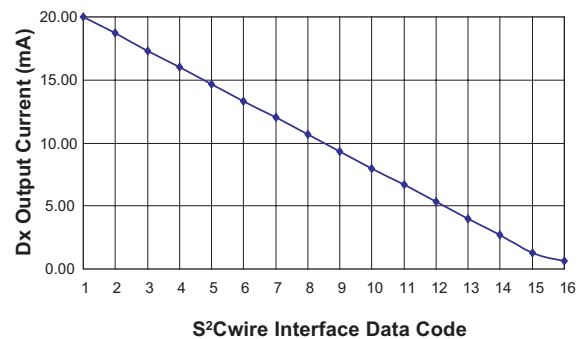
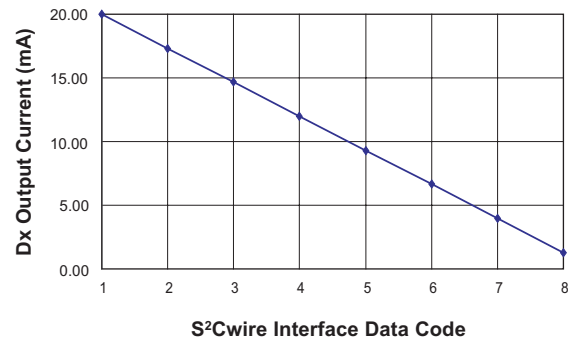

Figure 2: AAT3192/93-1 Current Control Profile

Data	EN Rising Edges	D1-D3 Current (mA)
1	1	20
2	2	17.3
3	3	14.7
4	4	12
5	5	9.3
6	6	6.7
7	7	4
8	8	1.3

**Table 2: AAT3192/93-2 LED Current Settings**



**Figure 3: AAT3192/93-2 Current Control Profile**

Data	EN Rising Edges	D1-D3 Current (mA)
1	1	20
2	2	13.3
3	3	6.7
4	4	0.87

**Table 3: AAT3192/93-3 LED Current Settings**

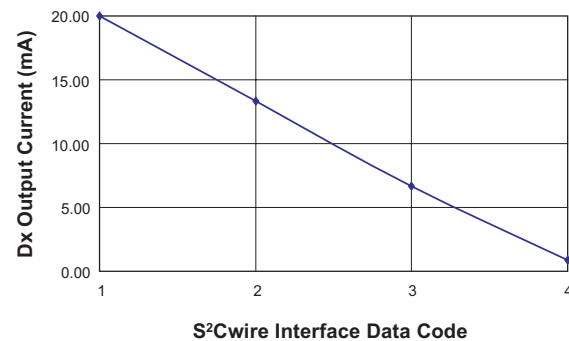

**Figure 4: AAT3192/93-3 Current Control Profile**

### PWM Control (AAT3192/93-4 only)

PWM (Pulse Width Modulation) is an industry standard technique of controlling LED brightness by modulating the conduction duty cycle of the LED current. LED brightness is determined by the average value of the PWM signal multiplied by the LED's intensity where intensity is proportional to the LED drive current. A PWM control signal can be applied into the EN/PWM pin of the AAT3192/93-4. By

changing the duty cycle of the PWM signal from 100% (logic high) to 10%, LEDs sink current can be programmed from 20mA to 2.4mA. To save power when not used, AAT3192/93-4 can be shutdown by holding the EN/PWM pin low for 1ms.

Lastly, Table 4 and Figure 5 illustrate the AAT3192/93-4's LED current control profile as a function of a PWM control signal.

EN/PWM Duty Cycle	D1-D3 Current (mA)
100%	20
90%	17.9
80%	15.9
70%	14
60%	12.1
50%	10.1
40%	8.2
30%	6.3
20%	4.3
10%	2.4

**Table 4: AAT3192/93-4 LED Current Settings**

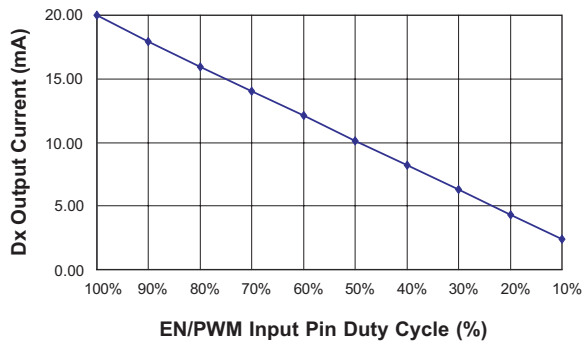

**Figure 5: AAT3192/93-4 Current Control Profile**

## Applications Information

### LED Selection

The AAT3192/93 is specifically intended for driving white LEDs. However, the device design will allow the AAT3192/93 to drive most types of LEDs with forward voltage specifications ranging from 2.2V to 4.7V. LED applications may include mixed arrangements for display backlighting, keypad display, and any other application needing a constant current sink generated from a varying input voltage. Since the D1 to D3 constant current sinks are matched with negligible supply voltage dependence, the constant current channels will be matched regardless of the specific LED forward voltage ( $V_F$ ) levels.

The low dropout current sinks in the AAT3192/93 maximize performance and make it capable of driving LEDs with high forward voltages. Multiple channels can be combined to obtain a higher LED drive current without complication.

### Constant Current Setting

The LED current is controlled by the  $R_{SET}$  resistor. For maximum accuracy, a 1% tolerance resistor is recommended. Table 5 shows the  $R_{SET}$  resistor value for AAT3193-1/2/4 for various LED full-scale current levels.

$I_{LED}$ (mA)	$R_{SET}$ (K $\Omega$ )
30	9.53
20	14.3
15	19.1
10	28.7

**Table 5: Maximum LED Current and  $R_{SET}$  Resistor Values (1% Resistor Tolerance) for the AAT3193-1/2/4.**

### Device Switching Noise Performance

The AAT3192/93 operates at a fixed frequency of approximately 1MHz to control noise and limit harmonics that can interfere with the RF operation of mobile communication devices. Back-injected noise appearing on the input pin of the charge pump is 20mV peak-to-peak, typically ten times less than inductor-based DC/DC boost converter white LED backlight solutions. The AAT3192/93 soft-start feature prevents noise transient effects

associated with inrush currents during start-up of the charge pump circuit.

### Shutdown

Since the current switches are the only power returns for all loads, there is no leakage current when all sink switches are disabled. To activate the shutdown operation, the EN/SET input for the AAT3192/93-1/2/3 should be strobed low for longer than  $t_{OFF}$  (500 $\mu$ s). For the 3192/93-4 PWM options, shutdown operation is enabled when the EN/PWM input is strobed low longer than 1ms. In this state, the AAT3192/93 typically draws less than 1 $\mu$ A from the input. Registers are reset to 0 in shutdown.

### Power Efficiency and Device Evaluation

The charge pump efficiency discussion in the following sections accounts only for efficiency of the charge pump section itself. Due to the unique circuit architecture and design of the AAT3192/93, it is very difficult to measure efficiency in terms of a percent value comparing input power over output power.

Since the AAT3192/93 outputs are pure constant current sinks and typically drive individual loads, it is difficult to measure the output voltage for a given output to derive an overall output power measurement. For any given application, white LED forward voltage levels can differ, yet the output drive current will be maintained as a constant.

This makes quantifying output power a difficult task when taken in the context of comparing to other white LED driver circuit topologies. A better way to quantify total device efficiency is to observe the total input power to the device for a given LED current drive level. The best white LED driver for a given application should be based on trade-offs of size, external component count, reliability, operating range, and total energy usage...not just % efficiency.

The AAT3192/93 efficiency may be quantified under very specific conditions and is dependent upon the input voltage versus the output voltage across the loads applied to outputs D1 through D3 (or D2 in the case of the AAT3192) for a given constant current setting. Depending on the combination of  $V_{IN}$  and voltages sensed at the current sinks, the device will operate in load switch mode. When any one of the voltages sensed at the current sinks nears dropout, the device will operate in 2X charge pump mode.

Each of these modes will yield different efficiency values. Refer to the following two sections for explanations for each operational mode.

### 1X Mode Efficiency

The AAT3192/93 1X mode is operational at all times and functions alone to enhance device power conversion efficiency when  $V_{IN}$  is higher than the voltage across the load. When in 1X mode, voltage conversion efficiency is defined as output power divided by input power.

An expression for the ideal efficiency ( $\eta$ ) in 1X charge-pump mode can be expressed as:

$$\eta = \frac{P_{OUT}}{P_{IN}} = \frac{V_F \cdot I_{LED}}{V_{IN} \cdot I_{OUT}} \cong \frac{V_F}{V_{IN}}$$

-or-

$$\eta (\%) = 100 \cdot \left( \frac{V_F}{V_{IN}} \right)$$

### 2X Charge Pump Mode Efficiency

The AAT3192/93 contains a charge pump which will boost the input supply voltage in the event where  $V_{IN}$  is less than the voltage required to supply the output. The efficiency ( $\eta$ ) can be simply defined as a linear voltage regulator with an effective output voltage that is equal to one and two times the input voltage. Efficiency ( $\eta$ ) for an ideal 2X charge pump can typically be expressed as the output power divided by the input power.

$$\eta = \frac{P_F}{P_{IN}}$$

In addition, with an ideal 2X charge pump, the output current may be expressed as 1/3 of the input current. The expression to define the ideal efficiency ( $\eta$ ) can be rewritten as:

$$\eta = \frac{P_{OUT}}{P_{IN}} = \frac{V_F \cdot I_{LED}}{V_{IN} \cdot 2I_{OUT}} = \frac{V_F}{2V_{IN}}$$

-or-

$$\eta (\%) = 100 \cdot \left( \frac{V_F}{2V_{IN}} \right)$$

For a charge pump with an output of 5V and a nominal input of 3.5V, the theoretical efficiency is 71%.

Due to internal switching losses and IC quiescent current consumption, the actual efficiency can be measured at 90%. Efficiency will decrease substantially as load current drops below 1mA or when the voltage level at  $V_{IN}$  approaches the voltage level at  $V_{OUT}$ .

### Additional Applications

The current sinks of the AAT3192 and the AAT3193 can be combined to drive higher current levels through a single LED. As an example, a single LED can be driven at 60mA total by combining together the D1-D3 outputs.

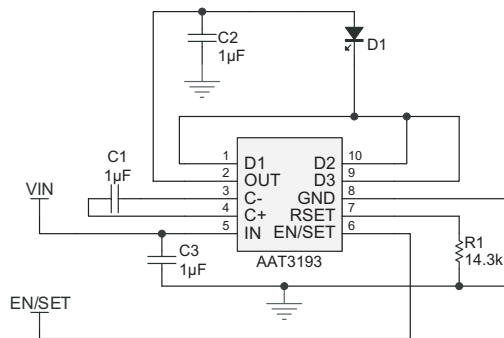

**Figure 6: Higher Current, Single LED Application.**

For lower-cost applications, the flying capacitor can be removed. This will force AAT3192/93 to operate in 1X mode. To maintain regulated LED current, the input supply voltage has to be higher than the charge-pump's dropout voltage in 1X mode.

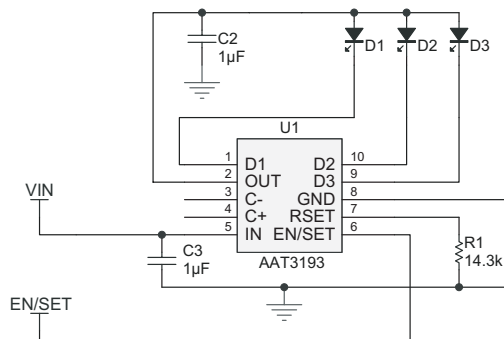

**Figure 7: Lower Cost 1X Mode Application.**

### Capacitor Selection

Careful selection of the three external capacitors  $C_{IN}$ ,  $C_P$ , and  $C_{OUT}$  is important because they will affect turn-on time, output ripple, and transient per-

formance. Optimum performance will be obtained when low equivalent series resistance (ESR) ceramic capacitors are used; in general, low ESR may be defined as less than 100mΩ. A value of 1µF for all four capacitors is a good starting point when choosing capacitors. If the constant current sinks are only programmed for light current levels, then the capacitor size may be decreased.

### Capacitor Characteristics

Ceramic composition capacitors are highly recommended over all other types of capacitors for use with the AAT3192/93. Ceramic capacitors offer many advantages over their tantalum and aluminum electrolytic counterparts. A ceramic capacitor typically has very low ESR, is lowest cost, has a smaller PCB footprint, and is non-polarized. Low ESR ceramic capacitors help maximizing charge pump transient response. Since ceramic capacitors are non-polarized, they are not prone to incorrect connection damage.

### Equivalent Series Resistance

ESR is an important characteristic to consider when selecting a capacitor. ESR is a resistance internal to a capacitor that is caused by the leads, internal connections, size or area, material composition, and ambient temperature. Capacitor ESR is typically measured in milliohms for ceramic capacitors and can range to more than several ohms for tantalum or aluminum electrolytic capacitors.

### Ceramic Capacitor Materials

Ceramic capacitors less than 0.1µF are typically made from NPO or C0G materials. NPO and C0G materials generally have tight tolerance and are very stable over temperature. Larger capacitor values are usually composed of X7R, X5R, Z5U, or Y5V dielectric materials. Large ceramic capacitors (i.e., larger than 2.2µF) are often available in low cost Y5V and Z5U dielectrics, but capacitors larger than 1µF are not typically required for AAT3192/93 applications.

Capacitor area is another contributor to ESR. Capacitors that are physically large will have a lower ESR when compared to an equivalent material smaller capacitor. These larger devices can improve circuit transient response when compared to an equal value capacitor in a smaller package size.

### Evaluation Board Schematic

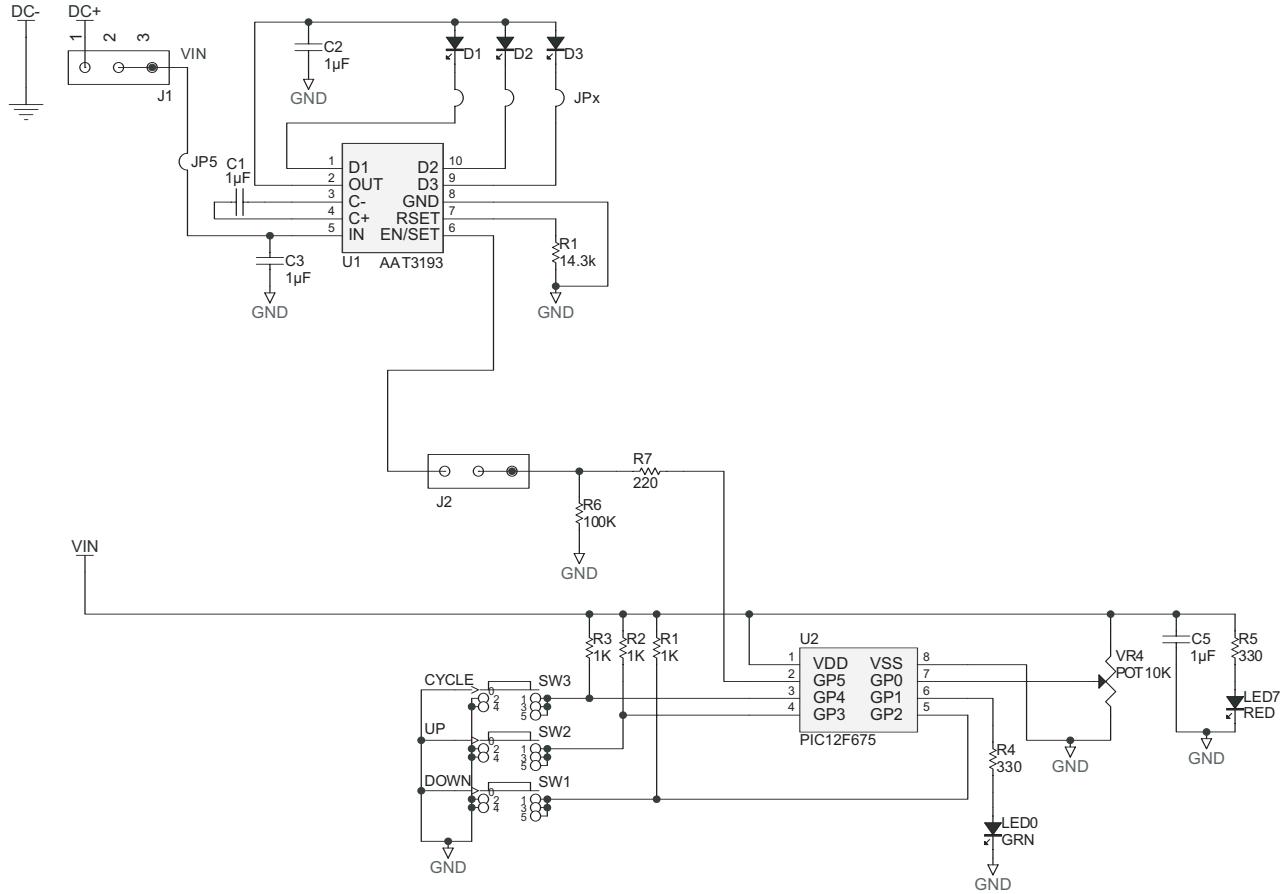

### Evaluation Board Layout

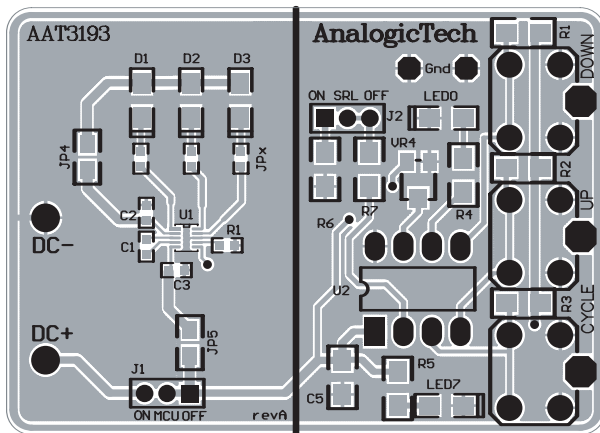

Figure 8: AAT3193 Evaluation Board Top Side Layout.

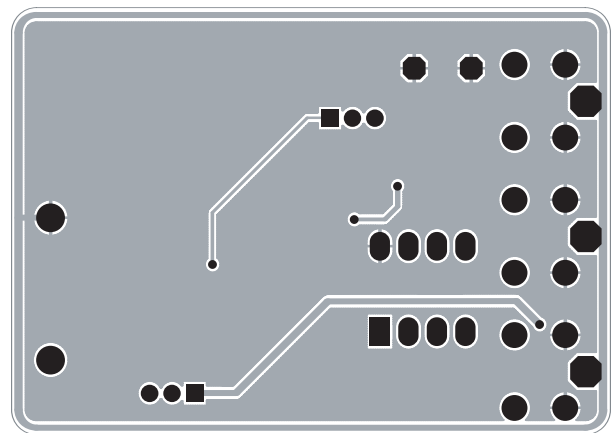

Figure 9: AAT3193 Evaluation Board Bottom Side Layout.

## Ordering Information

Package	Interface	Current Control, Inverting	Marking	Part Number (Tape and Reel)
SC70JW-10	S <sup>2</sup> Cwire	16-step		AAT3192IJQ-1-T1
SC70JW-10	S <sup>2</sup> Cwire	8-step		AAT3192IJQ-2-T1
SC70JW-10	S <sup>2</sup> Cwire	4-step		AAT3192IJQ-3-T1
SC70JW-10	PWM	Linear		AAT3192IJQ-4-T1
SC70JW-10	S <sup>2</sup> Cwire	16-step	XGXYY	AAT3193IJQ-1-T1
SC70JW-10	S <sup>2</sup> Cwire	8-step		AAT3193IJQ-2-T1
SC70JW-10	S <sup>2</sup> Cwire	4-step		AAT3193IJQ-3-T1
SC70JW-10	PWM	Linear		AAT3193IJQ-4-T1



All AnalogicTech products are offered in Pb-free packaging. The term “Pb-free” means semiconductor products that are in compliance with current RoHS standards, including the requirement that lead not exceed 0.1% by weight in homogeneous materials. For more information, please visit our website at <http://www.analogictech.com/pbfree>.

1. XYY = assembly and date code.  
 2. Sample stock is generally held on part numbers listed in **BOLD**.



### Package Information

#### SC70JW-10

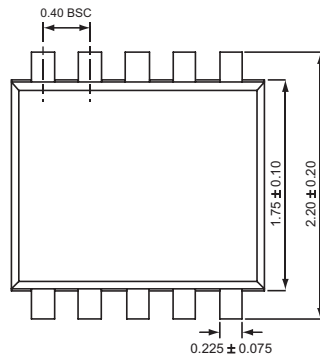

Top View

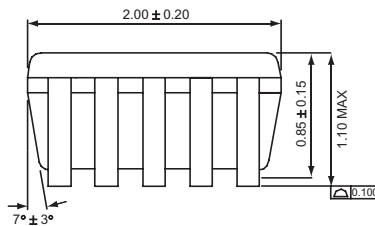

Side View

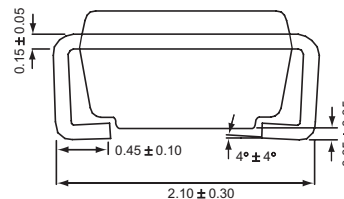

End View

All dimensions in millimeters.

© Advanced Analogic Technologies, Inc.

AnalogicTech cannot assume responsibility for use of any circuitry other than circuitry entirely embodied in an AnalogicTech product. No circuit patent licenses, copyrights, mask work rights, or other intellectual property rights are implied. AnalogicTech reserves the right to make changes to their products or specifications or to discontinue any product or service without notice. Except as provided in AnalogicTech's terms and conditions of sale, AnalogicTech assumes no liability whatsoever, and AnalogicTech disclaims any express or implied warranty relating to the sale and/or use of AnalogicTech products including liability or warranties relating to fitness for a particular purpose, merchantability, or infringement of any patent, copyright or other intellectual property right. In order to minimize risks associated with the customer's applications, adequate design and operating safeguards must be provided by the customer to minimize inherent or procedural hazards. Testing and other quality control techniques are utilized to the extent AnalogicTech deems necessary to support this warranty. Specific testing of all parameters of each device is not necessarily performed. AnalogicTech and the AnalogicTech logo are trademarks of Advanced Analogic Technologies Incorporated. All other brand and product names appearing in this document are registered trademarks or trademarks of their respective holders.

**Advanced Analogic Technologies, Inc.**  
 830 E. Arques Avenue, Sunnyvale, CA 94085  
 Phone (408) 737-4600  
 Fax (408) 737-4611