

MODEL 78

1-1/4" Rectangular

Multiturn

Cermet Trimming

Potentiometer

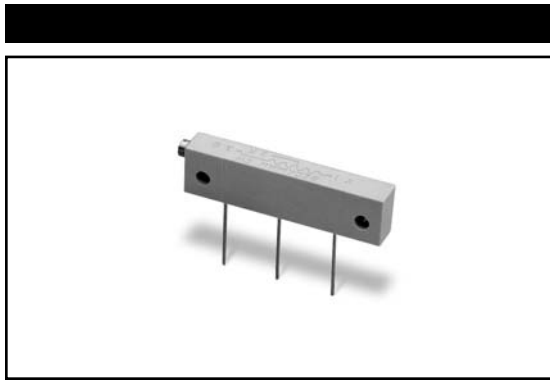

1

ELECTRICAL

Standard Resistance Range, Ohms	10 to 2Meg
Standard Resistance Tolerance	±10% (<100 Ohms = ±20%)
Input Voltage, Maximum	300 Vdc or rms not to exceed power rating
Slider Current, Maximum	100mA or within rated power, whichever is less
Power Rating, Watts	1.0 at 70°C derating to 0 at 125°C
End Resistance, Maximum	2 Ohms
Actual Electrical Travel, Turns, Nominal	22
Dielectric Strength	500 Vrms
Insulation Resistance, Minimum	1,000 Megohms
Resolution	Essentially infinite
Contact Resistance Variation, Maximum	1% or 1 Ohm, whichever is greater

ENVIRONMENTAL

Seal	85°C Fluorinert® (No Leaks)
Temperature Coefficient, Maximum	±100ppm/°C
Operating Temperature Range	-55°C to +125°C
Thermal Shock	5 cycles, -55°C to +125°C (1% ΔRT, 1% ΔVR)
Moisture Resistance	Ten 24 hour cycles (1% ΔRT, IR 1,000 Megohms Min.)
Shock, 6ms Sawtooth	100G's (1% ΔRT, 1% ΔVR)
Vibration	20G's, 10 to 2,000 Hz (1% ΔRT, 1% ΔVR)
High Temperature Exposure	250 hours at 125°C (2% ΔRT, 2% ΔVR)
Rotational Life	200 cycles (3% ΔRT)
Load Life at 0.5 Watts	1,000 hours at 70°C (2% ΔRT)
Resistance to Solder Heat	260°C for 10 sec. (1% ΔRT)

MECHANICAL

Mechanical Stops	Clutch Action, both ends
Torque, Starting Maximum	5oz.-in. (0.035 N-m)
Weight, Nominal	.09 oz. (2.6 grams)

Fluorinert® is a registered trademark of 3M Company.
Specifications subject to change without notice.



SIDE ADJUSTMENT (Inch/mm)

Model 78P

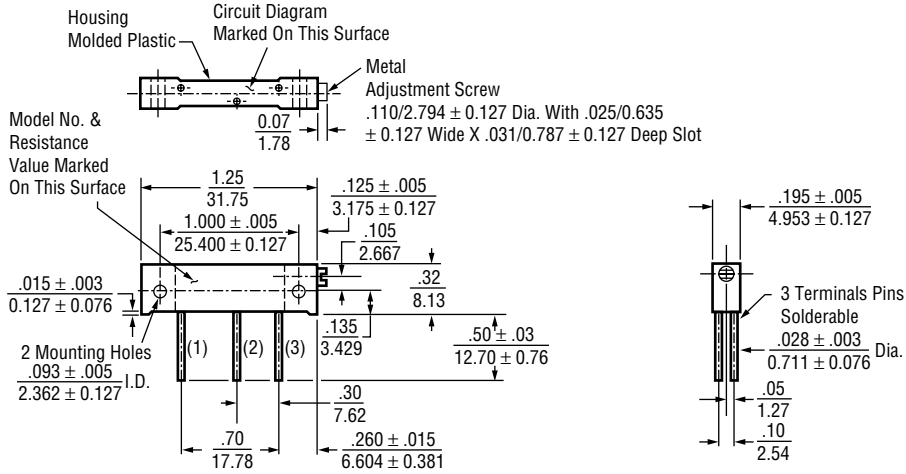

Note: Model 78P dimensions applicable to all other models except as noted.

Model 78L

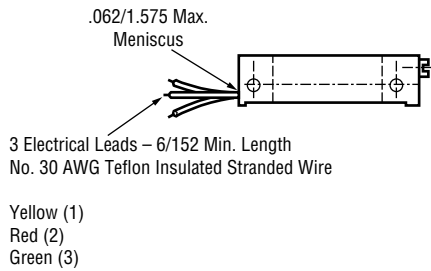

Model 78S

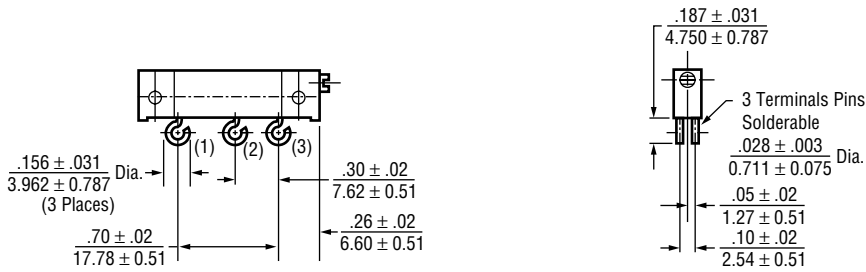

PANEL MOUNT ADAPTER (Inch/mm)

1

Model 56BW (Adapter Only)

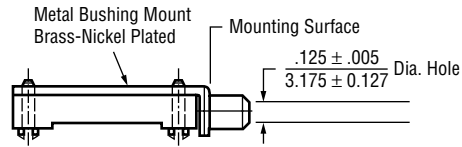

Use .22/5.613 Dia. Min. Mounting Hole

Lock Washer, Panel Nut, Sealing Washer & Mounting Screws Provided

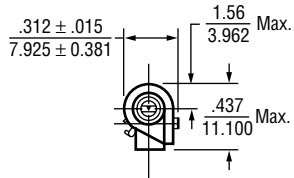

Model 78LBW (Adapter Pre-Assembled with Trimmer)

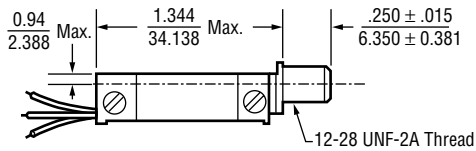

Model 78SBW (Adapter Pre-Assembled with Trimmer)

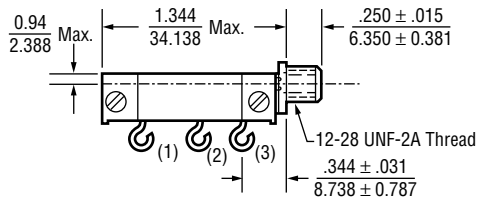

STANDARD RESISTANCE VALUES, OHMS

10	200	5K	50K	500K
20	500	10K	100K	1Meg
50	1K	20K	200K	2Meg
100	2K	25K	250K	

PACKAGING

Standard: Boxes
Capacity = 25 Units

ORDERING INFORMATION

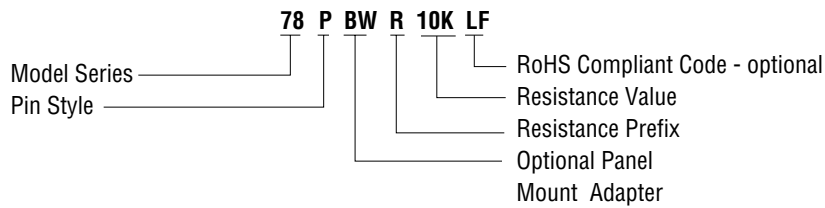

Note: Use '56BW' to order panel mount adapter without trimmer

CIRCUIT DIAGRAM

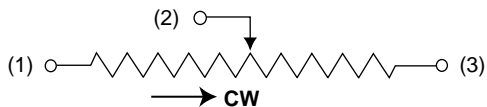

NOTES

Metric equivalents, based on 1 inch = 25.4mm are rounded to the same number of significant figures as in the original English units and are provided for general information only.

Tolerances unless otherwise specified:
Linear = ± .01 inches (.25mm)
Angular = ± 2 degrees

