

Diode Module with Brake

Diode:1600V / 100A, IGBT:1400A/75A

■ Features

- Compact Package
- P.C. Board Mount Module
- Converter Diode Bridge Dynamic Brake Circuit

■ Applications

- Inverter for Motor Drive
- AC and DC Servo Drive Amplifier
- Uninterruptible Power Supply

■ Maximum ratings and characteristics

● Absolute maximum ratings (Tc=25°C unless without specified)

Item	Symbol	Condition		Rating	Unit	
Converter	Repetitive peak reverse voltage	V _{RRM}			1600	V
	Non-repetitive peak reverse voltage	V _{RSM}			1760	V
	Average output current	I _o	50Hz/60Hz sine wave Tc=110°C		100	A
	One cycle surge current	I _{FSM}	From rated load		1000	A
	Peak current	I _t	From rated load		4000	A ² s
	Operation junction temperature	T _j			-40 to +125	°C
Brake	Collector-Emitter voltage	V _{GES}			1400	V
	Gate-Emitter voltage	V _{GES}			±20	V
	Collector current	I _c	DC	Tc=25°C	75	A
				Tc=75°C	50	
		I _{cP}	1ms	Tc=25°C	150	A
				Tc=75°C	100	
	Collector power dissipation	P _c	1 device		360	W
	Repetitive peak reverse voltage	V _{RRM}			1400	V
	Operation junction temperature	T _j			+150	°C
	Storage junction temperature	T _{stg}	AC : 1 minute		-40 to +125	°C
Isolation voltage	V _{iso}	M5 screw		2500	V	
Mounting screw torque				2.0 to 2.5	N·m	

● Electrical characteristics (Tj=25°C unless otherwise specified)

Item	Symbol	Condition	Min.	Typ.	Max.	Unit	
Co.	Forward voltage	V _{FM}	Tj=25°C, I _{FM} =100A		1.30	V	
	Reverse current	I _{RRM}	Tj=150°C, V _R =V _{RRM}		20	mA	
	Zero gate voltage Collector current	I _{CES}	V _{GE} =0V. V _{CE} =1400V		1.0	mA	
	Gate-Emitter leakage current	I _{GES}	V _{CE} =0V. V _{GE} =±20V		200	nA	
Brake	Collector-Emitter saturation voltage	V _{CE(sat)}	V _{GE} =15V. I _c =50A		2.4	2.8	V
	Turn-on time	ton	V _{CC} =800V		0.35	1.2	μs
		tr	I _c =50A		0.25	0.6	
	Turn-off time	toff	V _{GE} =±15V		0.45	1.0	
		tf	R _G =25ohm		0.08	0.3	
	Reverse current	I _{RRM}				1.0	mA

● Thermal characteristics

Item	Symbol	Condition		Min.	Typ.	Max.	Unit
Thermal resistance	R _{th(j-c)}	Converter	Per total loss			0.14	°C/W
			Per each device			0.84	
		Brake IGBT (1 device)			0.55		
Thermal Resistance(Case to fine)	R _{th(c-f)}	with thermal compound				0.08	°C/W

Forward Characteristics

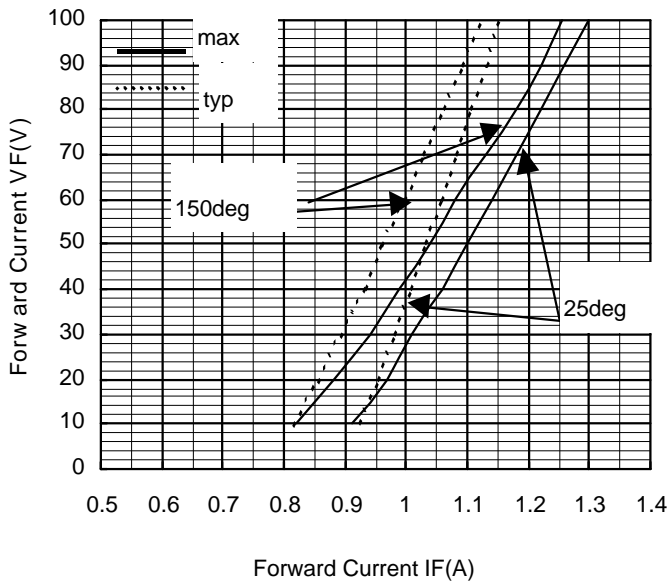

Output Current - Total Loss

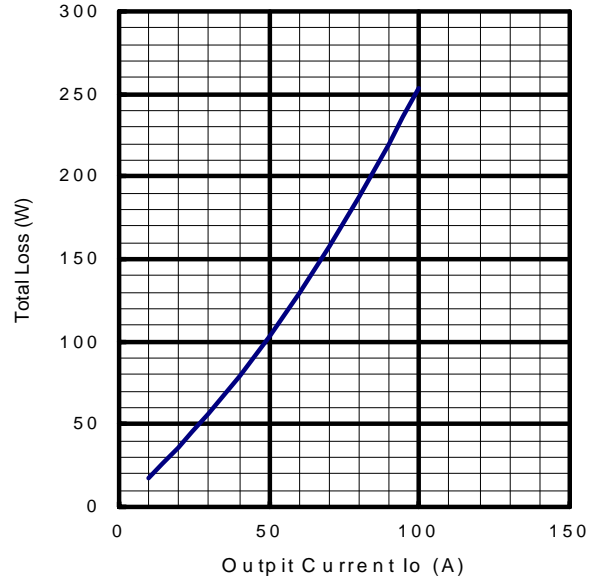

Output Current - Case Temperature

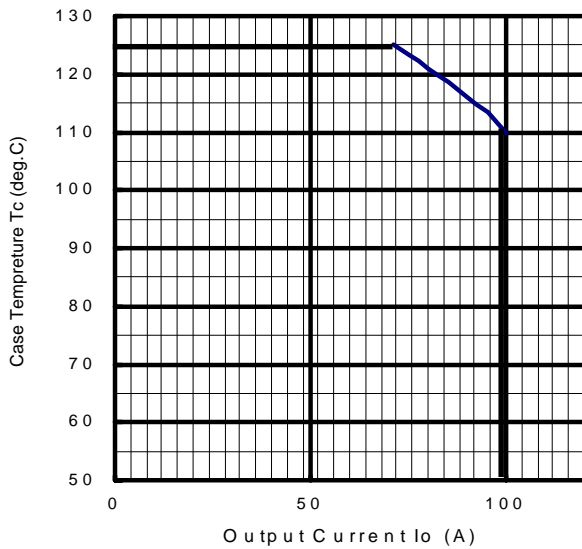

Surge Current

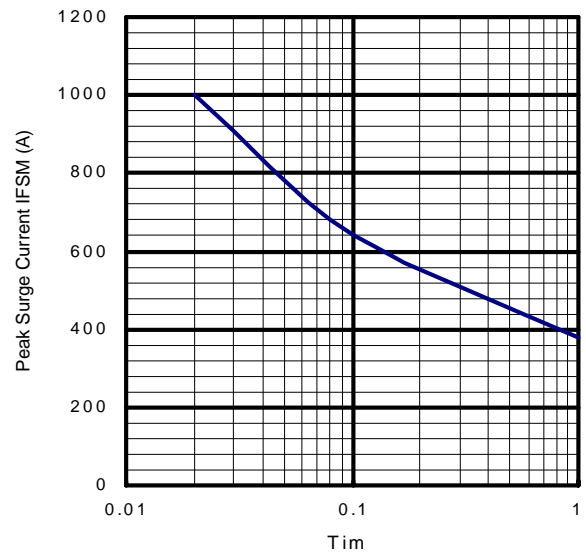

Transient Thermal Impedance

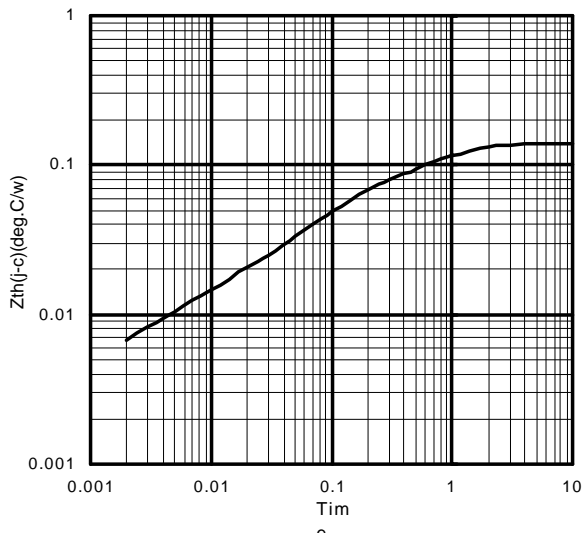

[Brake] Transient Thermal Impedance

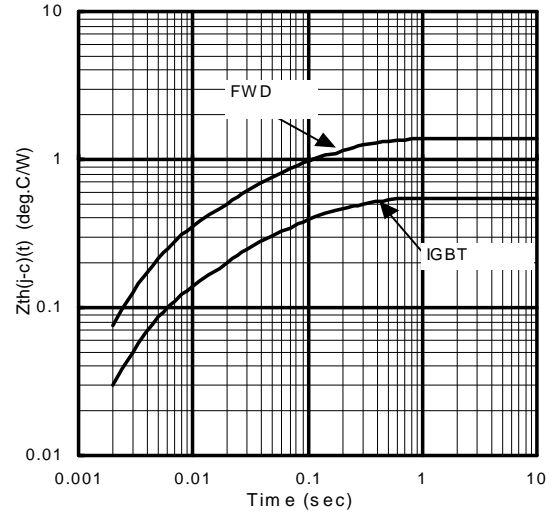

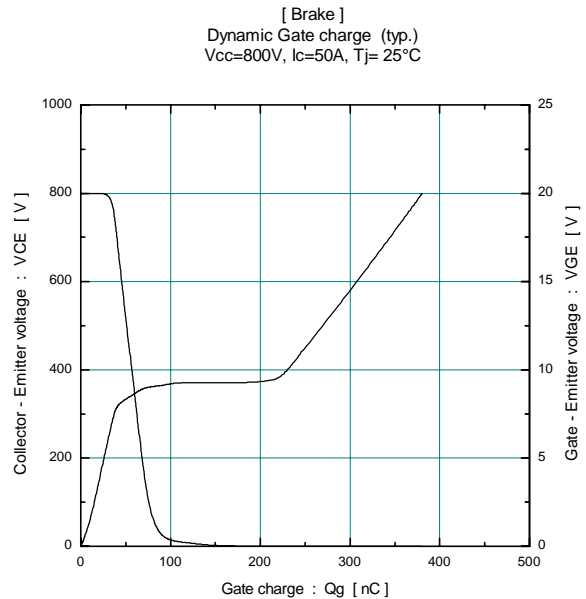
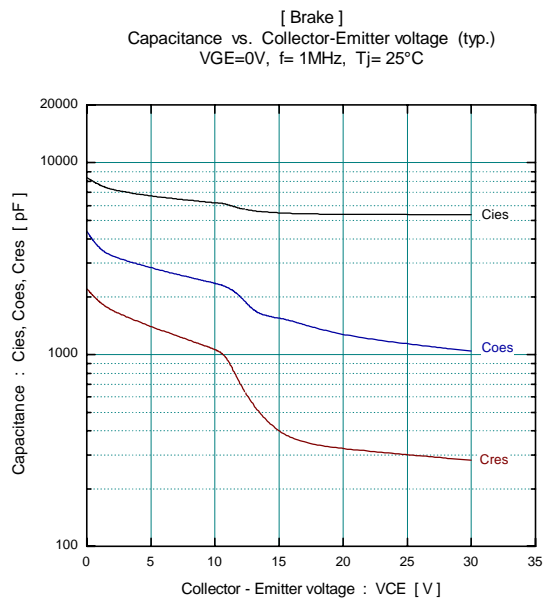
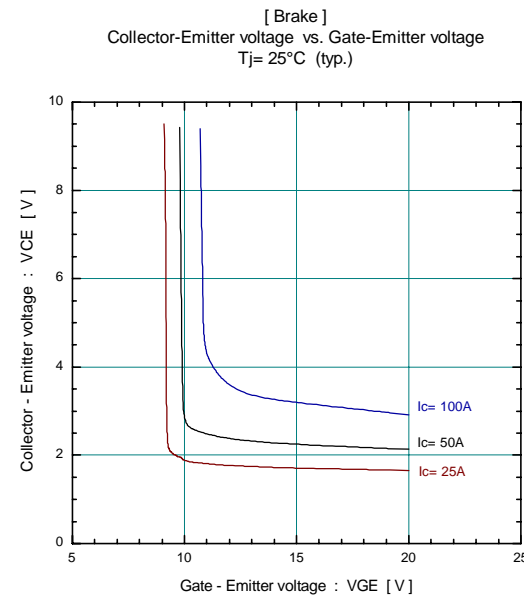
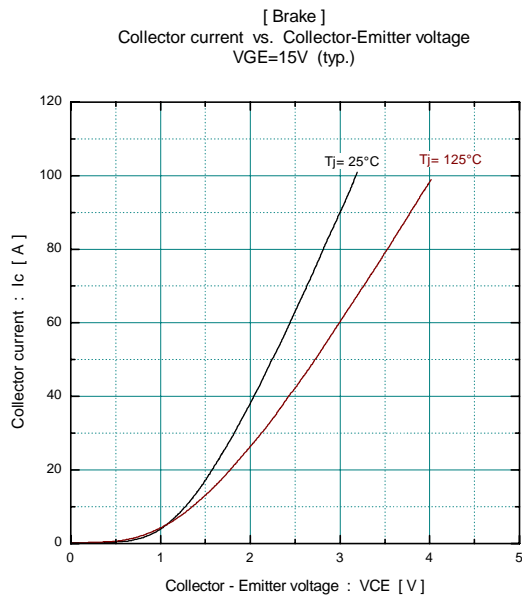
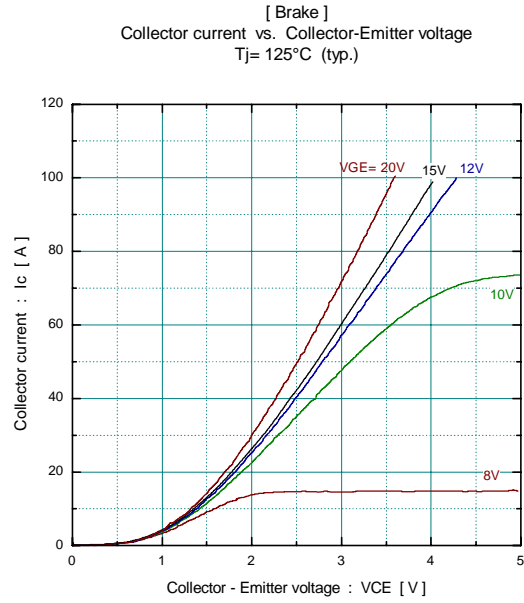
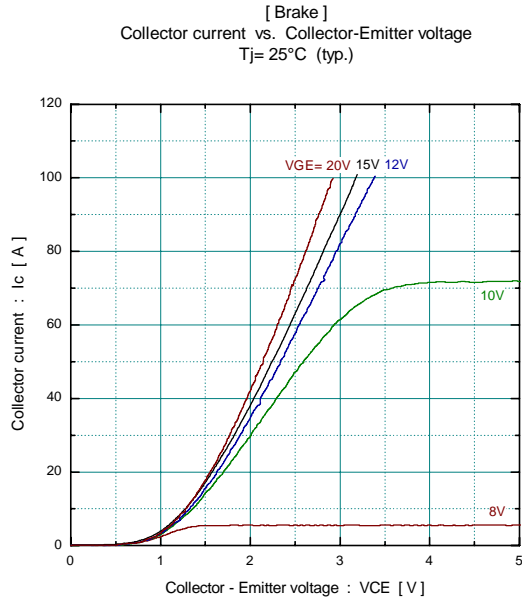

■ Outline Drawings, mm

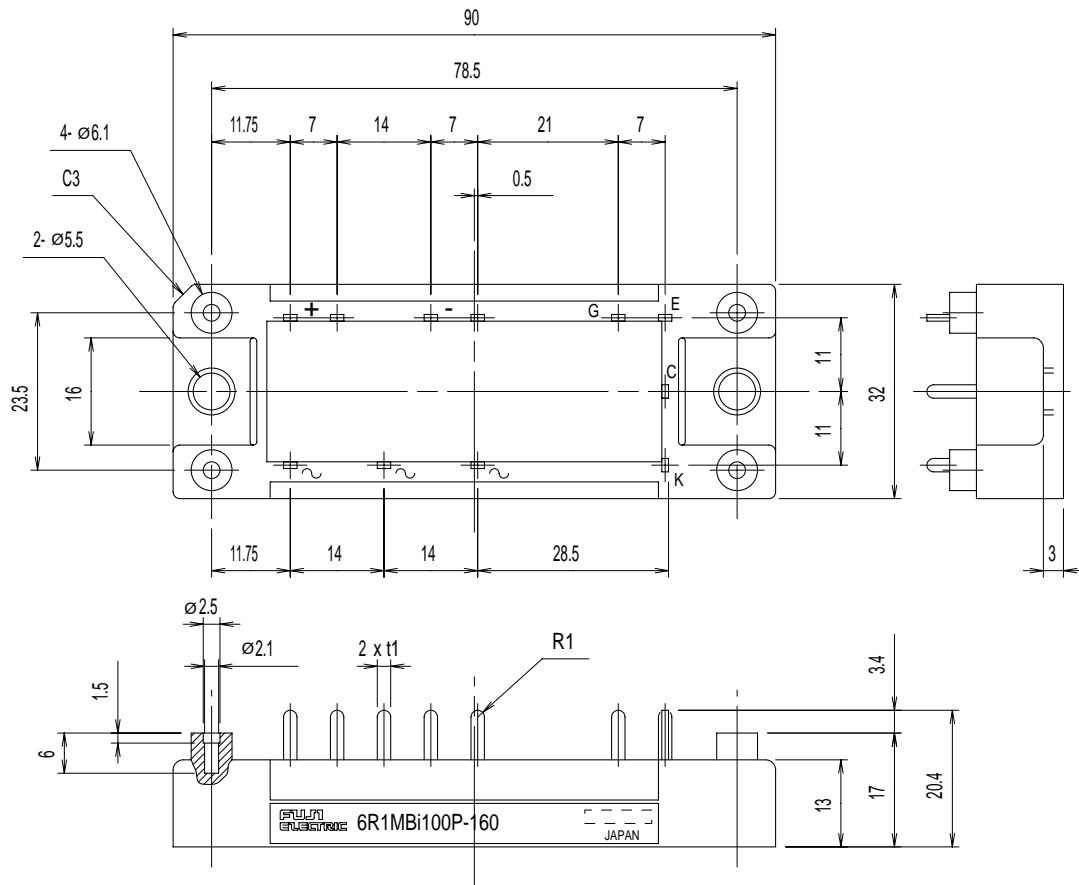

■ Equivalent Circuit Schematic

