

V_{RRM}	=	2500 V
I_{FAVM}	=	950 A
I_{FSM}	=	21 kA
V_{F0}	=	1.2 V
r_F	=	0.38 m Ω
V_{DClink}	=	1500 V

Fast Recovery Diode

5SDF 11F2501

Doc. No. 5SYA1113-04 Sep. 01

- Patented free-floating silicon technology
- Low on-state and switching losses
- Optimized for use as freewheeling diode in GTO converters
- Standard press-pack housing, hermetically cold-welded
- Cosmic radiation withstand rating

Blocking

V_{RRM}	Repetitive peak reverse voltage	2500 V	Half sine wave, $t_p = 10$ ms, $f = 50$ Hz	
I_{RRM}	Repetitive peak reverse current	≤ 50 mA	$V_R = V_{RRM}$, $T_J = 125^\circ\text{C}$	
V_{DClink}	Permanent DC voltage for 100 FIT failure rate	1500 V	100% Duty	Ambient cosmic radiation at sea level in open air.
V_{DClink}	Permanent DC voltage for 100 FIT failure rate	V	5% Duty	

Mechanical data (see Fig. 12)

F_m	Mounting force	min.	20 kN	
		max.	24 kN	
a	Acceleration: Device unclamped Device clamped		50 m/s ²	
			200 m/s ²	
m	Weight		0.46 kg	
D_s	Surface creepage distance	\geq	30 mm	
D_a	Air strike distance	\geq	20 mm	

ABB Semiconductors AG reserves the right to change specifications without notice.



On-state (see Fig. 2, 3)

I_{FAVM}	Max. average on-state current	950 A	Half sine wave, $T_c = 85^\circ\text{C}$	
I_{FRMS}	Max. RMS on-state current	1500 A		
I_{FSM}	Max. peak non-repetitive surge current	21 kA	$t_p = 10 \text{ ms}$	Before surge: $T_c = T_j = 125^\circ\text{C}$
		65 kA	$t_p = 1 \text{ ms}$	
$\int I^2 dt$	Max. surge current integral	$2.2 \cdot 10^6 \text{ A}^2\text{s}$	$t_p = 10 \text{ ms}$	After surge: $V_R \approx 0 \text{ V}$
		$2.1 \cdot 10^6 \text{ A}^2\text{s}$	$t_p = 1 \text{ ms}$	
V_F	Forward voltage drop	$\leq 1.6 \text{ V}$	$I_F = 1000 \text{ A}$	$T_j = 125^\circ\text{C}$
V_{F0}	Threshold voltage	1.2 V	Approximation for	
r_F	Slope resistance	0.38 m Ω	$I_F = 400 \dots 4000 \text{ A}$	

Turn-on (see Fig. 4, 5)

V_{fr}	Peak forward recovery voltage	$\leq 16 \text{ V}$	$di/dt = 500 \text{ A}/\mu\text{s}$, $T_j = 125^\circ\text{C}$
----------	-------------------------------	---------------------	---

Turn-off (see Fig. 6 to 11)

I_{rr}	Reverse recovery current	$\leq 550 \text{ A}$	$di/dt = 300 \text{ A}/\mu\text{s}$, $I_F = 700 \text{ A}$, $T_j = 125^\circ\text{C}$, $V_{RM} = 2600 \text{ V}$, $C_S = 2 \mu\text{F}$ (GTO snubber circuit)
Q_{rr}	Reverse recovery charge	$\leq 1200 \mu\text{C}$	
E_{rr}	Turn-off energy	$\leq 0.45 \text{ J}$	

Thermal (see Fig. 1)

T_j	Operating junction temperature range	-40...125 $^\circ\text{C}$		
T_{stg}	Storage temperature range	-40...125 $^\circ\text{C}$		
R_{thJC}	Thermal resistance junction to case	$\leq 40 \text{ K/kW}$	Anode side cooled	$F_m = 20 \dots 24 \text{ kN}$
		$\leq 40 \text{ K/kW}$	Cathode side cooled	
		$\leq 20 \text{ K/kW}$	Double side cooled	
R_{thCH}	Thermal resistance case to heatsink	$\leq 10 \text{ K/kW}$	Single side cooled	
		$\leq 5 \text{ K/kW}$	Double side cooled	

Analytical function for transient thermal impedance.

$$Z_{thJC}(t) = \sum_{i=1}^n R_i (1 - e^{-t/\tau_i})$$

i	1	2	3	4
$R_i(\text{K/kW})$	11.83	4.26	1.63	2.28
$\tau_i(\text{s})$	0.432	0.071	0.01	0.0054
$F_m = 20 \dots 24 \text{ kN}$ Double side cooled				

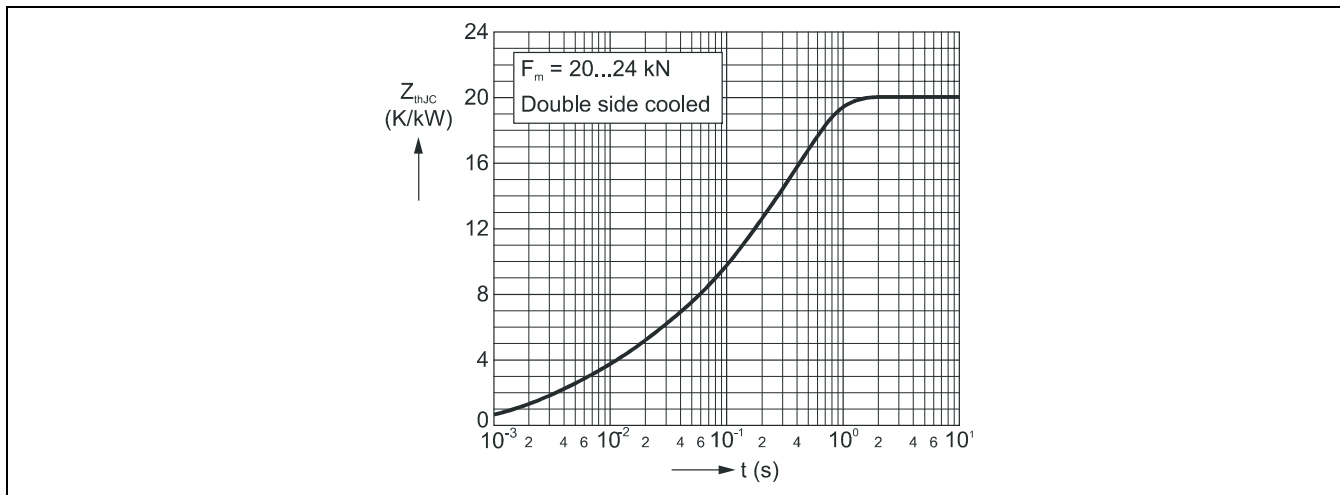

Fig. 1 Transient thermal impedance (junction-to-case) vs. time in analytical and graphical form (max. values).

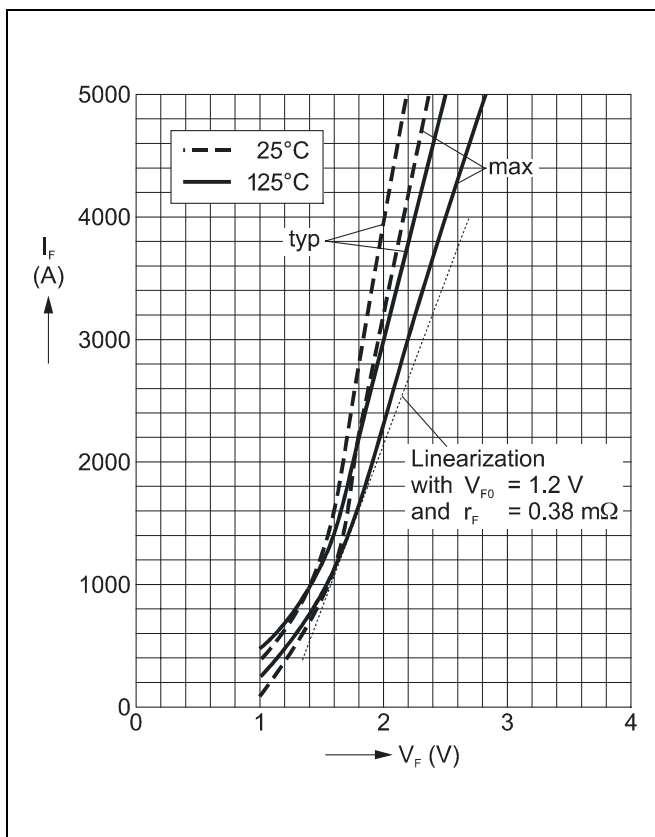

Fig. 2 Forward current vs. forward voltage (typ. and max. values) and linear approximation of max. curve at 125°C.

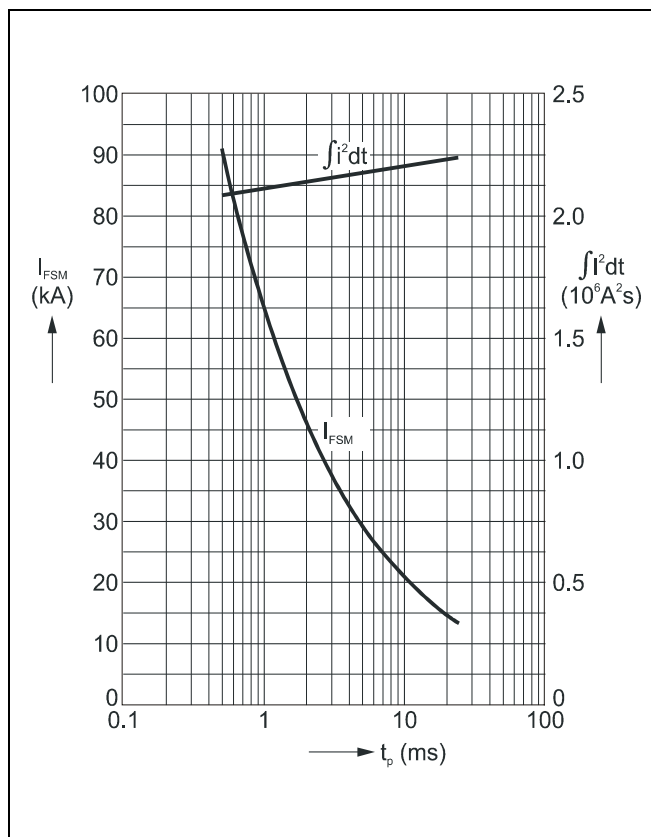

Fig. 3 Surge current and fusing integral vs. pulse width (max. values) for non-repetitive, half-sinusoidal surge current pulses.

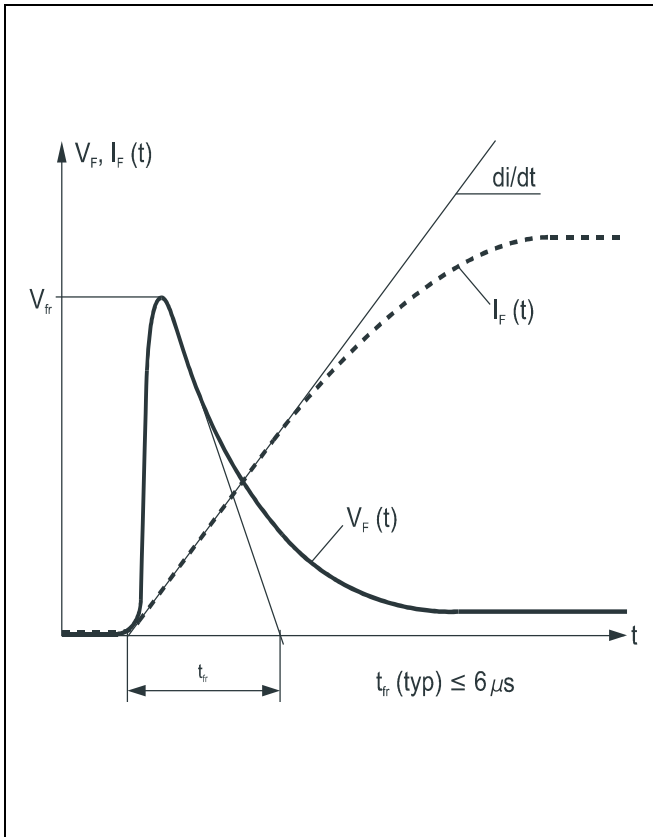

Fig. 4 Typical forward voltage waveform when the diode is turned on with a high di/dt.

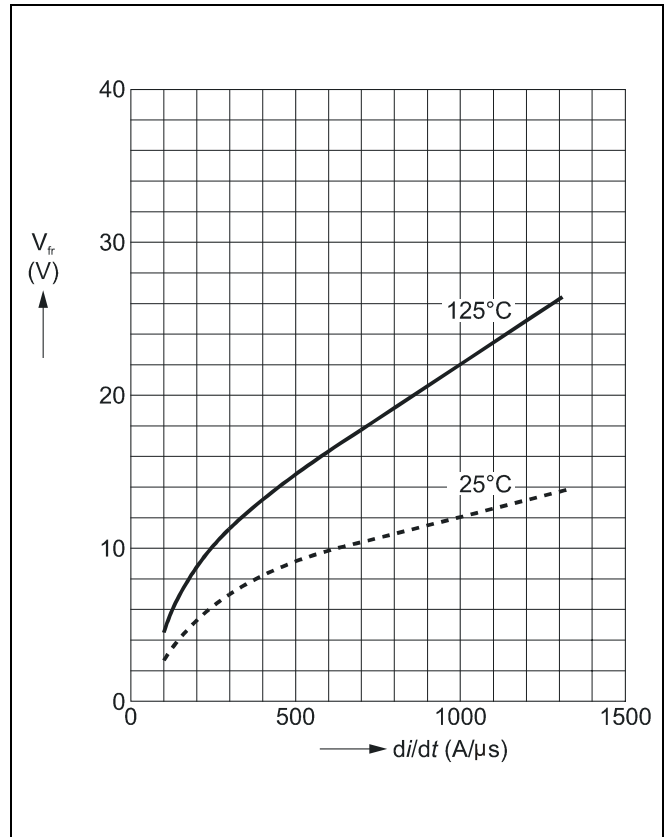

Fig. 5 Forward recovery voltage vs. turn-on di/dt (max. values).

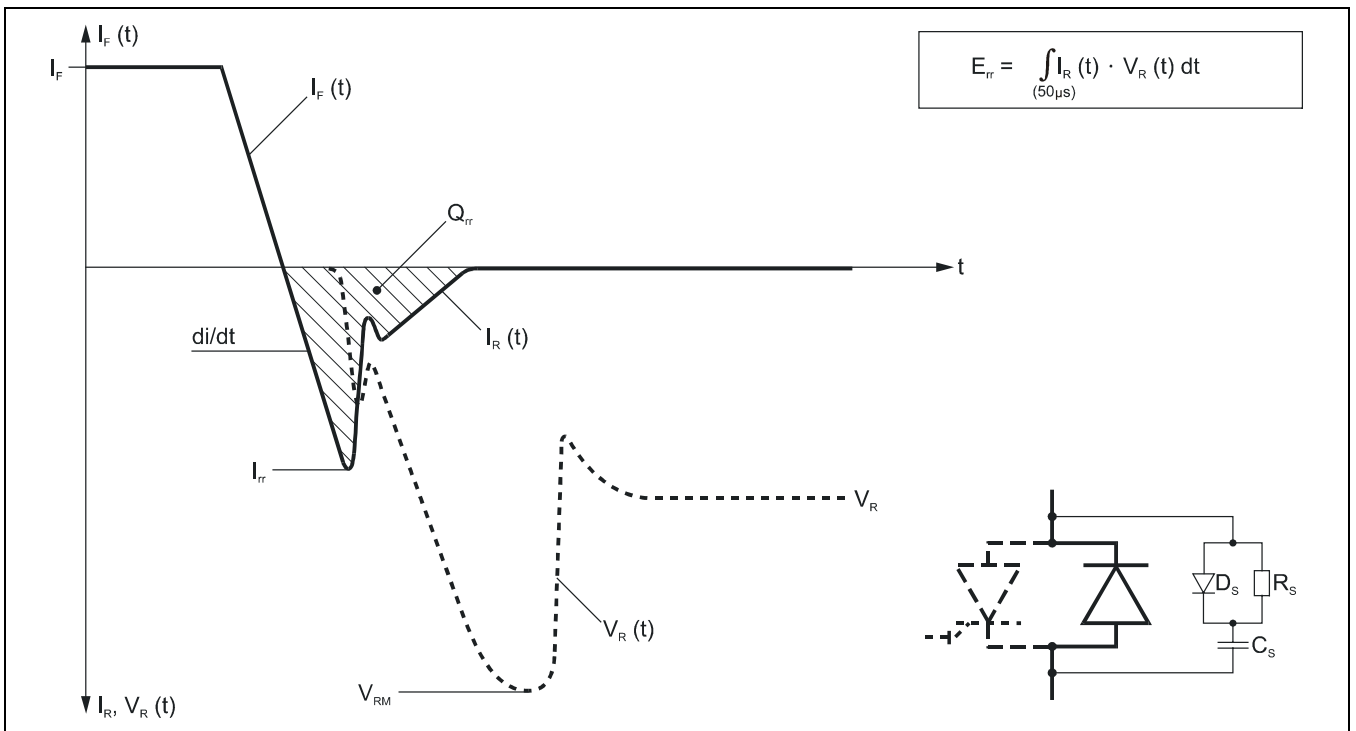

Fig. 6 Typical current and voltage waveforms at turn-off when the diode is connected to an RCD snubber, as often used in GTO circuits.

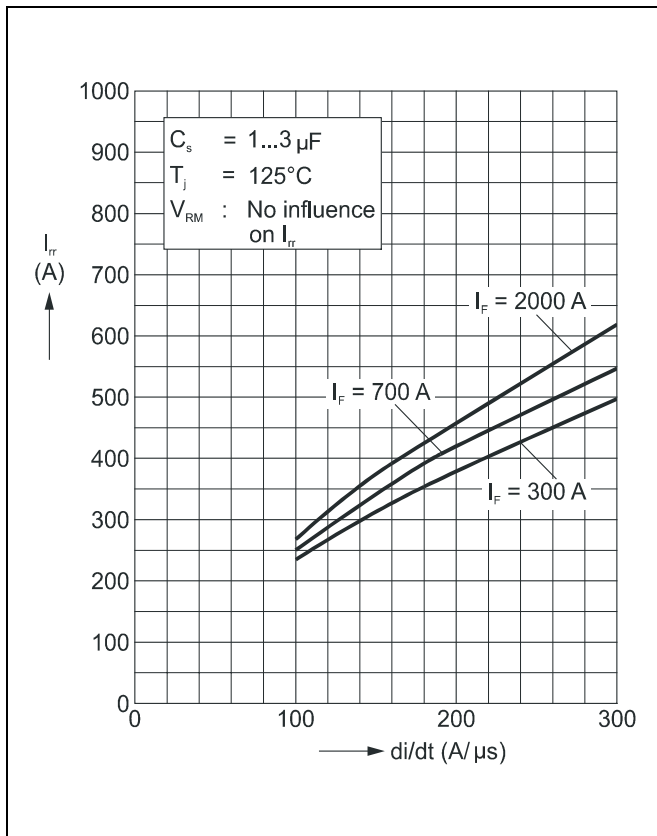

Fig. 7 Reverse recovery current vs. turn off di/dt (max. values).

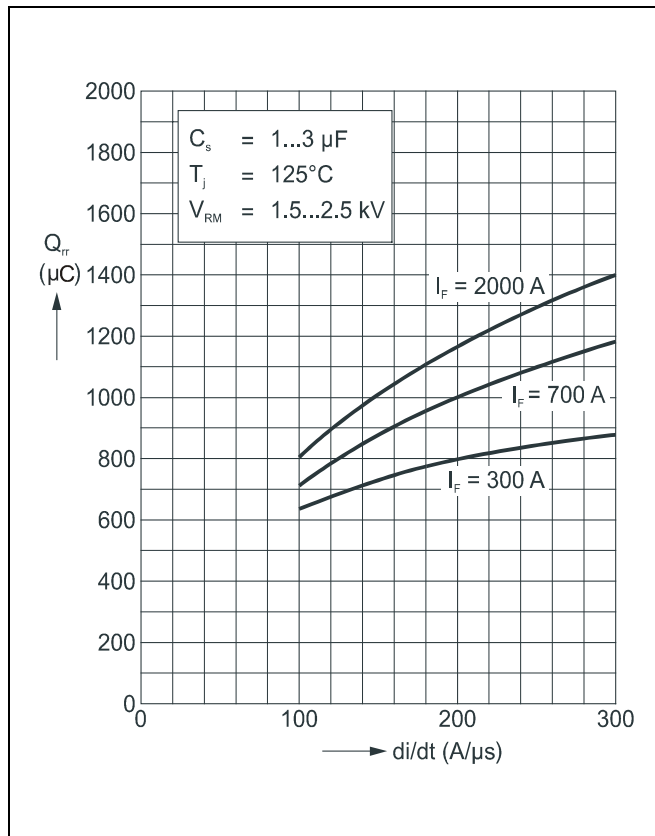

Fig. 8 Reverse recovery charge vs. turn off di/dt (max. values).

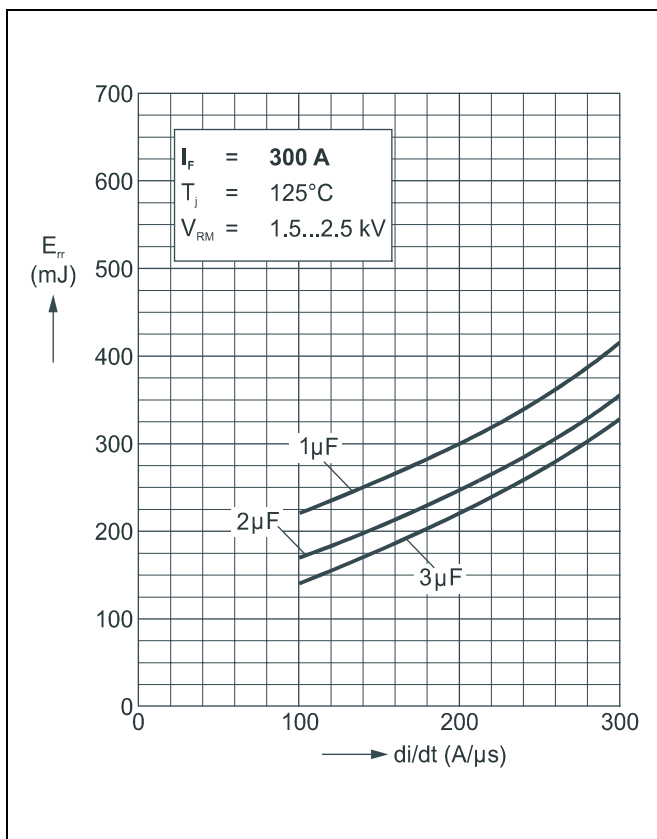

Fig. 9 Turn-off energy vs. turn-off di/dt for $I_F = 300$ A (max. values).

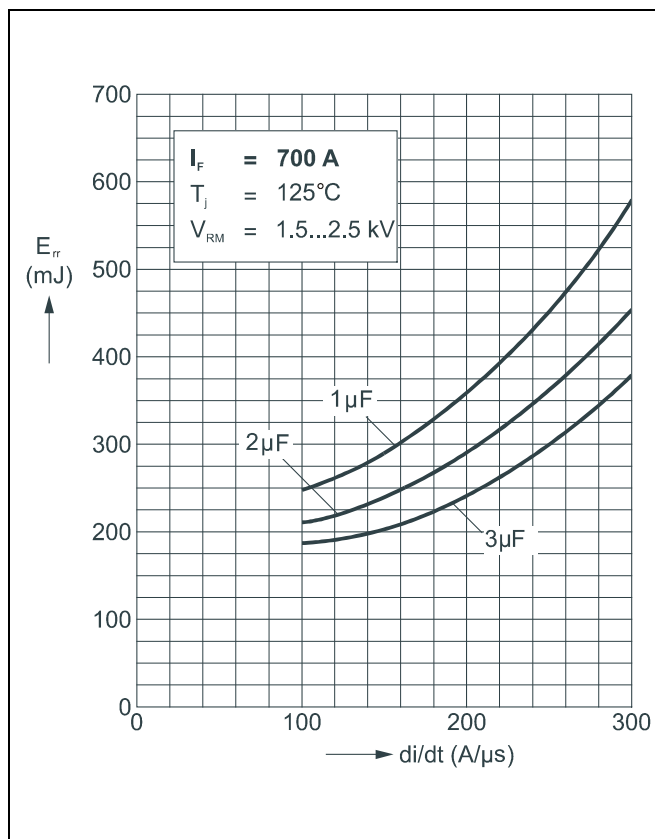

Fig. 10 Turn-off energy vs. turn-off di/dt for $I_F = 700$ A (max. values).

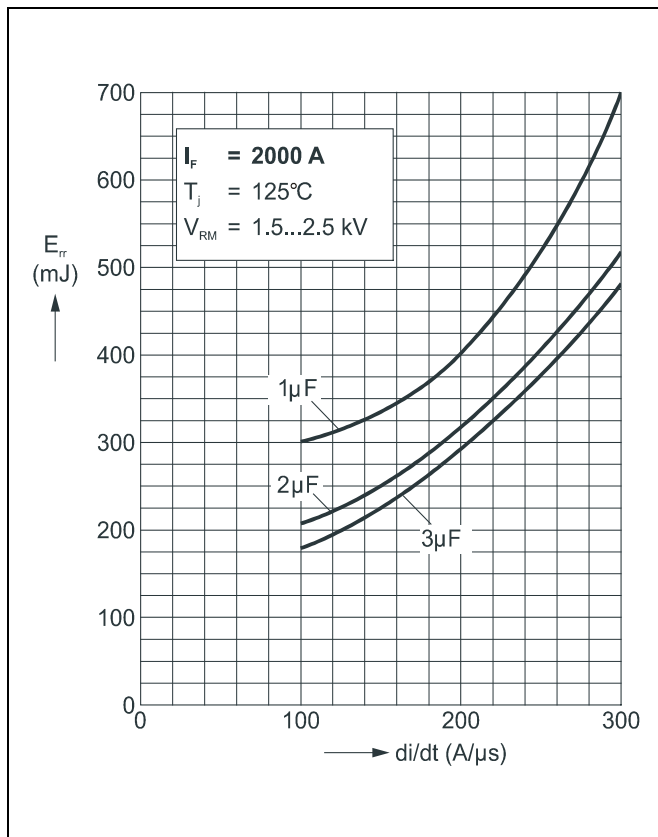

Fig. 11 Turn-off energy vs. turn-off di/dt for $I_F = 2000$ A (max. values).

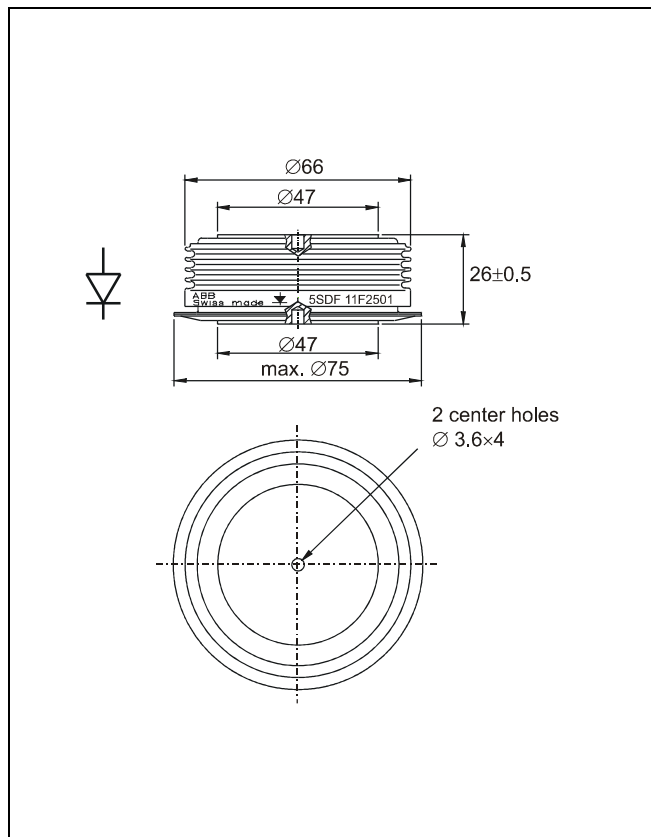

Fig. 12 Outline drawing. All dimensions are in millimeters and represent nominal values unless stated otherwise.

ABB Semiconductors AG reserves the right to change specifications without notice.

ABB

ABB Semiconductors AG
 Fabrikstrasse 3
 CH-5600 Lenzburg, Switzerland

Telephone +41 (0)62 888 6419
 Fax +41 (0)62 888 6306
 Email abbsem@ch.abb.com
 Internet www.abbsem.com