



5.0 mm DIA LED LAMP

560JY8C

REV:A / 0

PACKAGE DIMENSIONS

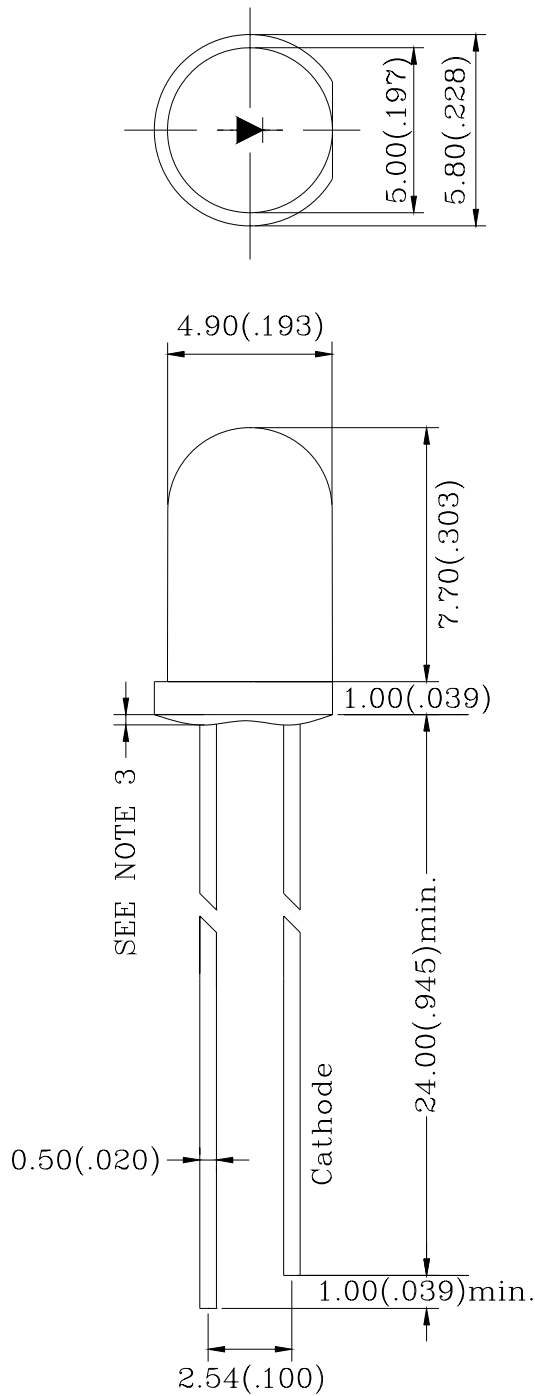

Note:

- 1.All Dimensions are in millimeters.
- 2.Tolerance is $\pm 0.25\text{mm}$ (0.010 ") Unless otherwise specified.
- 3.Protruded resin under flange is 1.5mm(0.059 ") max.
- 4.Lead spacing is measured where the leads emerge from the package.
- 5.Specification are subject to change without notice



5.0 mm DIA LED LAMP

560JY8C

REV:A / 0

FEATURES

- * 5.0mm DIA LED LAMP
- * HIGH LUMINOUS INTENSITY OUTPUT.
- * LOW POWER CONSUMPTION.
- * HIGH EFFICIENCY.
- * VERSATILE MOUNTING ON P.C. BOARD OR PANEL.
- * I.C. COMPATIBLE.

CHIP MATERIALS

- * Dice Material : AlGaInP/GaAs
- * Light Color : ULTRA YELLOW
- * Lens Color : WATER CLEAR

ABSOLUTE MAXIMUM RATING : (Ta = 25°C)

SYMBOL	PARAMETER	ULTRA YELLOW	UNIT
PAD	Power Dissipation Per Chip	80	mW
VR	Reverse Voltage Per Chip	5	V
IAF	Continuous Forward Current Per Chip	30	mA
IPF	Peak Forward Current Per Chip (Duty – 0.1, 1KHz)	80	mA
—	Derating Linear From 25°C Per Chip	0.40	mA/°C
Topr	Operating Temperature Range	-25°C to 85°C	
Tstg	Storage Temperature Range	-40°C to 85°C	
Lead Soldering Temperature { 1.6mm(0.063 inch) From Body } 260°C ± 5°C for 5 Seconds			

ELECTRO-OPTICAL CHARACTERISTICS : (Ta = 25°C)

SYMBOL	PARAMETER	TEST CONDITION	MIN.	TYP.	MAX.	UNIT
VF	Forward Voltage	IF = 20mA	1.8	2.1	2.6	V
IR	Reverse Current	VR = 5V			100	µA
λD	Dominant Wavelength	IF = 20mA	585	588	590	nm
Δλ	Spectral Line Half-Width	IF = 20mA		15		nm
2θ1/2	Half Intensity Angle	IF = 20mA	50	55	60	deg
IV	Luminous Intensity	IF = 20mA	1500	1900	2400	mcd



5.0 mm DIA LED LAMP

560JY8C

REV:A / 0

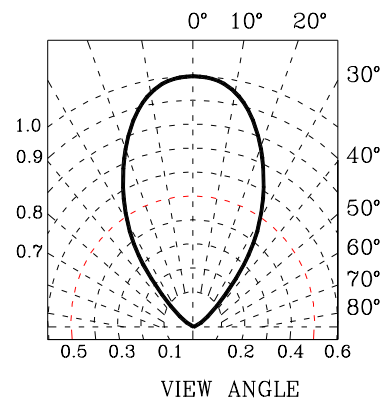
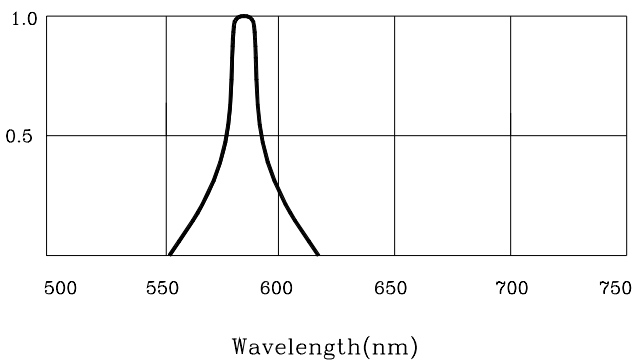
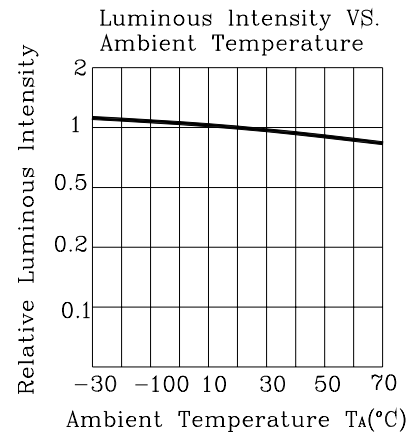
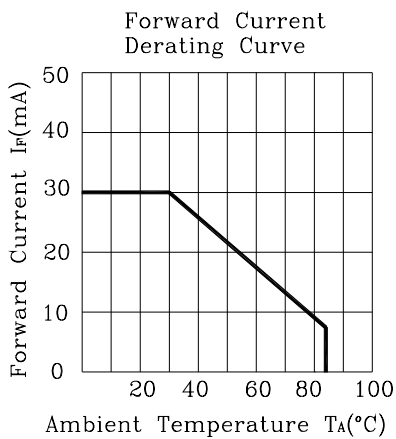
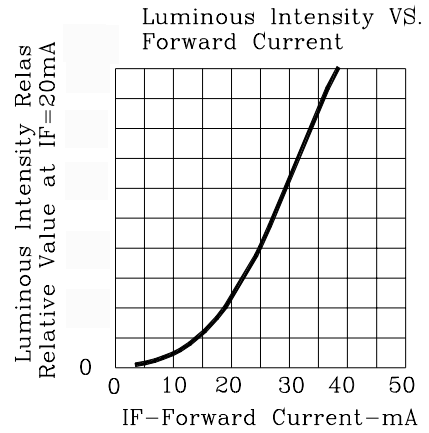
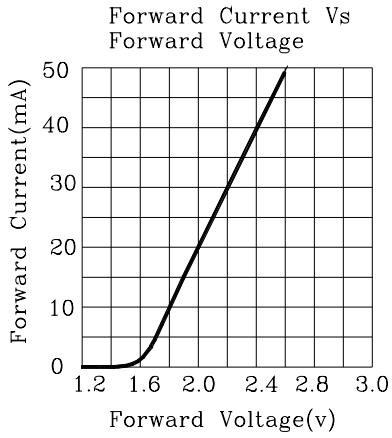



5.0 mm DIA LED LAMP

560JY8C

REV:A / 0

•SOLDERING

METHOD	SOLDERING CONDITIONS	REMARK
DIP SOLDERING	Bath temperature: $260\pm 5^{\circ}\text{C}$ Immersion time: with 5 sec	<ul style="list-style-type: none">• Solder no closer than 3mm from the base of the package• Using soldering flux, "RESIN FLUX" is recommended.
SOLDERING IRON	Soldering iron: 30W or smaller Temperature at tip of iron: 260°C or lower Soldering time: within 5 sec.	<ul style="list-style-type: none">• During soldering, take care not to press the tip of iron against the lead. (To prevent heat from being transferred directly to the lead, hold the lead with a pair of tweezers while soldering

1) When soldering the lead of LED in a condition that the package is fixed with a panel (See Fig.1), be careful not to stress the leads with iron tip.

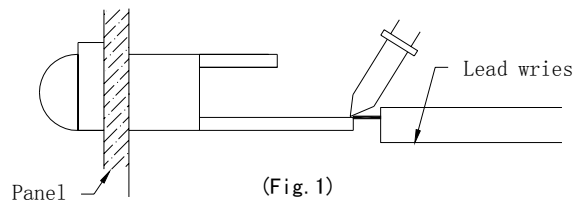

2) When soldering wire to the lead, work with a Fig (See Fig.2) to avoid stressing the package.

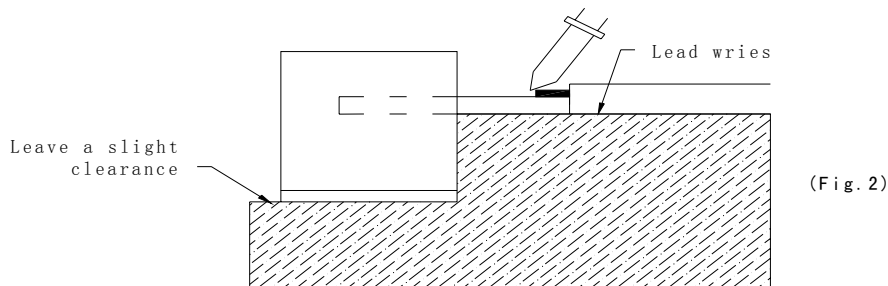



5.0 mm DIA LED LAMP

560JY8C

REV:A / 0

- 3) Similarly, when a jig is used to solder the LED to PC board, take care as much as possible to avoid steering the leads (See Fig.3).

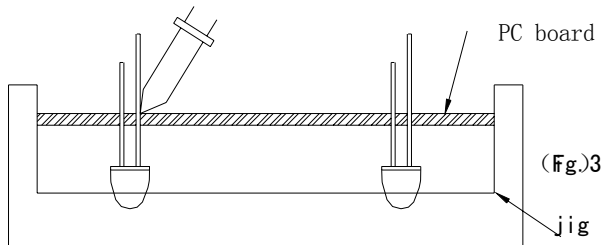

- 4) Repositioning after soldering should be avoided as much as possible. If inevitable, be sure to preserve the soldering conditions with irons stated above: select a best-suited method that assures the least stress to the LED.
- 5) Lead cutting after soldering should be performed only after the LED temperature has returned to normal temperature.

•LED MOUNTING METHOD

- 1) When mounting the LED by using a case, as shown Fig.4, ensure that the mounting holds on the PC board match the pitch of the leads correctly-tolerance of dimensions of the respective components including the LED should be taken into account especially when designing the case, PC board, etc. to prevent pitch misalignment between the leads and board holes, the diameter of the board holes should be slightly larger than the size of the lead. Alternatively, the shape of the holes should be made oval. (See Fig.4)

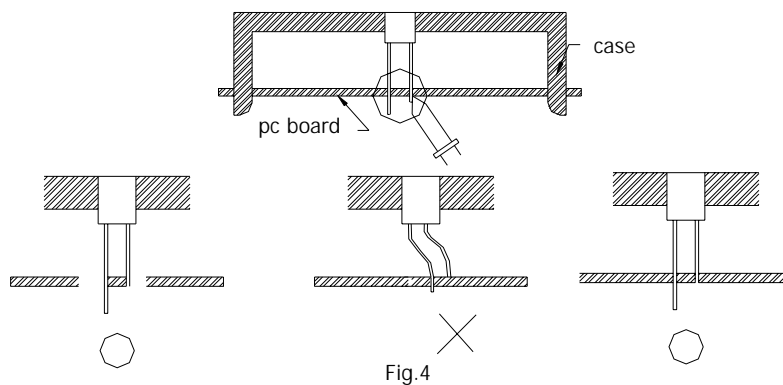



5.0 mm DIA LED LAMP

560JY8C

REV:A / 0

2) Use LEDs with stand-off (Fig.5) or the tube or spacer made of resin (Fig.6) to position the LEDs.

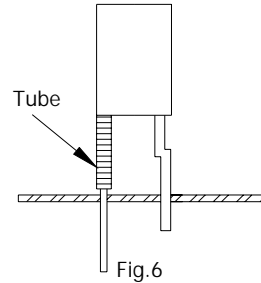
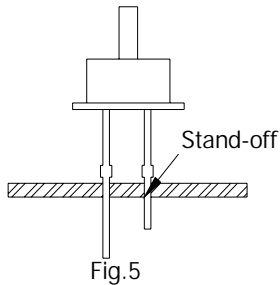

•FORMED LEAD

1) The lead should be bent at a point located at least 2mm away from the package. Bending should be performed with base fixed means of a jig or pliers (Fig.7)

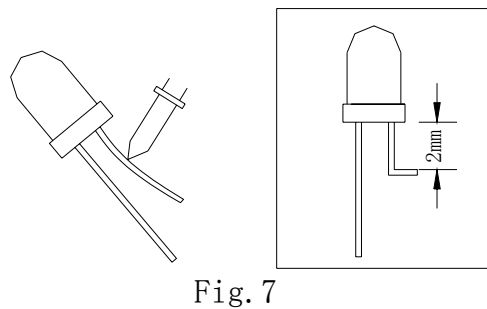

2) Forming lead should be carried out prior to soldering and never during or after soldering.

3) Form the lead to ensure alignment between the leads and the hole on board, so that stress against the LED is prevented. (Fig.8)

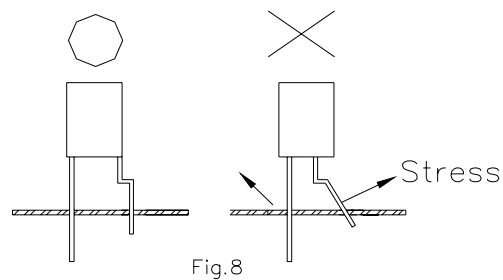



5.0 mm DIA LED LAMP

560JY8C

REV:A / 0

•LEAD STRENGTH

1) Bend strength

Do not bend the lead more than twice. (Fig.9)

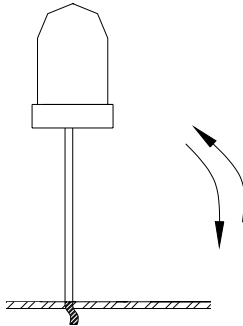

Fig.9

2) Tensile strength (@Room Temperature)

If the force is 1kg or less, there will be no problem. (Fig.10)

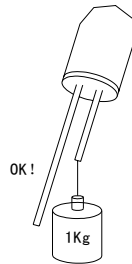

Fig.10

•HANDLING PRECAUTIONS

Although rigid against vibration, the LEDs may be damaged or scratched if dropped. So take care when handling.

•CHEMICAL RESISTANCE

- 1) Avoid exposure to chemicals as it may attack the LED surface and cause discoloration.
- 2) When washing is required, refer to the following table for the proper chemical to be used. (Immersion time: within 3 minutes at room temperature.)

SOLVENT	ADAPTABILITY
Freon TE	⊙
Chloroethene	×
Isopropyl Alcohol	⊙
Thinner	×
Acetone	×
Trichloroethylene	×

⊙--Usable ×--Do not use.

NOTE: Influences of ultrasonic cleaning of the LED resin body differ depending on such factors as the oscillator output, size of the PC board and the way in which the LED is mounted. Therefore, ultrasonic cleaning should only be performed after confirming there is no problem by conducting a test under practical.



5.0 mm DIA LED LAMP

560JY8C

SSREV:A / 0

Experiment Item:

Item	Test Condition	Reference Standard
	Lamp & IR	
OPERATION LIFE	Ta : 25±5°C IF= 20mA RH : ≤60%RH ① DYNAMIC:100mA 1ms 1/10 duty ② STATIC STATE: IF=20mA TEST TIME: 168HRS (-24HRS , +24HRS) 500HRS (-24HRS , +24HRS) 1000HRS (-24HRS , +72HRS)	MIL-STD-750 : 1026 MIL-STD-883 : 1005 JIS C 7021 : B-1
HIGH TEMPERATURE HIGH HUMIDITY STORAGE	Ta : 65°C±5°C RH : 90~95%RH TEST TIME : 240HRS±2HRS	MIL-STD-202 : 103B JIS C 7021 : B-1
TEMPERATURE CYCLING	105°C~25°C~-55°C~25°C 30min 5min 30min 5min 10CYCLES	MIL-STD-202 : 107D MIL-STD-750 : 1051 MIL-STD-883 : 1010 JIS C 7021 : A-4
THERMAL SHOCK	105°C±5°C~-55°C±5°C 10min 10min 10CYCLES	MIL-STD-202 : 107D MIL-STD-750 : 1051 MIL-SYD-883 : 1011
SOLDER RESISTANCE	T , sol : 260°C±5°C DWELL TIME : 10±1sec	MIL-STD-202 : 210A MIL-STD-750-2031 JIS C 7021 : A-1
SOLDERABILITY	T , sol : 230°C±5°C DWELL TIME : 5±1sec	MIL-STD-202 : 208D MIL-STD-750 : 2026 MIL-STD-883 : 2003 JIS C 7021 : A-2