

DATE : 2003. 04. 14.

---

# SPECIFICATION

**PRODUCT : REMOCON MODULE**

---

**MODEL : 451VF4A**

---

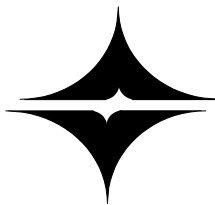

**OPTO ELECTRONICS CO., LTD.**

1066-12 YOUNJANG-RI, JINAN-UP, JINAN-GUN

JEON-BUK, KOREA.

TEL : (063) 433-4566~8

FAX : (063) 433-4569

E-MAIL : [poweroec@hitel.net](mailto:poweroec@hitel.net)

OPTO ELECTRONICS CO., LTD. (株) 元光電子	<b>T I T L E</b> <b>REMOCON PREAMP</b> <b>451VF4A</b>	문서 번호	OQSS-R-164
		개정 번호	IR
		개정 일자	2003년 4월 14일
		P A G E	1 / 6

### 1. GENERAL DESCRIPTION

The 451VF4A is miniaturized receiver for infrared remote control systems. PIN photo diode and preamplifier are assembled on lead frame, the epoxy package is designed as IR filter.

### 2. Application

AV equipment such as TV sets, VCRs and audio equipment.  
HA equipment such as air conditioners and electric fans.

### 3. Outline

Refer to the attached drawing 451VF4A

### 4. Features

- \* Photo detector and preamplifier in one package
- \* Enhanced immunity against all kinds of disturbance light
- \* High performance photo diode and built-in excursive I · C
- \* High speed response and output
- \* Low consumption of electric power and easy use

### 5. Block Diagram

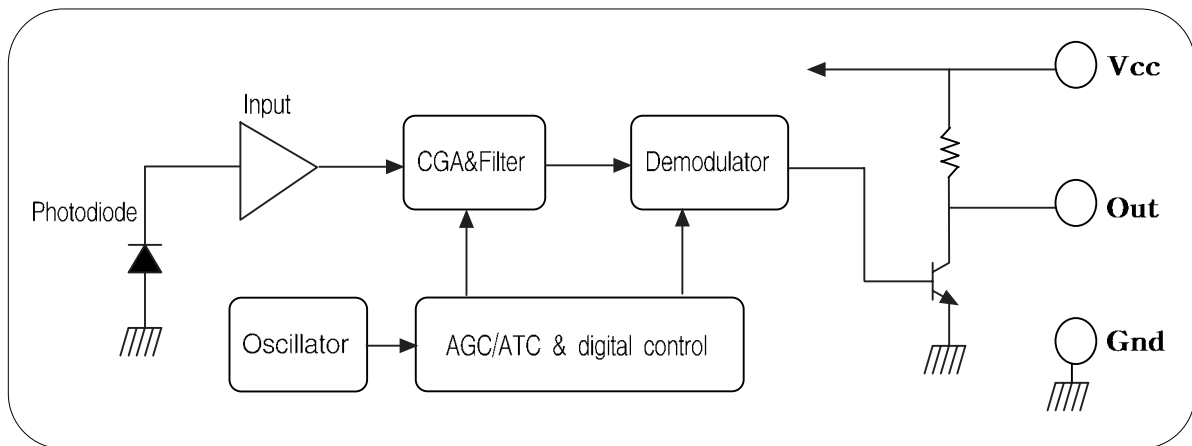

### NOTE

OPTO ELECTRONICS CO., LTD. (株) 元光電子	T I T L E REMOCON PREAMP 451VF4A	문서 번호	OQSS-R-164
		개정 번호	IR
		개정 일자	2003년 4월 14일
		PAGE	2 / 6

6. Ratings and Characteristics

6-1. Absolute maximum ratings

(Ta=25°C)

Characteristics	Symbol	Value	Unit
Power supply voltage	Vcc	6.0	V
Operating temperature	Topr	-10 to +60	°C
Storage temperature	Tstg	-20 to +75	°C
Soldering temperature	Tsol	260 , 5 sec	°C

6-2. Electro-optical characteristics

\* All values are at 25°C

(Ta=25°C)

Characteristic	Symbol	Condition	Min	Typ	Max	Unit	
Supply voltage	Vcc		4.5	5.0	5.5	V	
Current consumption	Icc	*1	0.3	-	2.0	mA	
Resonance frequency	Fo		-	38	-	KHz	
Peak wave length	$\lambda p$		-	980	-	nm	
H level output voltage	Voh	*2	4.5	5.0	-	V	
L level output voltage	Vol	*2	-	0.2	0.4	V	
H level pulse width	Twh	*2	500	-	700	us	
L level pulse width	Twl		500	-	700	us	
Arrival distance	L	*2,3,4	$\pm 0^\circ$	-	20	-	m
			$\pm 30^\circ$	-	10	-	
			$\pm 45^\circ$	-	8	-	
Output form	Active low						

◆ 1. No input signal, Vin=0V

◆ 2. The specifications 6-2 shall be satisfied under the following conditions

2-1. The burst wave forms shown bellow in the Fig 1 shall be transmitted by the standard transmitter.

The standard transmitter shall be specified of the burst wave form in the Fig 1 adjusted to Vout 200mVp-p upon Po measuring circuit Fig 2.

NOTE

OPTO ELECTRONICS CO., LTD. (株) 元光電子	<b>T I T L E</b> <b>REMOCON PREAMP</b> <b>451VF4A</b>	문서 번호	OQSS-R-164
		개정 번호	IR
		개정 일자	2003년 4월 14일
		P A G E	3 / 6

Fig 1. Output Waveform

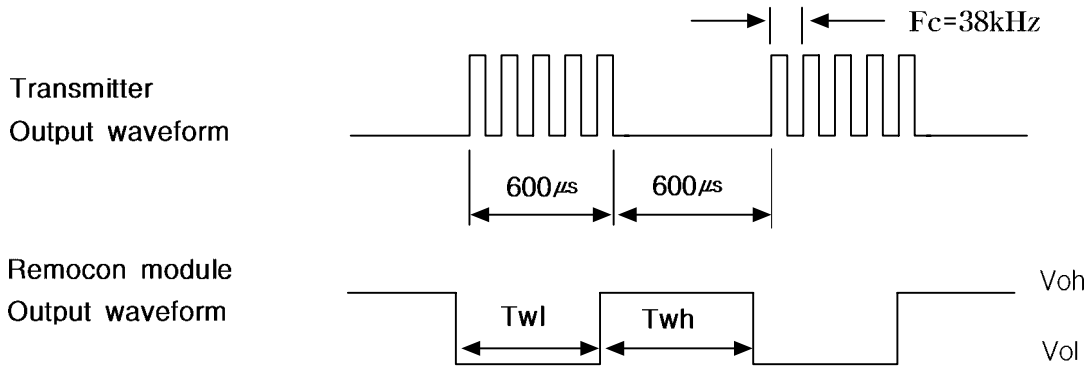
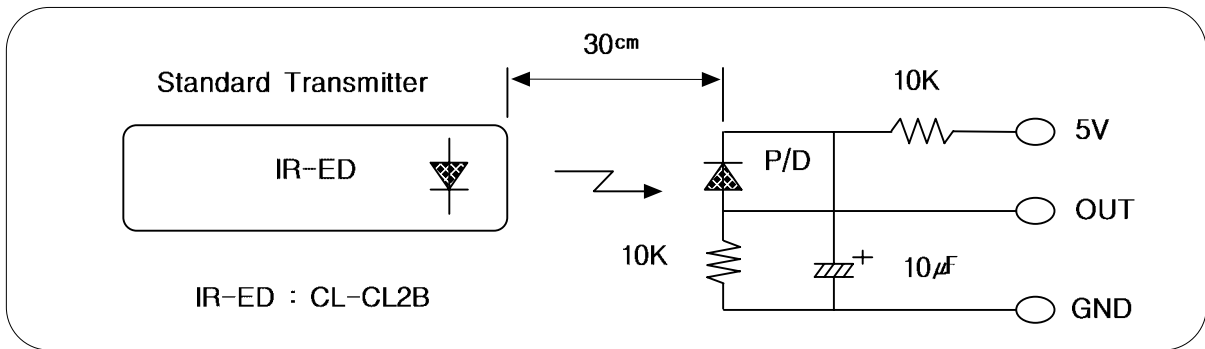
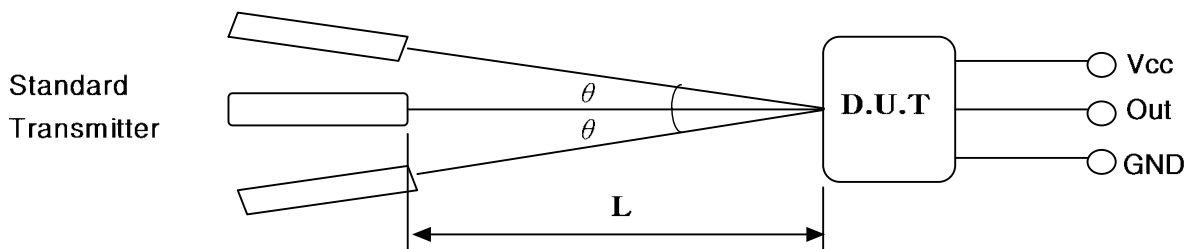

Fig 2. Po Measuring circuit



◆ 3. Arrival distance test condition



Where  $\theta$  : Horizontal and vertical directions

D.U.T : Device under test

◆ 4. The arrival distance is measured in the darkness without disturbing noises.

NOTE

7. Reliability

Test items	Test conditions	Remarks
High temp high humid	Ta=40°C 90%RH t=96H	* 1, 2
Heat cycle	* 2, 3	
Fall test	* 4	

- \* 1. Supply voltage 5V in the load test.
- \* 2. Electro-optical chara. (6-2) shall satisfy the figure they be left 2H at normal condition.
- \* 3. Heat cycle test as below Fig 3 for 20 cycles under no load.

Fig 3. heat cycle

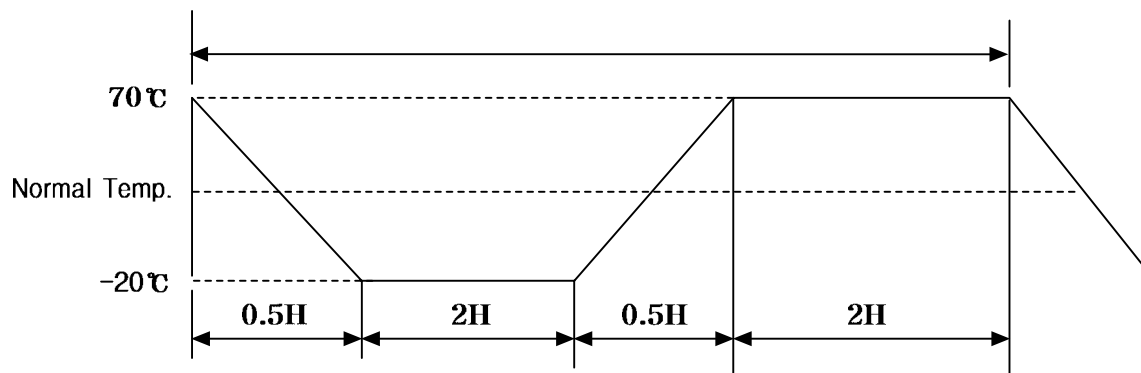

- ◆ 4. Fall test  
 The test devices to fall three time onto hard wooden board from a level 75Cm

NOTE	
------	--

OPTO ELECTRONICS CO., LTD. (株) 元光電子	<b>T I T L E</b> <b>REMOCON PREAMP</b> <b>451VF4A</b>	문서 번호	OQSS-R-164
		개정 번호	IR
		개정 일자	2003년 4월 14일
		P A G E	5 / 6

8. The Others

In case of noisy power supply, please serially insert about 47ohm resistance and about 47uF Electrolytic capacitance in Vcc line as follows.

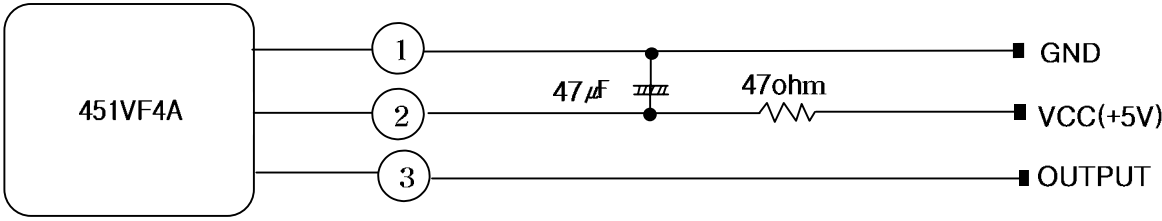

9. Precaution in handling

When soldering leave 2mm of minimum clearance between the resin and the soldering point.

NOTE	
------	--

OPTO

ELECTRONICS CO., LTD.

(株) 元光電子

T I T L E  
REMOCON PREAMP  
451VF4A

문서 번호

OQSS-R-164

개정 번호

IR

개정 일자

2003년 4월 14일

P A G E

6 / 6

■ Typical Characteristics (Tamb = 25°C unless otherwise specified)

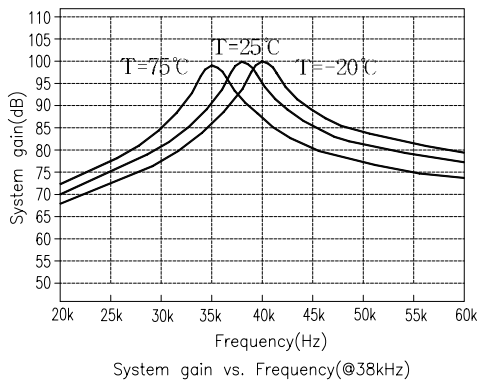
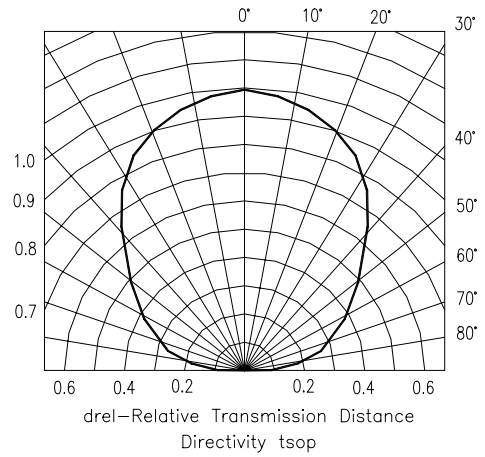
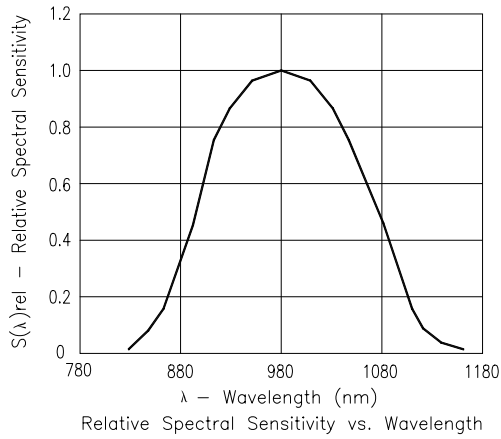

NOTE

OPTO ELECTRONICS CO., LTD. (株) 元光電子	<b>T I T L E</b> <b>REMOCON PREAMP</b> <b>451VF4A</b>	문서번호	QQSS-R-164
		개정번호	IR
		개정일자	2003년 4월 14일
		PAGE	

※ 포장 방법 ※

1. 외부 포장

외부 포장은 골판지를 이용하여 제품의 수량 및 무게에 따라 선택 포장한다.  
포장후 상자의 운반중 내용물이 움직여 손상될 가능성이 있다고 판단되는 경우에는 별도의 완충제를 사용하여 움직임이 없도록 하며 이때 완충제의 사용은 최소량으로 한다.  
그리고 상자의 바깥날개 봉합은 접착 테이프를 사용한다.

2. 포장 표시사항

포장 완료후에는 각제품의 도면에 지정된 표시사항에 따라 외부 포장상자에 인쇄나 유성 INK 또는 지워지지 않는 방법으로 아래의 내용을 표기한다.

- 1) 제품명
- 2) MODEL명
- 3) 수량
- 4) 제조사명
- 5) 취급주의 표시사항

3. 포장 BOX SIZE 및 수량

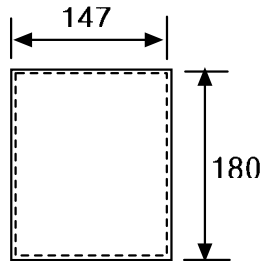

PACKING POLY BAG (ANTISTATIC)  
수량 : 100EA

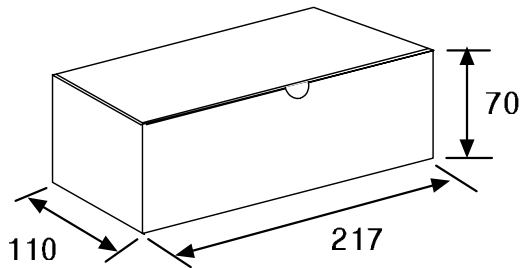

PACKING IN BOX (IB-70)  
수량 : 600EA(100×6)

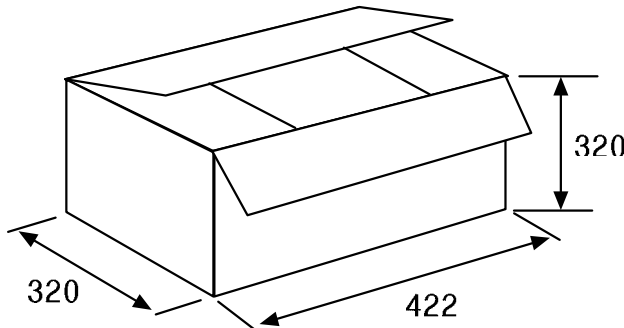

PACKING OUTBOX(OB-57)  
수량 : 10,200EA(600×17)

NOTE



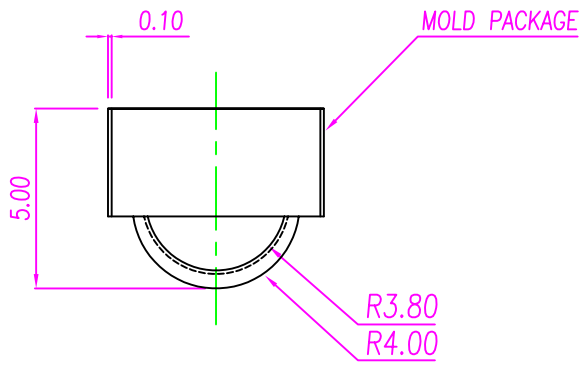

# NOTE

GENERAL TOLERANCE :  $\pm 0.2$

1. GND
2. Vcc
3. OUTPUT

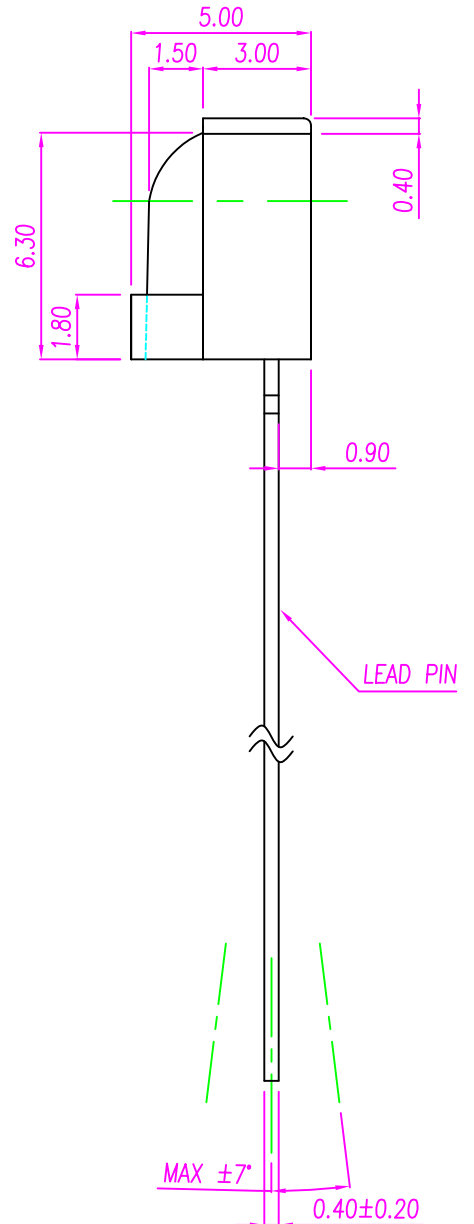
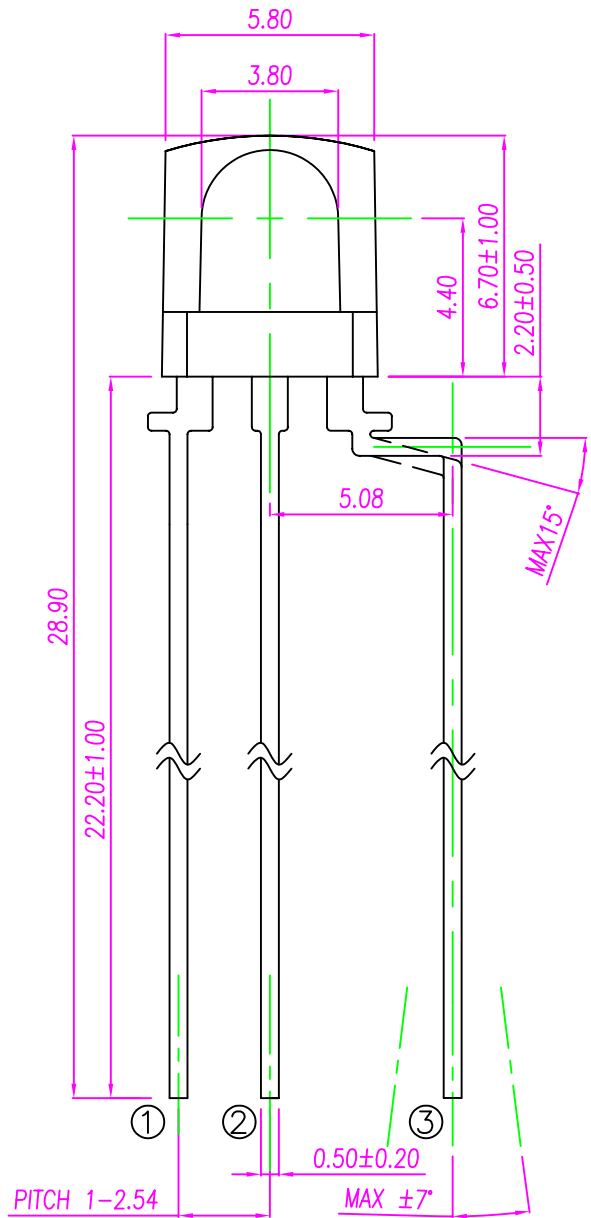

DATE	2003.04.21.	UNLESS OTHERWISE SPECIFIED DIMENSIONS ARE IN MILLIMETERS AND TOLERANCES ARE AS FOLLOWS: <table border="1"> <tr><td>0 - 6</td><td>±0.1</td></tr> <tr><td>6 - 15</td><td>±0.15</td></tr> <tr><td>15 - 60</td><td>±0.2</td></tr> <tr><td>60 - 200</td><td>±0.3</td></tr> <tr><td>200 - ∞</td><td>±0.5</td></tr> </table>	0 - 6	±0.1	6 - 15	±0.15	15 - 60	±0.2	60 - 200	±0.3	200 - ∞	±0.5	TITLE	451VF4A
0 - 6	±0.1													
6 - 15	±0.15													
15 - 60	±0.2													
60 - 200	±0.3													
200 - ∞	±0.5													
UNIT	mm													
SCALE	5/1													
MATERIAL														



OPTO ELECTRONICS CO.,LTD

D.W.G NO.

OR10-164-A