

#### Features

- UltraFast Non Punch Through (NPT) Technology
- Positive  $V_{CE(ON)}$  Temperature Coefficient
- 10 $\mu$ s Short Circuit Capability
- HEXFRED™ Antiparallel Diodes with UltraSoft Reverse Recovery
- Low Diode  $V_F$
- Square RBSOA
- Aluminum Nitride DBC
- Optional SMT Thermistor (NTC)
- Very Low Stray Inductance Design for High Speed Operation
- UL approved (file E78996)

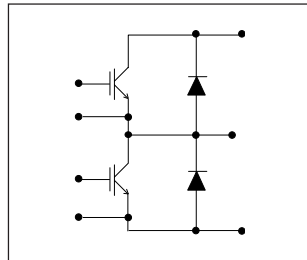

$$V_{CES} = 1200V$$

$$I_C = 80A$$

$$T_C = 25^\circ C$$

#### Benefits

- Optimized for Welding, UPS and SMPS Applications
- Rugged with UltraFast Performance
- Benchmark Efficiency above 20KHz
- Outstanding ZVS and Hard Switching Operation
- Low EMI, requires Less Snubbing
- Excellent Current Sharing in Parallel Operation
- Direct Mounting to Heatsink
- PCB Solderable Terminals

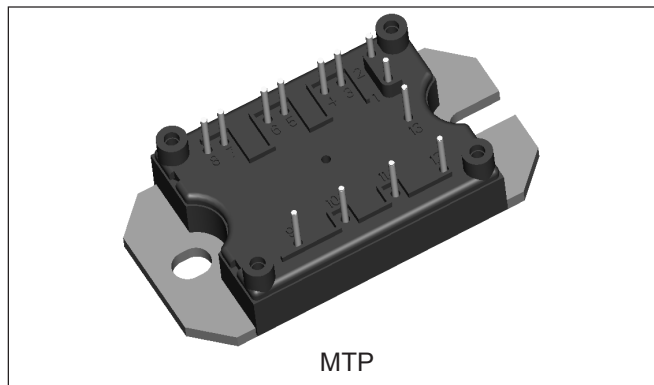

#### Absolute Maximum Ratings

Parameters		Max	Units
$V_{CES}$	Collector-to-Emitter Breakdown Voltage	1200	V
$I_C$	Continuos Collector Current	@ $T_C = 25^\circ C$	80
		@ $T_C = 105^\circ C$	40
$I_{CM}$	Pulsed Collector Current	160	
$I_{LM}$	Clamped Inductive Load Current	160	
$I_F$	Diode Continuous Forward Current	21	@ $T_C = 105^\circ C$
$I_{FM}$	Diode Maximum Forward Current	160	
$V_{GE}$	Gate-to-Emitter Voltage	$\pm 20$	V
$V_{ISOL}$	RMS Isolation Voltage, Any Terminal to Case, $t = 1$ min	2500	
$P_D$	Maximum Power Dissipation (only IGBT)	@ $T_C = 25^\circ C$	463
		@ $T_C = 100^\circ C$	185

**Electrical Characteristics @ T<sub>J</sub> = 25°C (unless otherwise specified)**

Parameters	Min	Typ	Max	Units	Test Conditions
V <sub>(BR)CES</sub> Collector-to-Emitter Breakdown Voltage	1200			V	V <sub>GE</sub> = 0V, I <sub>C</sub> = 250μA
ΔV <sub>(BR)CES</sub> /ΔT <sub>J</sub> Temperature Coeff. of Breakdown Voltage		+1.1		V/°C	V <sub>GE</sub> = 0V, I <sub>C</sub> = 3mA (25-125°C)
V <sub>CE(ON)</sub> Collector-to-Emitter Saturation Voltage		3.36	3.59	V	V <sub>GE</sub> = 15V, I <sub>C</sub> = 40A
		4.53	4.91		V <sub>GE</sub> = 15V, I <sub>C</sub> = 80A
		3.88	4.10		V <sub>GE</sub> = 15V, I <sub>C</sub> = 40A T <sub>J</sub> = 150°C
		5.35	5.68		V <sub>GE</sub> = 15V, I <sub>C</sub> = 80A T <sub>J</sub> = 150°C
V <sub>GE(th)</sub> Gate Threshold Voltage	4		6	V	V <sub>CE</sub> = V <sub>GE</sub> , I <sub>C</sub> = 500μA
ΔV <sub>GE(th)</sub> /ΔT <sub>J</sub> Temperature Coeff. of Threshold Voltage		-12		mV/°C	V <sub>CE</sub> = V <sub>GE</sub> , I <sub>C</sub> = 1mA (25-125°C)
g <sub>fe</sub> Transconductance		35		S	V <sub>CE</sub> = 50V, I <sub>C</sub> = 40A, PW = 80μs
I <sub>CES</sub> Zero Gate Voltage Collector Current			250	μA	V <sub>GE</sub> = 0V, V <sub>CE</sub> = 1200V, T <sub>J</sub> = 25°C
		0.4	1.0	mA	V <sub>GE</sub> = 0V, V <sub>CE</sub> = 1200V, T <sub>J</sub> = 125°C
		0.2	10		V <sub>GE</sub> = 0V, V <sub>CE</sub> = 1200V, T <sub>J</sub> = 150°C
I <sub>GES</sub> Gate-to-Emitter Leakage Current			±250	nA	V <sub>GE</sub> = ± 20V

**Switching Characteristics @ T<sub>J</sub> = 25°C (unless otherwise specified)**

Parameters	Min	Typ	Max	Units	Test Conditions
Q <sub>g</sub> Total Gate Charge (turn-on)		399	599	nC	I <sub>C</sub> = 40A V <sub>CC</sub> = 600V V <sub>GE</sub> = 15V
Q <sub>ge</sub> Gate-Emitter Charge (turn-on)		43	65		
Q <sub>gc</sub> Gate-Collector Charge (turn-on)		187	281		
E <sub>on</sub> Turn-On Switching Loss		1142	1713	μJ	V <sub>CC</sub> = 600V, I <sub>C</sub> = 40A V <sub>GE</sub> = 15V, R <sub>g</sub> = 5Ω, L = 200μH T <sub>J</sub> = 25°C, Energy losses include tail and diode reverse recovery
E <sub>off</sub> Turn-Off Switching Loss		1345	2018		
E <sub>tot</sub> Total Switching Loss		2487	3731		
E <sub>on</sub> Turn-On Switching Loss		1598	2397	μJ	V <sub>CC</sub> = 600V, I <sub>C</sub> = 40A V <sub>GE</sub> = 15V, R <sub>g</sub> = 5Ω, L = 200μH T <sub>J</sub> = 125°C, Energy losses include tail and diode reverse recovery
E <sub>off</sub> Turn-Off Switching Loss		1618	2427		
E <sub>tot</sub> Total Switching Loss		3216	4824		
C <sub>ies</sub> Input Capacitance		5521	8282	pF	V <sub>GE</sub> = 0V V <sub>CC</sub> = 30V f = 1.0 MHz
C <sub>oes</sub> Output Capacitance		380	570		
C <sub>res</sub> Reverse Transfer Capacitance		171	257		
RBSOA Reverse Bias Safe Operating Area	full square				T <sub>J</sub> = 150°C, I <sub>C</sub> = 160A V <sub>CC</sub> = 1000V, V <sub>p</sub> = 1200V R <sub>g</sub> = 5Ω, V <sub>GE</sub> = +15V to 0V
SCSOA Short Circuit Safe Operating Area	10			μs	T <sub>J</sub> = 150°C V <sub>CC</sub> = 900V, V <sub>p</sub> = 1200V R <sub>g</sub> = 5Ω, V <sub>GE</sub> = +15V to 0V

### Diode Characteristics @ T<sub>J</sub> = 25°C (unless otherwise specified)

Parameters	Min	Typ	Max	Units	Test Conditions
V <sub>FM</sub> Diode Forward Voltage Drop		2.98	3.38	V	I <sub>C</sub> = 40A
		3.90	4.41		I <sub>C</sub> = 80A
		3.08	3.39		I <sub>C</sub> = 40A, T <sub>J</sub> = 125°C
		4.29	4.72		I <sub>C</sub> = 80A, T <sub>J</sub> = 125°C
		3.12	3.42		I <sub>C</sub> = 40A, T <sub>J</sub> = 150°C
E <sub>rec</sub> Reverse Recovery Energy of the Diode		574	861	μJ	V <sub>GE</sub> = 15V, R <sub>g</sub> = 5Ω, L = 200μH
trr Diode Reverse Recovery Time		120	180	ns	V <sub>CC</sub> = 600V, I <sub>C</sub> = 40A
I <sub>rr</sub> Peak Reverse Recovery Current		43	65	A	T <sub>J</sub> = 125°C

### Thermistor Specifications (40MT120UHT only)

Parameters	Min	Typ	Max	Units	Test Conditions
R <sub>0</sub> <sup>(1)</sup> Resistance		30		kΩ	T <sub>0</sub> = 25°C
β <sup>(1)(2)</sup> Sensitivity index of the thermistor material		4000		K	T <sub>0</sub> = 25°C T <sub>1</sub> = 85°C

<sup>(1)</sup> T<sub>0</sub>, T<sub>1</sub> are thermistor's temperatures

$$\beta = \frac{R_0}{R_1} = \exp \left[ \beta \left( \frac{1}{T_0} - \frac{1}{T_1} \right) \right], \text{ Temperatures in Kelvin}$$

### Thermal- Mechanical Specifications

Parameters	Min	Typ	Max	Units
T <sub>J</sub> Operating Junction Temperature Range	- 40		150	°C
T <sub>STG</sub> Storage Temperature Range	- 40		125	
R <sub>thJC</sub> Junction-to-Case	IGBT		0.20	°C/ W
	Diode		0.39	
R <sub>thCS</sub> Case-to-Sink (Heatsink Compound Thermal Conductivity = 1 W/mK)	Module		0.06	
Clearance (external shortest distance in air between two terminals)	5.5			mm
Creepage (shortest distance along external surface of the insulating material between 2 terminals)	8			
T Mounting torque to heatsink (3)		3 ± 10%		Nm
Wt Weight		66		g (oz)

(3) A mounting compound is recommended and the torque should be checked after 3 hours to allow for the spread of the compound. Lubricated threads

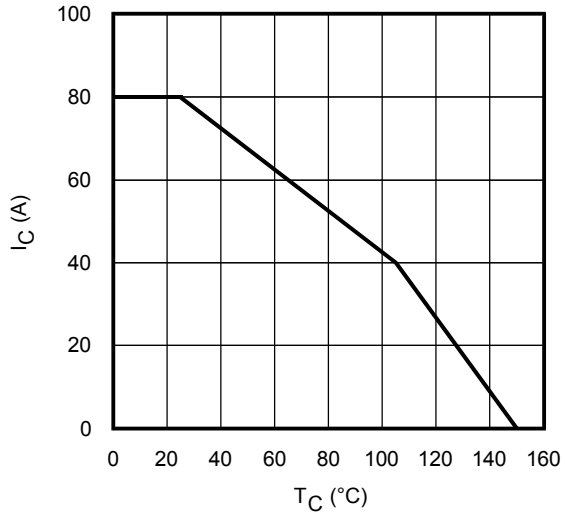

**Fig. 1** - Maximum DC Collector Current vs. Case Temperature

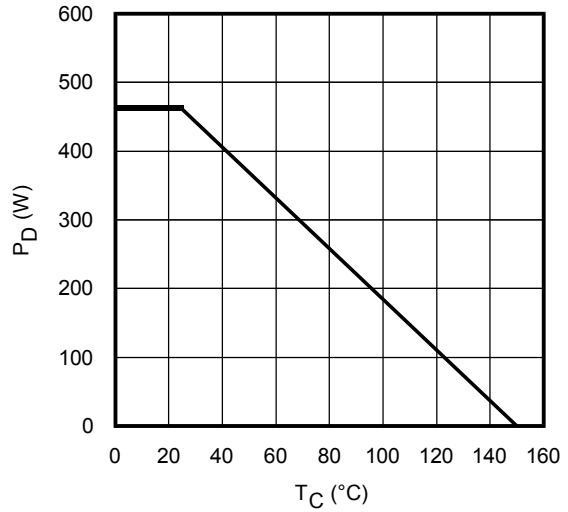

**Fig. 2** - Power Dissipation vs. Case Temperature

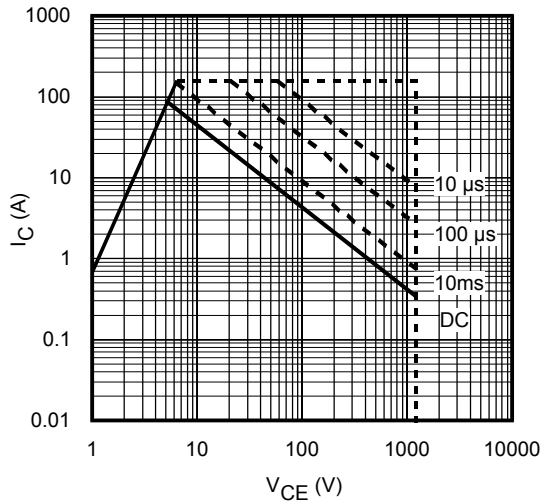

**Fig. 3** - Forward SOA  
 $T_C = 25^\circ\text{C}$ ;  $T_J \leq 150^\circ\text{C}$

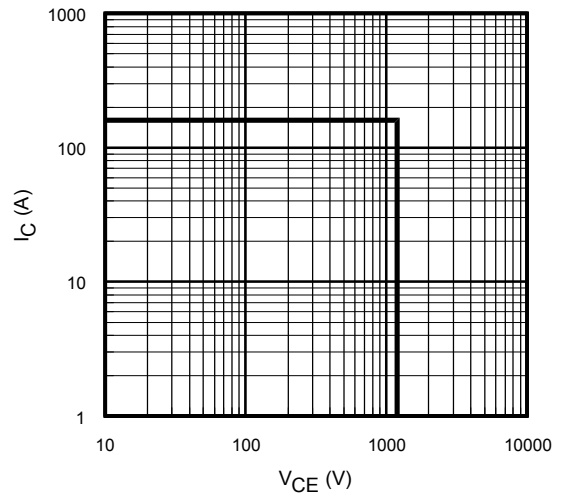

**Fig. 4** - Reverse Bias SOA  
 $T_J = 150^\circ\text{C}$ ;  $V_{GE} = 15\text{V}$

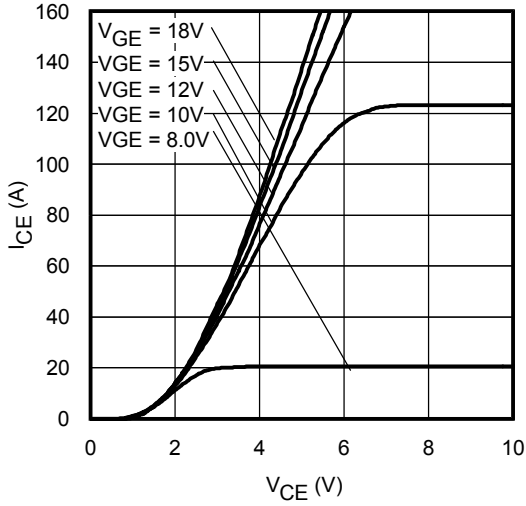

**Fig. 5 - Typ. IGBT Output Characteristics**  
 $T_J = -40^\circ\text{C}; t_p = 80\mu\text{s}$

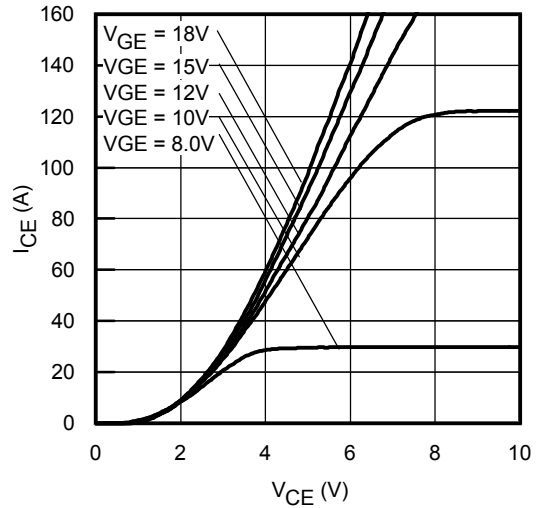

**Fig. 6 - Typ. IGBT Output Characteristics**  
 $T_J = 25^\circ\text{C}; t_p = 80\mu\text{s}$

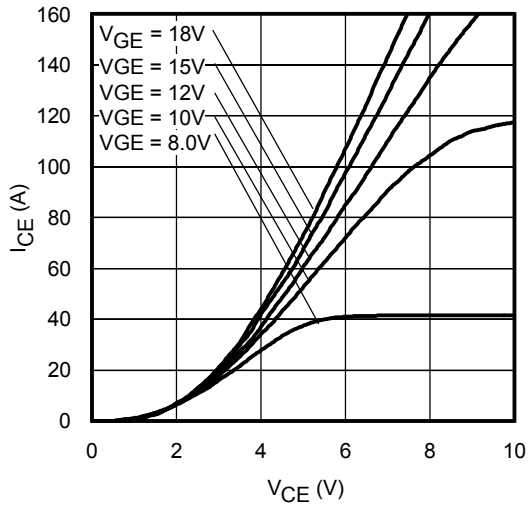

**Fig. 7 - Typ. IGBT Output Characteristics**  
 $T_J = 125^\circ\text{C}; t_p = 80\mu\text{s}$

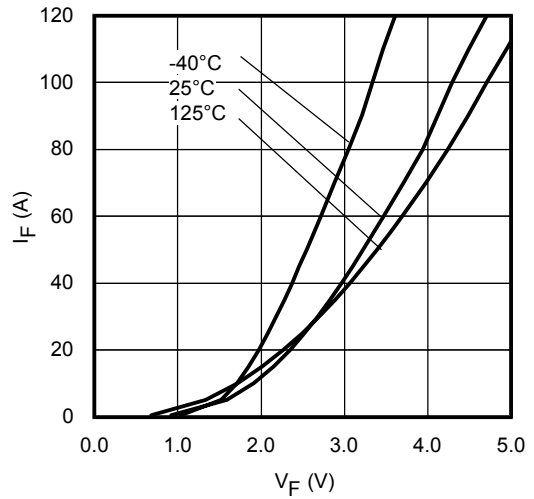

**Fig. 8 - Typ. Diode Forward Characteristics**  
 $t_p = 80\mu\text{s}$

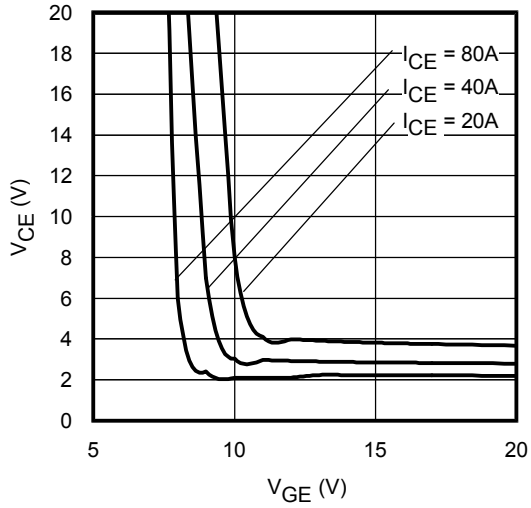

**Fig. 9** - Typical  $V_{CE}$  vs.  $V_{GE}$   
 $T_J = -40^\circ\text{C}$

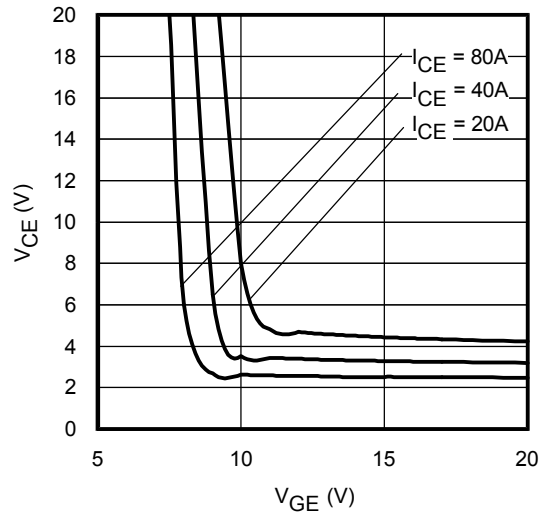

**Fig. 10** - Typical  $V_{CE}$  vs.  $V_{GE}$   
 $T_J = 25^\circ\text{C}$

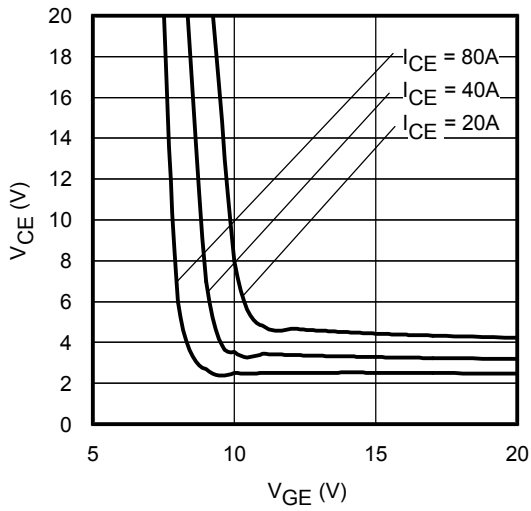

**Fig. 11** - Typical  $V_{CE}$  vs.  $V_{GE}$   
 $T_J = 125^\circ\text{C}$

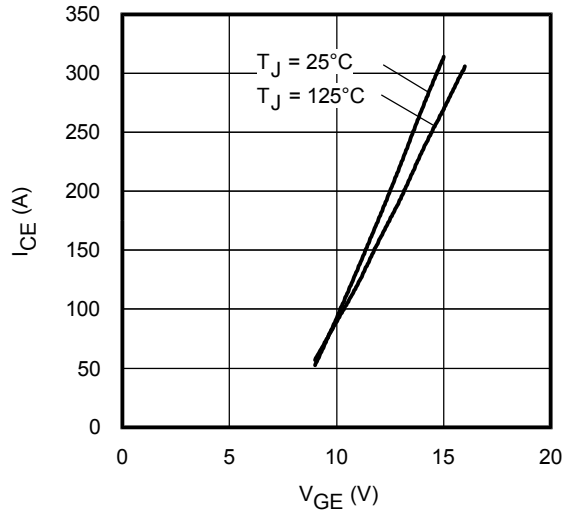

**Fig. 12** - Typ. Transfer Characteristics  
 $V_{CE} = 50\text{V}$ ;  $t_p = 10\mu\text{s}$

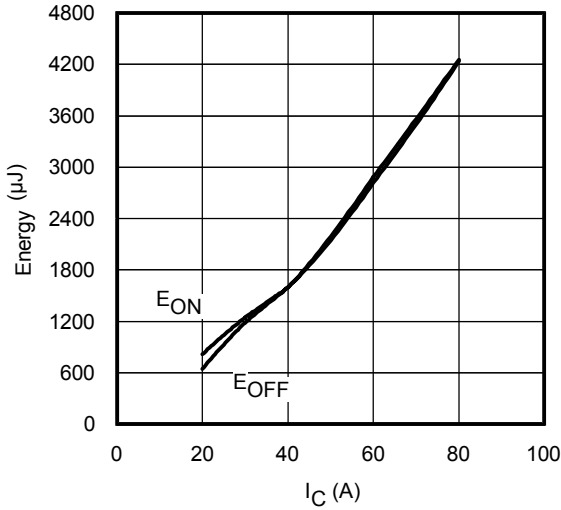

**Fig. 13** - Typ. Energy Loss vs.  $I_C$   
 $T_J = 125^\circ\text{C}$ ;  $L = 250\mu\text{H}$ ;  $V_{CE} = 400\text{V}$   
 $R_G = 5\Omega$ ;  $V_{GE} = 15\text{V}$

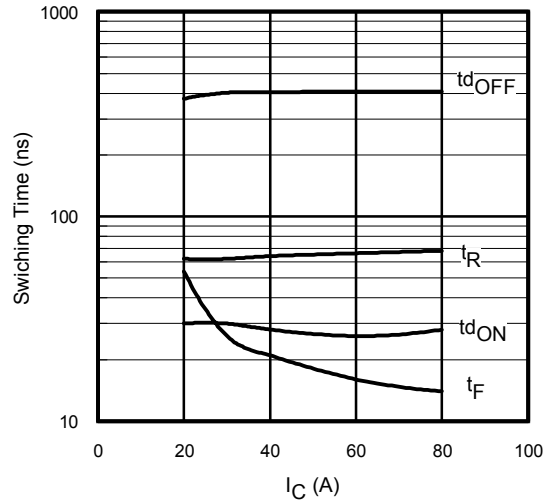

**Fig. 14** - Typ. Switching Time vs.  $I_C$   
 $T_J = 125^\circ\text{C}$ ;  $L = 250\mu\text{H}$ ;  $V_{CE} = 400\text{V}$   
 $R_G = 5\Omega$ ;  $V_{GE} = 15\text{V}$

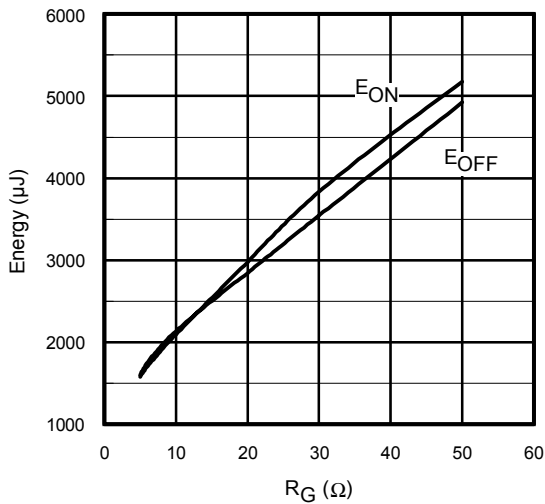

**Fig. 15** - Typ. Energy Loss vs.  $R_G$   
 $T_J = 150^\circ\text{C}$ ;  $L = 250\mu\text{H}$ ;  $V_{CE} = 600\text{V}$   
 $I_{CE} = 40\text{A}$ ;  $V_{GE} = 15\text{V}$

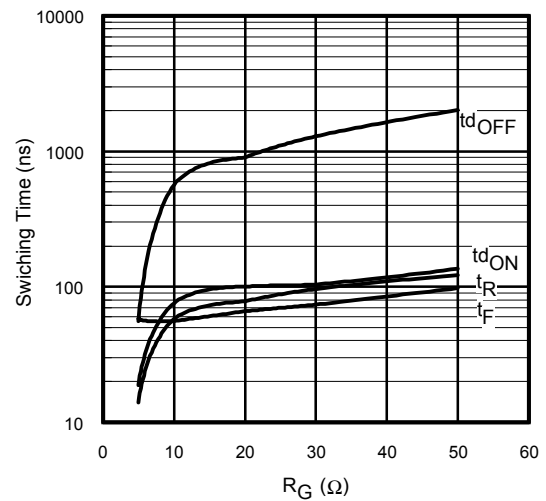

**Fig. 16** - Typ. Switching Time vs.  $R_G$   
 $T_J = 150^\circ\text{C}$ ;  $L = 250\mu\text{H}$ ;  $V_{CE} = 600\text{V}$   
 $I_{CE} = 40\text{A}$ ;  $V_{GE} = 15\text{V}$

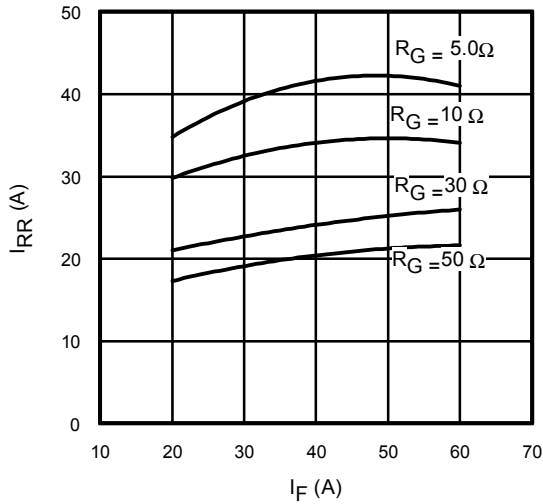

Fig. 17 - Typical Diode  $I_{RR}$  vs.  $I_F$   
 $T_J = 125^\circ\text{C}$

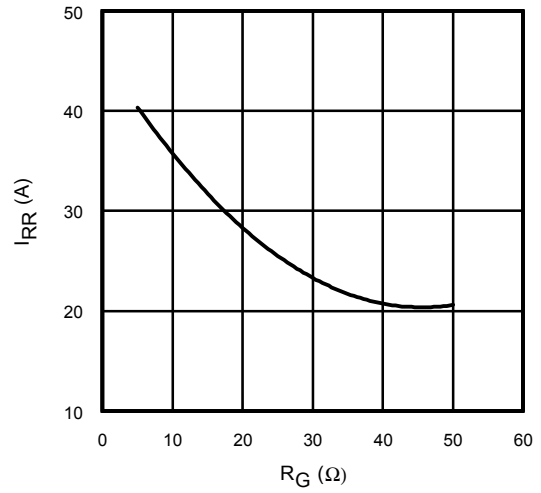

Fig. 18 - Typical Diode  $I_{RR}$  vs.  $R_G$   
 $T_J = 125^\circ\text{C}$ ;  $I_F = 40\text{A}$

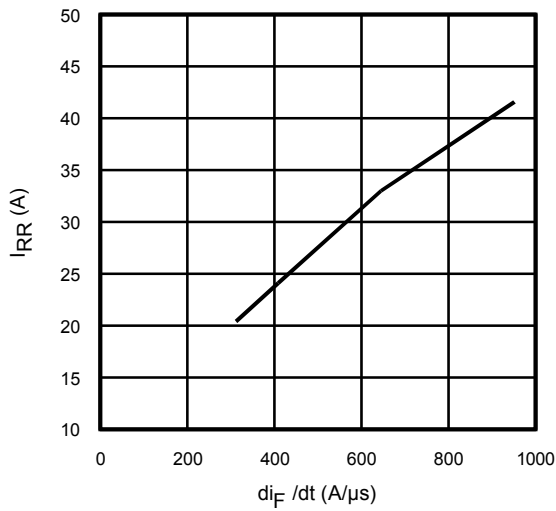

Fig. 19- Typical Diode  $I_{RR}$  vs.  $di_F/dt$   
 $V_{CC} = 600\text{V}$ ;  $V_{GE} = 15\text{V}$ ;  
 $I_{CE} = 40\text{A}$ ;  $T_J = 125^\circ\text{C}$

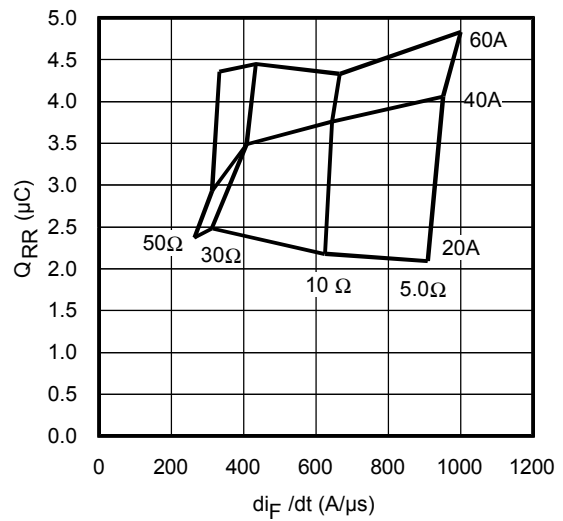
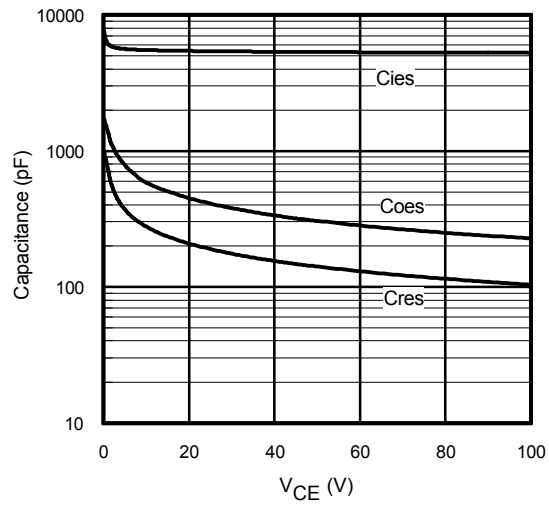
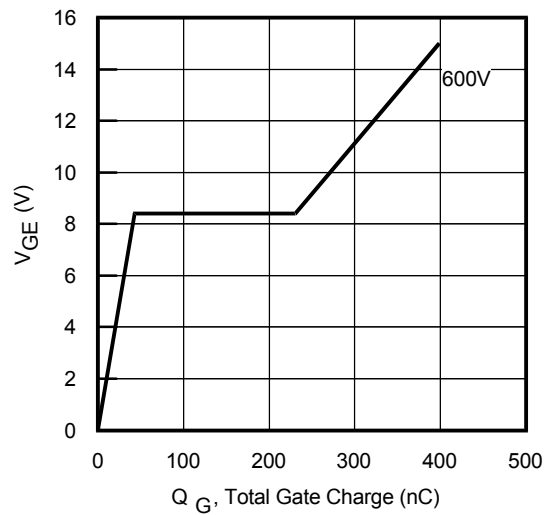

Fig. 20 - Typical Diode  $Q_{RR}$   
 $V_{CC} = 600\text{V}$ ;  $V_{GE} = 15\text{V}$ ;  $T_J = 125^\circ\text{C}$





**Fig. 21** - Typ. Capacitance vs. V<sub>CE</sub>  
 V<sub>GE</sub> = 0V; f = 1MHz



**Fig. 22** - Typical Gate Charge vs. V<sub>GE</sub>  
 I<sub>CE</sub> = 5.0A; L = 600μH

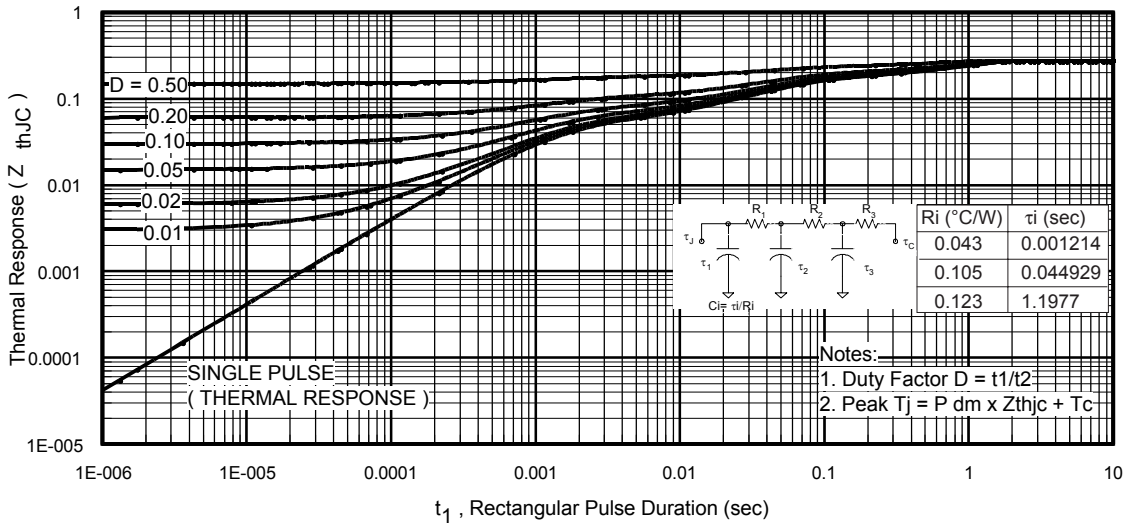

Fig 23. Maximum Transient Thermal Impedance, Junction-to-Case (IGBT)

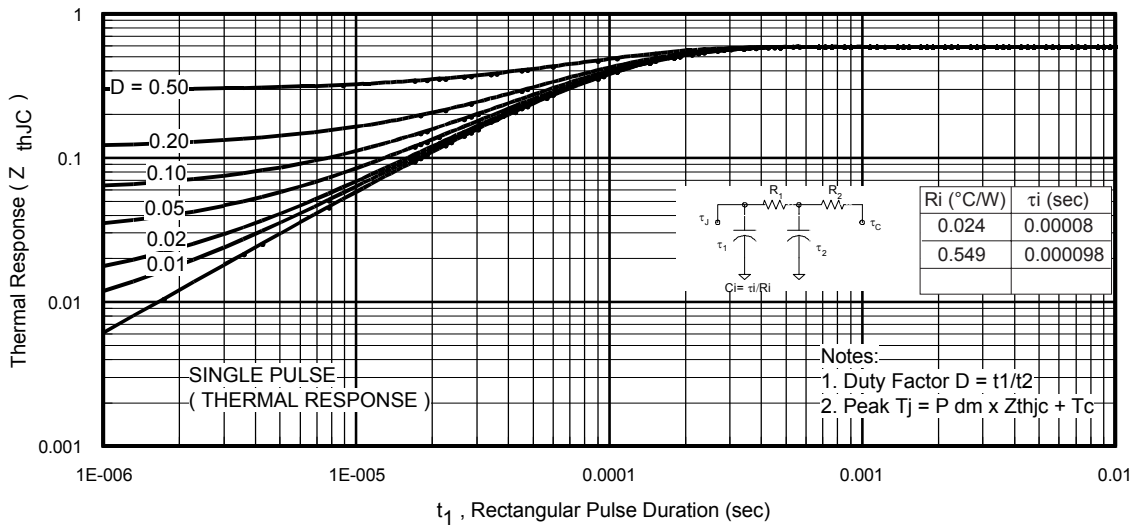

Fig 24. Maximum Transient Thermal Impedance, Junction-to-Case (DIODE)

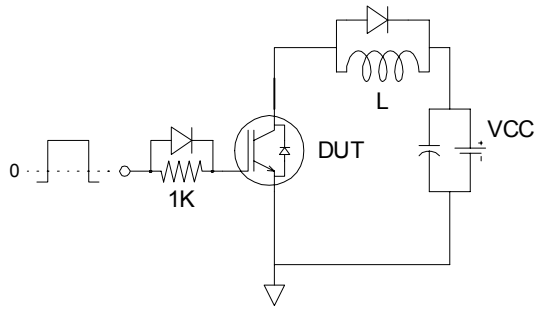

Fig. CT.1 - Gate Charge Circuit (turn-off)

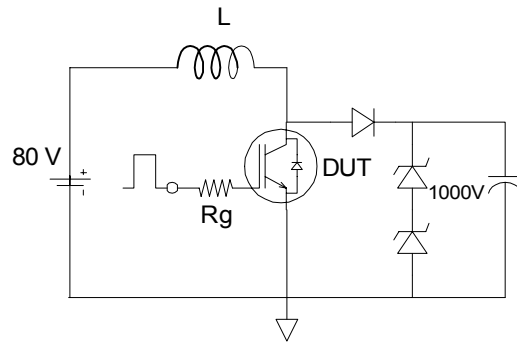

Fig. CT.2 - RBSOA Circuit

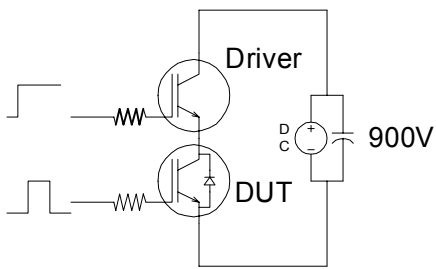

Fig. CT.3 - S.C. SOA Circuit

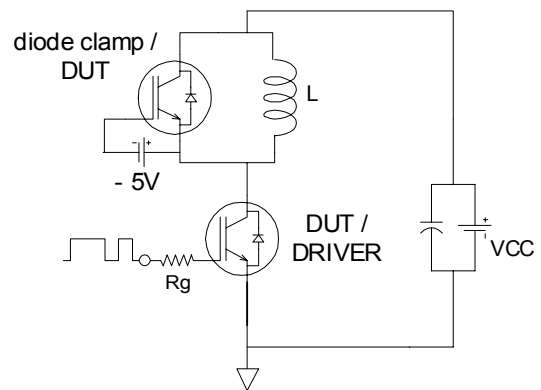
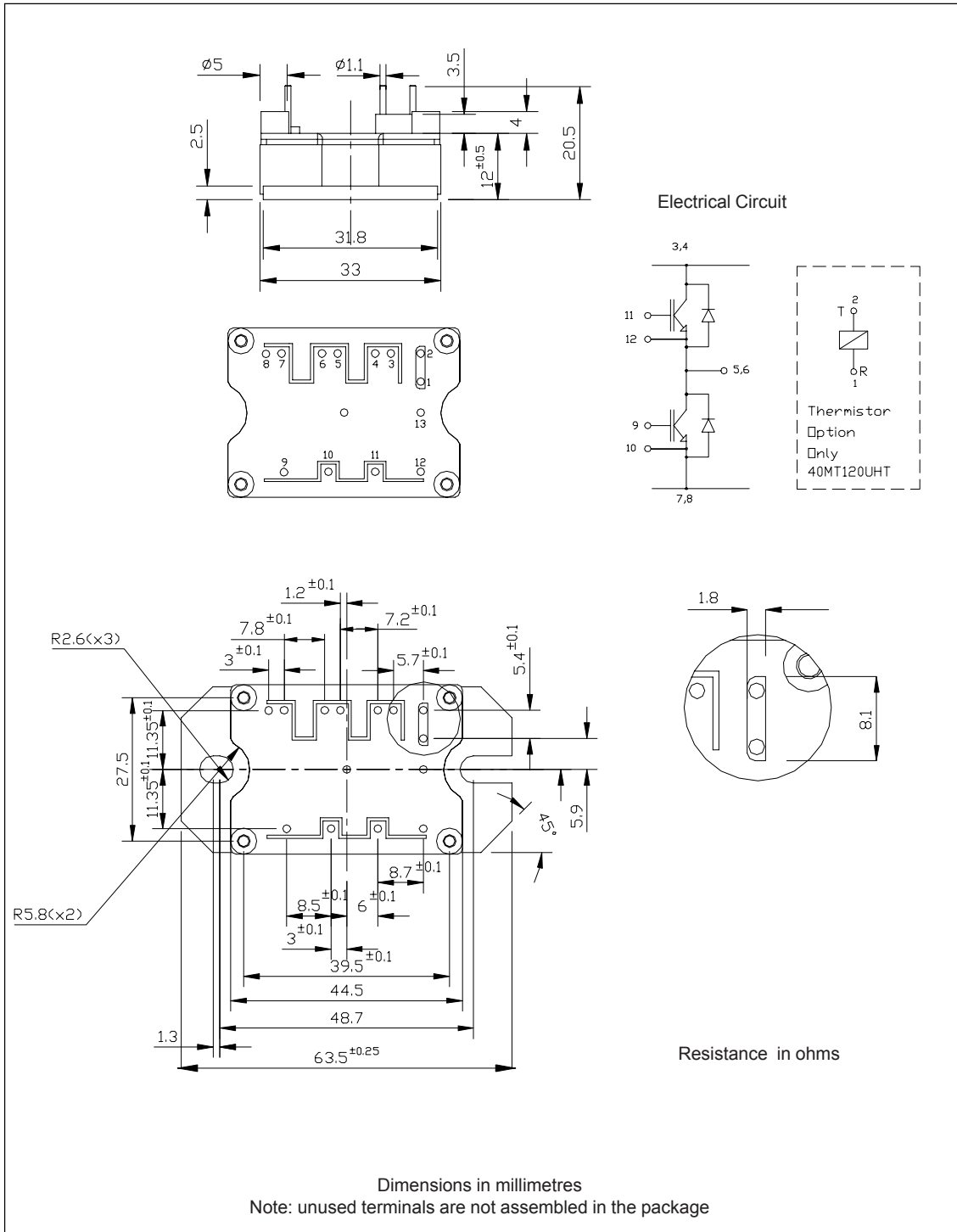

Fig. CT.4 - Switching Loss Circuit

**Outline Table**



### Ordering Information Table

Device Code	
40	MT
120	U
H	-
①	②
③	④
⑤	⑥

<p><b>1</b> - Current rating (40 = 40A)</p> <p><b>2</b> - Essential Part Number</p> <p><b>3</b> - Voltage code (120 = 1200V)</p> <p><b>4</b> - Speed/ Type (U = Ultra Fast IGBT)</p> <p><b>5</b> - Circuit Configuration (H = Half Bridge)</p> <p><b>6</b> - Special Option</p>	<div style="border: 1px solid black; padding: 5px; display: inline-block;">                 Empty = no special option                  T = Thermistor             </div>
---	--

Data and specifications subject to change without notice.  
 This product has been designed and qualified for Industrial Level.  
 Qualification Standards can be found on IR's Web site.