

CMOS QUAD LATCH

FEATURES



- ◆ Common Clock
- ◆ Positive- or Negative-Edge Clocking
- ◆ Q and \bar{Q} Outputs Available from Each Latch

DESCRIPTION

4042B devices contain four Latch circuits, each strobed by a common Clock. Complementary buffered outputs are available from each circuit.

Information present at the Data input is transferred to outputs Q and \bar{Q} during the Clock level which is programmed by the Polarity input. For Polarity = 0 the transfer occurs during the 0 Clock level and for Polarity = 1 the transfer occurs during the 1 Clock level. The outputs follow the Data inputs providing the Clock and Polarity levels defined above are present. When a Clock transition occurs (positive for Polarity = 0 and negative for Polarity = 1) the information present at the input during the Clock transition is retained at the outputs until an opposite Clock transition occurs.

TRUTH TABLE

CLOCK	POLARITY	Q
0	0	D
	0	LATCH
1	1	D
	1	LATCH

LOGIC DIAGRAMS

One of four latches

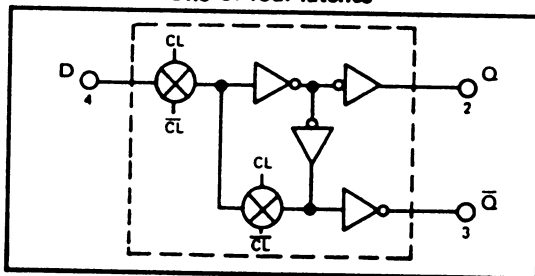

Clock Input Control

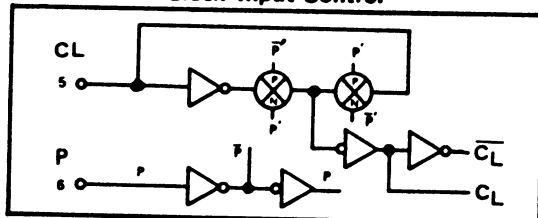

CONNECTION DIAGRAM

(all packages)

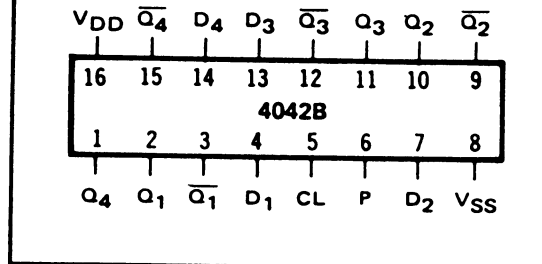

RECOMMENDED OPERATING CONDITIONS

For maximum reliability:

DC Supply Voltage $V_{DD} - V_{SS}$ 3 to 15 Vdc

Operating Temperature T_A

C -55 to +125 °C
E -40 to +85 °C

BLOCK DIAGRAM

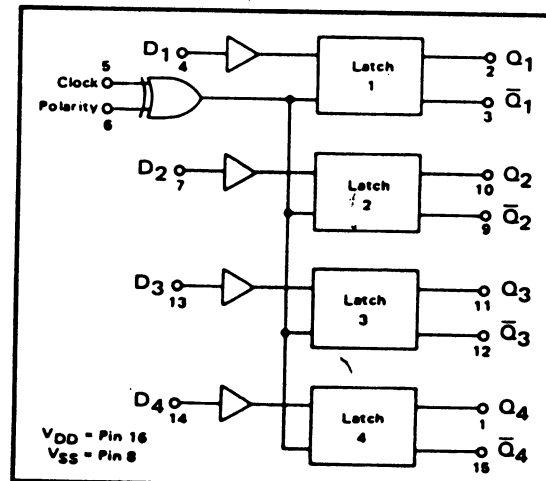

ELECTRICAL CHARACTERISTICS

STATIC CHARACTERISTICS¹

PARAMETER	V _{DD} (Vdc)	CONDITIONS	T _{LOW} ²		+25°C			T _{HIGH} ²		Units
			Min.	Max.	Min.	Typ.	Max.	Min.	Max.	
QUIESCENT DEVICE CURRENT	I _{DD}	V _{IN} =V _{SS} or V _{DD} All valid input combinations	-	5	-	1.0	5	-	150	μAdc
			-	10	-	2.0	10	-	300	
			-	15	-	4.0	20	-	600	

NOTES: ¹ Remaining Static Characteristics are listed under "4000B Series Family Specifications".

² T_{LOW} = -55°C for C
 = -40°C for E
 T_{HIGH} = +125°C for C
 = + 85°C for E

DYNAMIC CHARACTERISTICS (C_L = 50pF, T_A = 25°C)

PARAMETER		V _{DD} (Vdc)	Min.	Typ.	Max.	Units
PROPAGATION DELAY TIME From Data Inputs	t _{PLH} , t _{PHL}	5	-	110	220	ns
		10	-	55	110	
		15	-	40	80	
From Clock Polarity Inputs	t _{PLH} , t _{PHL}	5	-	150	300	ns
		10	-	75	150	
		15	-	50	100	
OUTPUT TRANSITION TIME	t _{TLH} , t _{THL}	5	-	100	200	ns
		10	-	50	100	
		15	-	40	80	
MINIMUM CLOCK PULSE WIDTH	PW _{CL}	5	-	100	200	ns
		10	-	50	100	
		15	-	30	60	
MAXIMUM CLOCK RISE AND FALL TIME	t _{rCL} , t _{fCL}	5	15	-	-	μs
		10	5	-	-	
		15	3	-	-	
MINIMUM DATA INPUT SETUP TIME	t _{setup}	5	-	-20	50	ns
		10	-	-10	30	
		15	-	-5	25	
MINIMUM DATA INPUT HOLD TIME	t _{hold}	5	-	0	100	ns
		10	-	0	50	
		15	-	0	40	

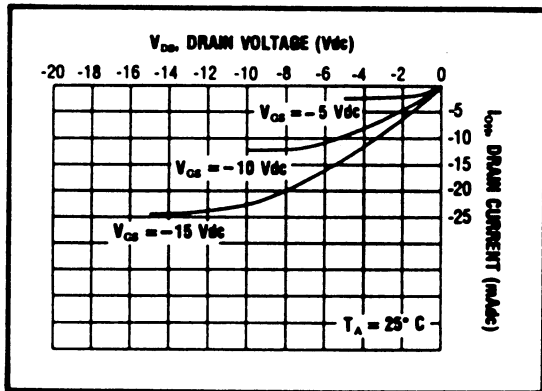

Typical P-Channel Source Current Characteristics

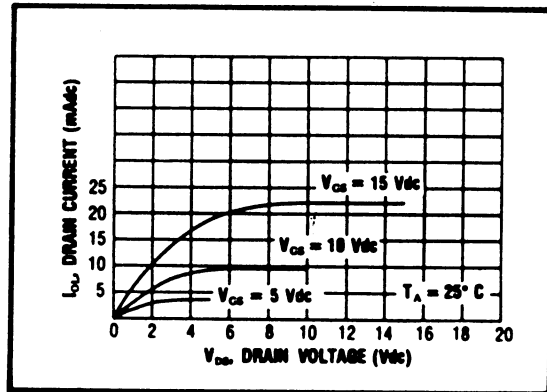

Typical N-Channel Sink Current Characteristics