

DATE: 2001. 06. 09

SPECIFICATION

PRODUCT : REMOCON MODULE

MODEL : 356VF6

OPTO ELECTRONICS CO., LTD.

1066-12 YOUNJANG-RI, JINAN-UP, JINAN-GUN

JEON-BUK, KOREA.

TEL : 82-63-433-4566~8

FAX : 82-63-433-4569

<http://www.e-oec.com>

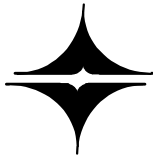



ELECTRONICS CO., LTD.

T I T L E
REMOCON PREAMP
356VF6

Document Number	OQSS-R-063
Revision Number	IR
Revision Date	2001. 06. 09.
P A G E	1 / 6

1. GENERAL DESCRIPTION

The 356VF6 is miniaturized receiver for infrared remote control systems.

PIN photo diode and preamplifier are assembled on lead frame, the epoxy package is designed as IR filter.

2. Application

AV equipment such as TV sets, VCRs and audio equipment.
HA equipment such as air conditioners and electric fans.

3. Outline

Refer to the attached drawing 356VF6

4. Features

- * Photo detector and preamplifier in one package
- * Enhanced immunity against all kinds of disturbance light
- * High performance photo diode and built-in excursive I · C
- * High speed response and output
- * Low consumption of electric power and easy use

5. Block Diagram

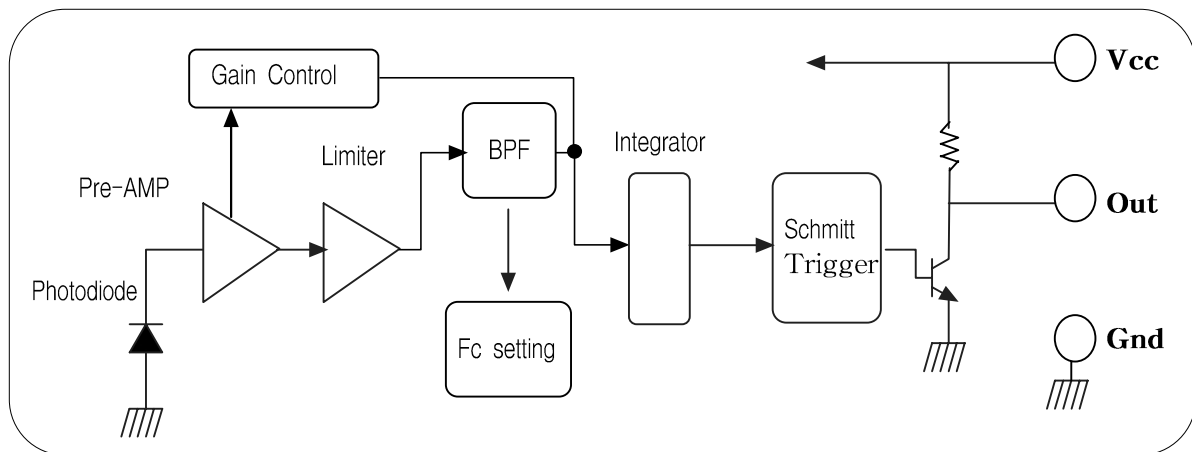

NOTE



ELECTRONICS CO., LTD.

T I T L E
REMOCON PREAMP
356VF6

Document Number	OQSS-R-063
Revision Number	IR
Revision Date	2001. 06. 09.
P A G E	2 / 6

6. Ratings and Characteristics

6-1. Absolute maximum ratings

(Ta=25°C)

Characteristics	Symbol	Value	Unit
Power supply voltage	Vcc	6.0	V
Operating temperature	Topr	-10 to +60	°C
Storage temperature	Tstg	-20 to +75	°C
Soldering temperature	Tsol	260 , 5 sec	°C

6-2. Electro-optical characteristics

* All values are at 25°C

(Ta=25°C)

Characteristic	Symbol	Condition	Min	Typ	Max	Unit	
Supply voltage	Vcc		4.5	5.0	5.5	V	
Current consumption	Icc	*1	0.3	-	2.0	mA	
Resonance frequency	Fo		-	38	-	KHz	
Peak wave length	λp		-	980	-	nm	
H level output voltage	Voh	*2	4.5	5.0	-	V	
L level output voltage	Vol	*2	-	0.2	0.4	V	
H level pulse width	Twh	*2	500	-	700	us	
L level pulse width	Twl		500	-	700	us	
Arrival distance	L	*2,3,4	±0 °	-	20	-	m
			±30°	-	15	-	
			±45°	-	10	-	
Output form	Active low						

◆ 1. No input signal, Vin=0V

◆ 2. The specifications 6-2 shall be satisfied under the following conditions

2-1. The burst wave forms shown bellow in the Fig 1 shall be transmitted by the standard transmitter.

The standard transmitter shall be specified of the burst wave form in the Fig 1 adjusted to Vout 200mVp-p upon Po measuring circuit Fig 2.

NOTE



ELECTRONICS CO., LTD.

T I T L E
REMOCON PREAMP
 356VF6

Document Number	OQSS-R-063
Revision Number	IR
Revision Date	2001. 06. 09.
P A G E	3 / 6

Fig 1. Output Waveform

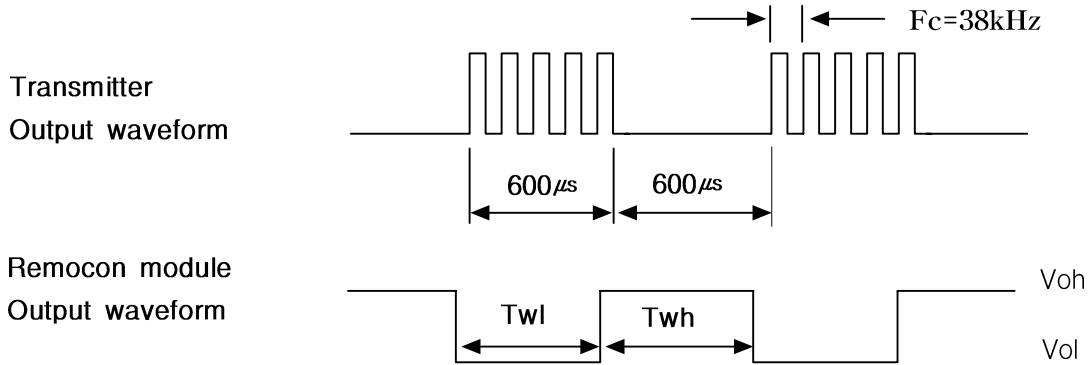
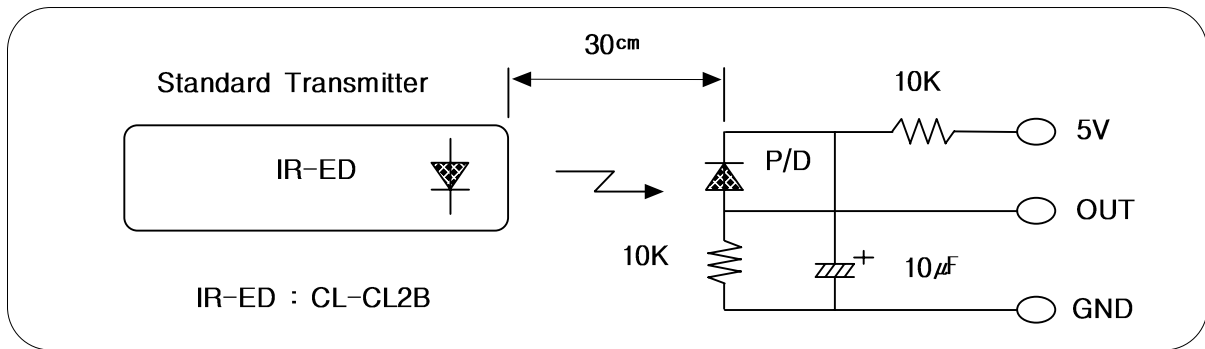
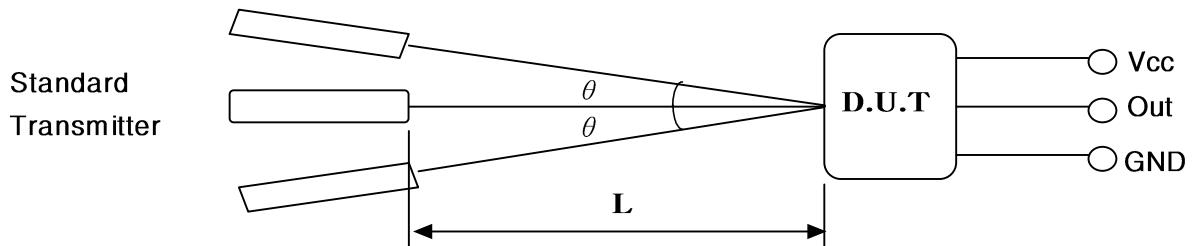

Fig 2. Po Measuring circuit



◆ 3. Arrival distance test condition



Where θ : Horizontal and vertical directions

D.U.T : Device under test

◆ 4. The arrival distance is measured in the darkness without disturbing noises.

NOTE



ELECTRONICS CO., LTD.

T I T L E
 REMOCON PREAMP
 356VF6

Document Number	OQSS-R-063
Revision Number	IR
Revision Date	2001. 06. 09.
P A G E	4 / 6

7. Reliability

Test items	Test conditions	Remarks
High temp high humid	Ta=40°C 90%RH t=96H	* 1, 2
Heat cycle	* 2, 3	
Fall test	* 4	

- * 1. Supply voltage 5V in the load test.
- * 2. Electro-optical chara. (6-2) shall satisfy the figure they be left 2H at normal condition.
- * 3. Heat cycle test as below Fig 3 for 20 cycles under no load.

Fig 3. heat cycle

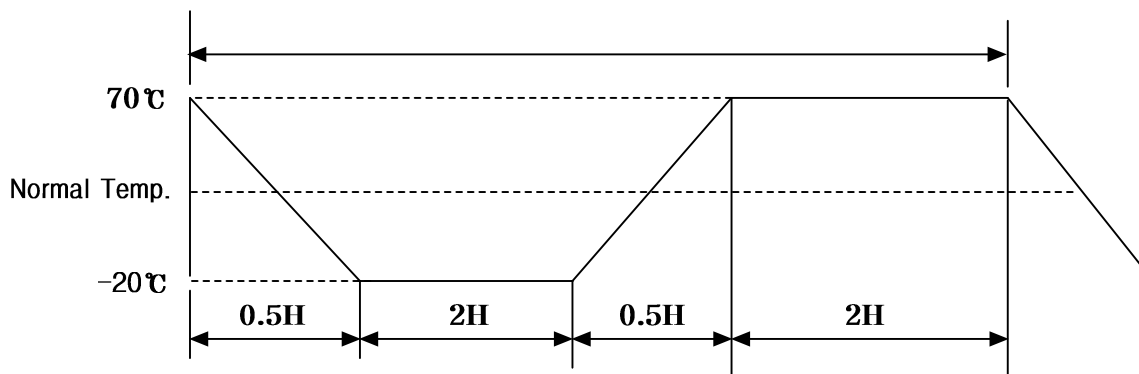

- ◆ 4. Fall test
 The test devices to fall three time onto hard wooden board from a level 75Cm

NOTE



ELECTRONICS CO., LTD.

T I T L E
REMOCON PREAMP
356VF6

Document Number	OQSS-R-063
Revision Number	IR
Revision Date	2001. 06. 09.
P A G E	5 / 6

8. The Others

In case of noisy power supply, please serially insert about 47ohm resistance and about 47uF Electrolytic capacitance in Vcc line as follows.

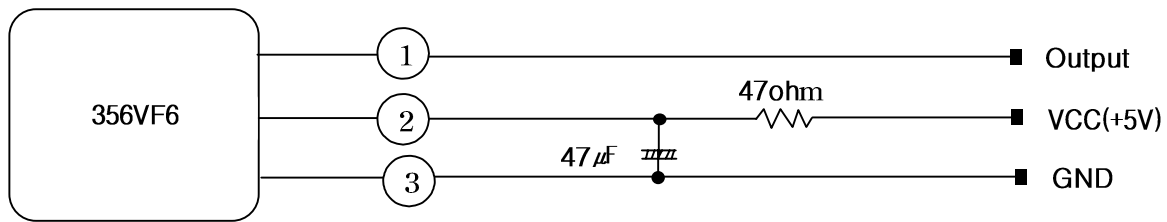

9. Precaution in handling

When soldering leave 2mm of minimum clearance between the resin and the soldering point.

NOTE



ELECTRONICS CO., LTD.

T I T L E
REMOCON PREAMP
356VF6

Document Number	OQSS-R-063
Revision Number	IR
Revision Date	2001. 06. 09.
P A G E	6 / 6

■ Typical Characteristics (Tamb = 25°C unless otherwise specified)

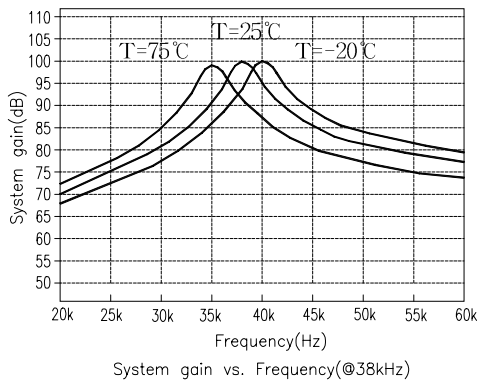
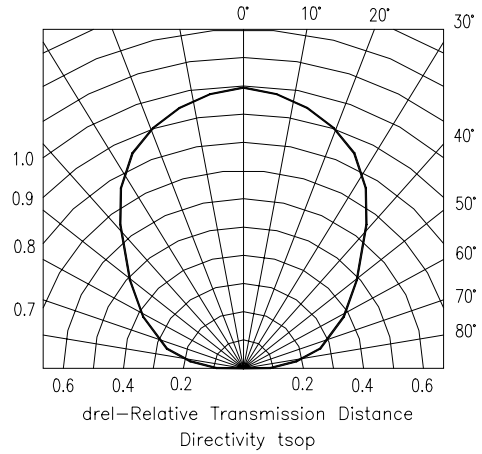
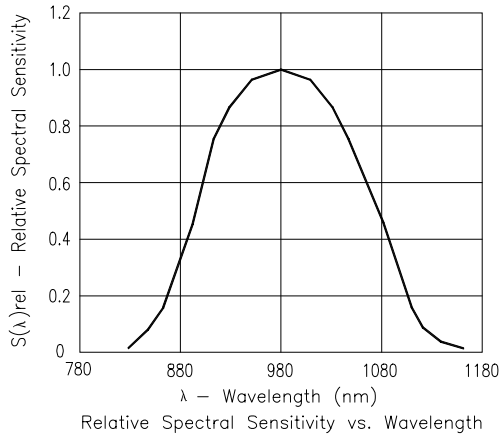

NOTE

P.C.B LAYOUT
(Top View)

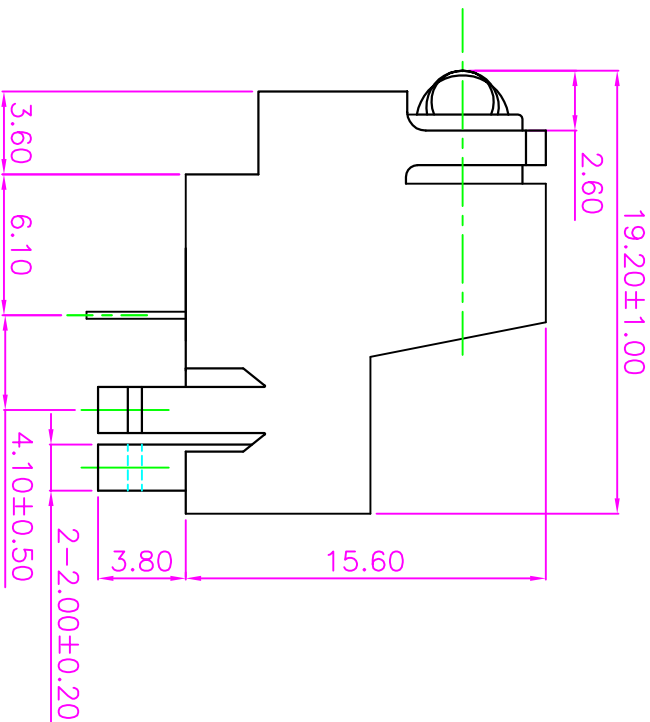
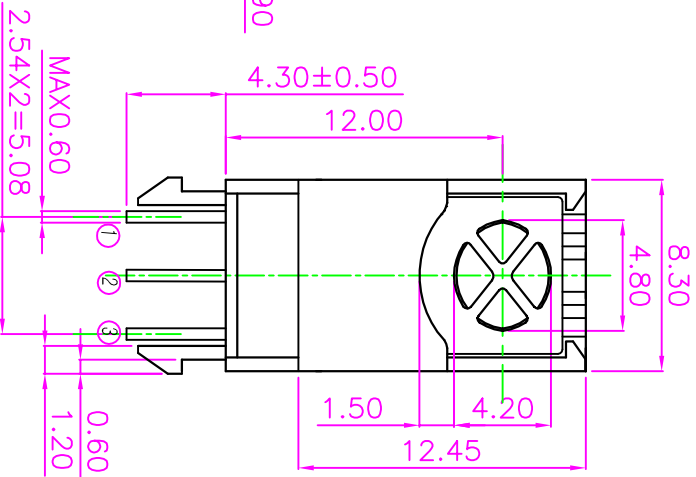
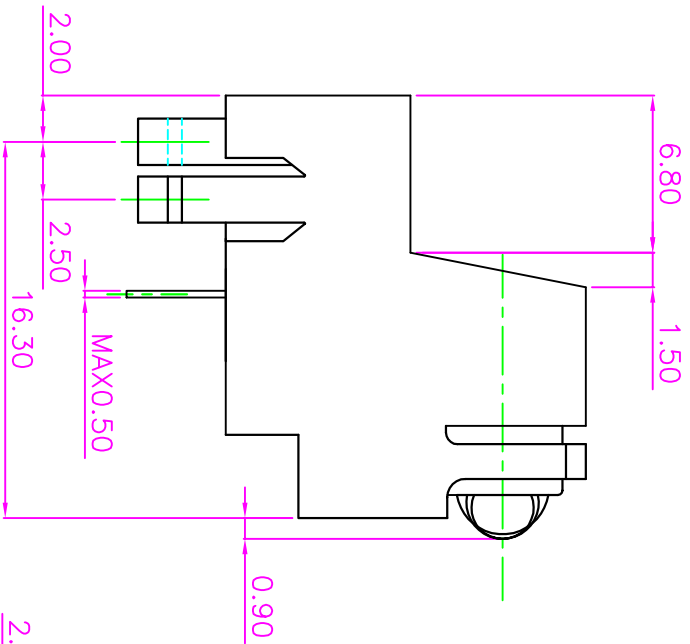
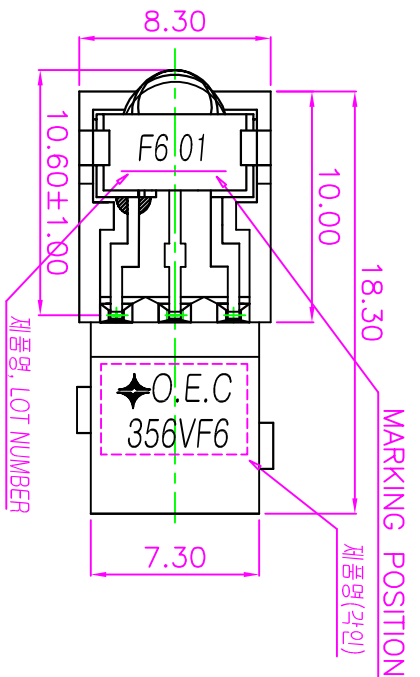
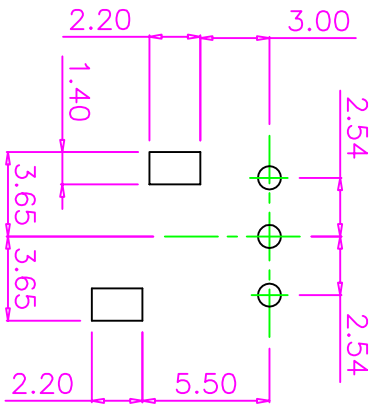

NOTE

1. OUT PUT
2. VCC(+5V)
3. GND

* GENERAL TOLERANCE : ±0.20
* PIN GUIDE MATERIAL : ABS, BLACK

DATE	2001.07.10	UNLESS OTHERWISE SPECIFIED, DIMENSIONS ARE IN MILLIMETERS AND TOLERANCES ARE AS FOLLOWS:
UNIT	mm	
SCALE	N/S	0 - 6 ±0.1
MATERIAL		6 - 15 ±0.15
		15 - 60 ±0.2
		60 - 200 ±0.3
		200 - ∞ ±0.5



TITLE

356VF6



OPTO ELECTRONICS CO., LTD

D.W.G NO.

OR01-063