

DEVELOPING

# 2SC5814 , 2SC5815 , 2SC5816 , 2SC5817

For Low Frequency Amplify Application  
Silicon NPN Epitaxial Type

## DESCRIPTION

2SC5814, 2SC5815, 2SC5816, 2SC5817 is a super mini package silicon NPN epitaxial type transistor. It is designed for low frequency voltage amplify application.

## FEATURE

- Facilitates miniaturization and high-density mounting
- Excellent linearity of DC forward current gain
- Low collector to emitter saturation voltage
- $V_{CE(sat)}=0.3V$  max (@ $I_C=30mA, I_B=1.5mA$ )

## APPLICATION

For hybrid IC , small type machine low frequency voltage amplify application

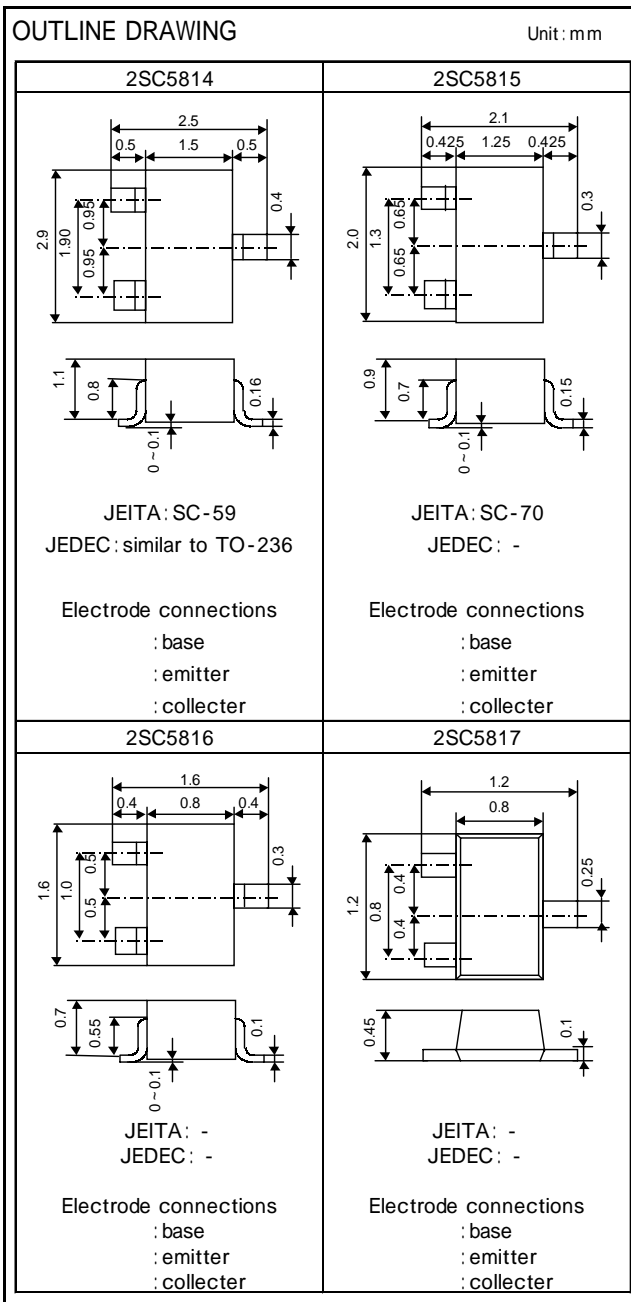

## MARKING

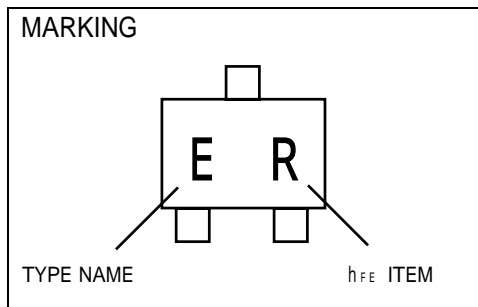

## MAXIMUM RATINGS (Ta=25 )

SYMBOL	PARAMETER	RATINGS				UNIT
		2SC5814	2SC5815	2SC5816	2SC5817	
$V_{CBO}$	Collector to Base voltage	60				V
$V_{EBO}$	Emitter to Base voltage	6				V
$V_{CEO}$	Collector to Emitter voltage	60				V
$I_C$	Collector current	125				mA
$P_C$	Collector dissipation	150		125	100	mW
$T_j$	Junction temperature	+ 125				
$T_{stg}$	Storage temperature	-55 ~ + 125				

DEVELOPING

2SC5814 , 2SC5815 , 2SC5816 , 2SC5817

For Low Frequency Amplify Application  
Silicon NPN Epitaxial Type

## ELECTRICAL CHARACTERISTICS (Ta=25 )

SYMBOL	PARAMETER	TEST CONDITIONS	LIMITS			UNIT
			MIN	TYP	MAX	
$V_{(BR)CEO}$	C to E break down voltage	$I_C=100\mu A, R_{BE}=\infty$	60			V
$I_{CBO}$	Collector cut off current	$V_{CB}=60V, I_E=0mA$			0.5	$\mu A$
$I_{EBO}$	Emitter cut off current	$V_{EB}=4V, I_C=0mA$			0.5	$\mu A$
$h_{FE}^*$	DC forward current gain	$V_{CE}=6V, I_C=1mA$	120		560	-
$h_{FE}$	DC forward current gain	$V_{CE}=6V, I_C=0.1mA$	70			-
$V_{CE(sat)}$	C to E saturation voltage	$I_C=30mA, I_B=1.5mA$			0.3	V
$f_T$	Gain band width product	$V_{CE}=6V, I_E=-10mA$		200		MHz
$C_{ob}$	Collector output capacitance	$V_{CB}=6V, I_E=0mA, f=1MHz$		1.5		pF

\* It shows  $h_{FE}$  classification in right table.

Item	Q	R	S
$h_{FE}$	120 ~ 270	180 ~ 390	270 ~ 560
Marking	EQ	ER	ES

Item	E	F
$h_{FE}$	150 ~ 300	250 ~ 500
Marking	EE	EF

2SC5814 2SC5815

COLLECTOR DISSIPATION VS.  
AMBIENT TEMPERATURE

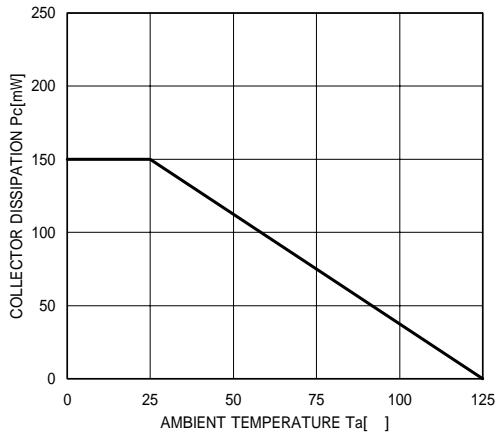

2SC5816

COLLECTOR DISSIPATION VS.  
AMBIENT TEMPERATURE

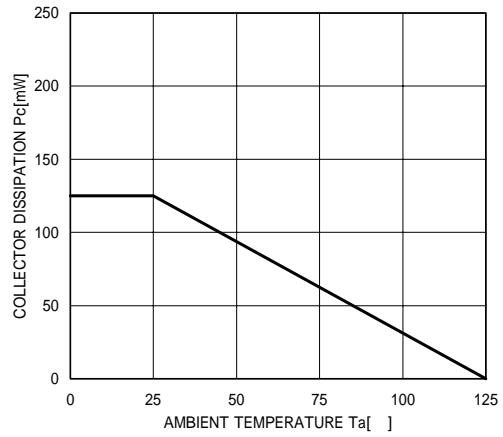

2SC5817

COLLECTOR DISSIPATION VS.  
AMBIENT TEMPERATURE

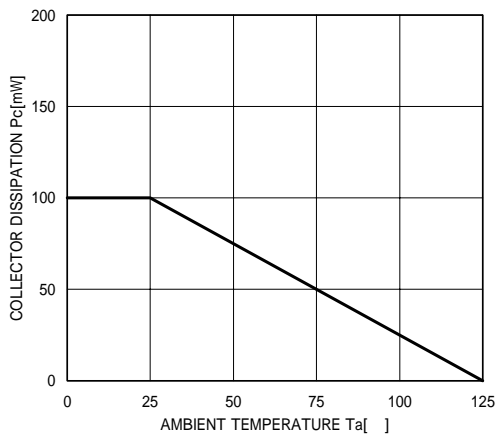

DEVELOPING

# 2SC5814 , 2SC5815 , 2SC5816 , 2SC5817

For Low Frequency Amplify Application  
Silicon NPN Epitaxial Type

COMMON EMITTER OUTPUT

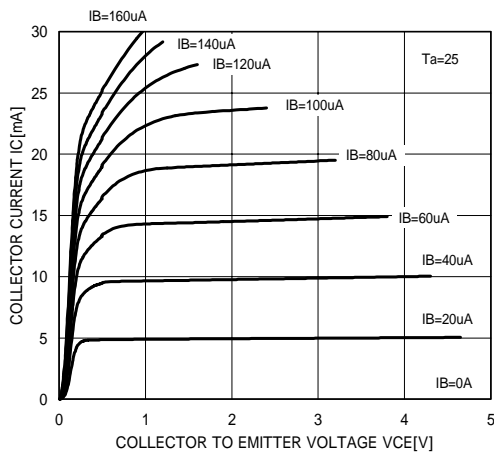

COMMON EMITTER TRANSFER

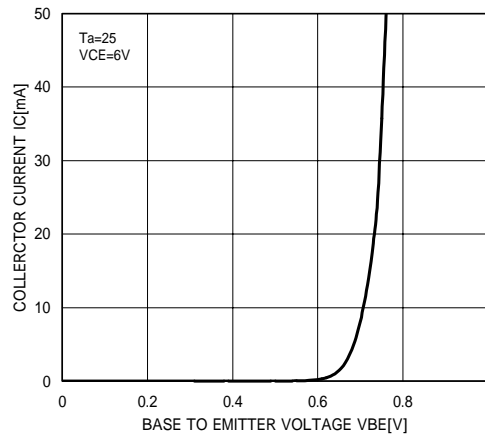

DC FORWARD CURRENT GAIN VS. COLLECTOR CURRENT

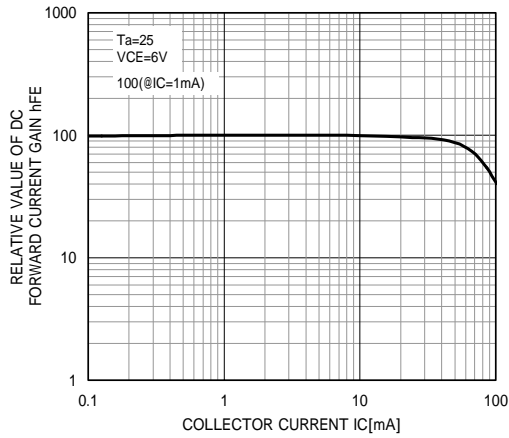

COLLECTOR-EMITTER SATURATION VOLTAGE VS COLLECTOR CURRENT

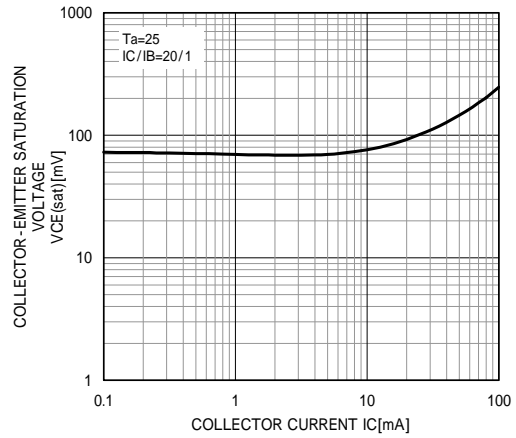

GAIN BAND WIDTH PRODUCT VS. EMITTER CURRENT

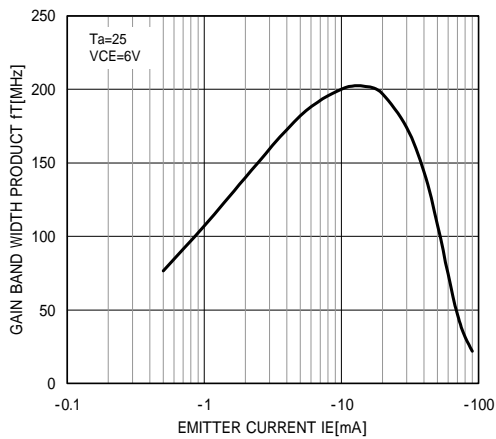

COLLECTOR OUTPUT CAPACITANCE VS. COLLECTOR TO BASE VOLTAGE

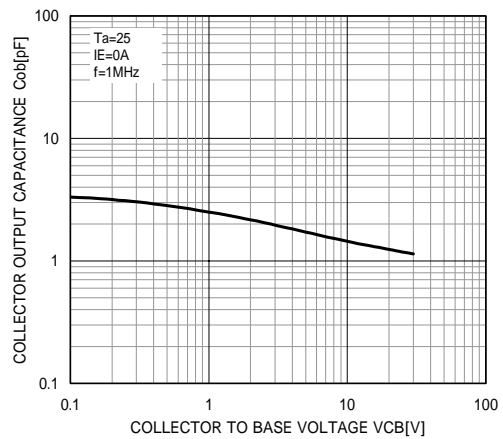



*Marketing division, Marketing planning department*

6-41 Tsukuba, Isahaya, Nagasaki, 854-0065 Japan

**Keep safety first in your circuit designs!**

•ISAHAYA Electronics Corporation puts the maximum effort into making semiconductor products better and more reliable, but there is always the possibility that trouble may occur with them. Trouble with semiconductors may lead to personal injury, fire or property damage. Remember to give due consideration to safety when making your circuit designs, with appropriate measures such as (1) placement of substitutive, auxiliary, (2) use of non-flammable material or (3) prevention against any malfunction or mishap.

**Notes regarding these materials**

- These materials are intended as a reference to our customers in the selection of the ISAHAYA products best suited to the customer's application; they don't convey any license under any intellectual property rights, or any other rights, belonging ISAHAYA or third party.
- ISAHAYA Electronics Corporation assumes no responsibility for any damage, or infringement of any third party's rights, originating in the use of any product data, diagrams, charts or circuit application examples contained in these materials.
- All information contained in these materials, including product data, diagrams and charts, represent information on products at the time of publication of these materials, and are subject to change by ISAHAYA Electronics Corporation without notice due to product improvements or other reasons. It is therefore recommended that customers contact ISAHAYA Electronics Corporation or an authorized ISAHAYA products distributor for the latest product information before purchasing product listed herein.
- ISAHAYA Electronics Corporation products are not designed or manufactured for use in a device or system that is used under circumstances in which human life is potentially at stake. Please contact ISAHAYA electronics corporation or an authorized ISAHAYA products distributor when considering the use of a product contained herein for any specific purposes, such as apparatus or systems for transportation, vehicular, medical, aerospace, nuclear, or undersea repeater use.
- The prior written approval of ISAHAYA Electronics Corporation is necessary to reprint or reproduce in whole or in part these materials.
- If these products or technologies are subject to the Japanese export control restrictions, they must be exported under a license from the Japanese government and cannot be imported into a country other than the approved destination. Any diversion or re-export contrary to the export control laws and regulations of Japan and/or the country of destination is prohibited.
- Please contact ISAHAYA Electronics Corporation or authorized ISAHAYA products distributor for further details on these materials or the products contained therein.