

NPN SILICON TRIPLE DIFFUSED TRANSISTOR FOR HIGH SPEED SWITCHING, HIGH VOLTAGE SWITCHING

DESCRIPTION

The 2SC4346 is a mold power transistor developed for high-speed switching, high voltage switching, and is ideal for use as a driver in devices such as switching regulators, DC/DC converters, and high-frequency power amplifiers.

FEATURES

- Small package, but can control for high-current
- Low collector saturation voltage
 $V_{CE(sat)} = 1.0 \text{ V MAX. (I}_c = 2.0 \text{ A)}$
- Ultra high-speed switching
 $t_f = 0.3 \mu\text{s MAX. (I}_c = 2.0 \text{ A)}$
- Base reverse bias safe operating area is wide
 $V_{CEX(SUS)1} = 450 \text{ V MIN. (I}_c = 2.0 \text{ A)}$

ORDERING INFORMATION

PART NUMBER	PACKAGE
2SC4346	TO-251 (MP-3)
2SC4346-Z	TO-252 (MP-3Z)

ABSOLUTE MAXIMUM RATINGS (T_A = 25°C)

Collector to Base Voltage	V _{CBO}	500	V
Collector to Emitter Voltage	V _{CEO}	400	V
Emitter to Base Voltage	V _{EBO}	8.0	V
Collector Current (DC)	I _{C(DC)}	5.0	A
Collector Current (pulse)	I _{C(pulse)} ^{Note1}	10	A
Base current (DC)	I _{B(DC)}	2.5	A
Total Power Dissipation	P _{T1} (T _C = 25°C)	18	W
Total Power Dissipation	P _{T2} (T _A = 25°C)	1.0 ^{Note2} , 2.0 ^{Note3}	W
Junction Temperature	T _j	150	°C
Storage Temperature	T _{stg}	-55 to +150	°C

- Notes**
1. PW ≤ 10 ms, Duty Cycle ≤ 50%
 2. Mounted on print board
 3. Mounted on ceramic substrate of 7.5 mm² x 0.7 mm

The information in this document is subject to change without notice. Before using this document, please confirm that this is the latest version.
Not all products and/or types are available in every country. Please check with an NEC Electronics sales representative for availability and additional information.

ELECTRICAL CHARACTERISTICS (T_A = 25°C)

CHARACTERISTICS	SYMBOL	TEST CONDITIONS	MIN.	TYP.	MAX.	UNIT
Collector to Emitter Voltage	V _{CEO(SUS)}	I _C = 2.0 A, I _{B1} = 0.4 A, L = 1 mH	400			V
	V _{CEX(SUS)1}	I _C = 2.0 A, I _{B1} = -I _{B2} = 0.4 A, L = 180 μH, Clamped	450			V
	V _{CEX(SUS)2}	I _C = 4.0 A, I _{B1} = 1.0 A, -I _{B2} = 0.4 A, L = 180 μH, Clamped	400			V
Collector Cut-off Current	I _{CB0}	V _{CB} = 400 V, I _E = 0			10	μA
	I _{CER}	V _{CB} = 400 V, R _{BE} = 51 Ω, T _A = 125°C			1.0	mA
	I _{CEX1}	V _{CB} = 400 V, V _{BE(OFF)} = -5 V			100	μA
	I _{CEX2}	V _{CB} = 400 V, V _{BE(OFF)} = -5 V, T _A = 125°C			1.0	mA
Emitter Cut-off Current	I _{EBO}	V _{EB} = 5.0 V, I _C = 0			10	μA
DC Current Gain ^{Note}	h _{FE1}	V _{CE} = 5.0 V, I _C = 5 mA	15			
	h _{FE2}	V _{CE} = 5.0 V, I _C = 0.5 A	20		80	
	h _{FE3}	V _{CE} = 5.0 V, I _C = 2.0 A	10			
Collector Saturation Voltage ^{Note}	V _{CE(sat)}	I _C = 2.0 A, I _B = 0.4 A		0.5	1.0	V
Base Saturation Voltage ^{Note}	V _{BE(sat)}	I _C = 2.0 A, I _B = 0.4 A		1.0	1.5	V
Turn-on Time	t _{on}	I _C = 2.0 A, R _L = 75 Ω			0.7	μs
Storage Time	t _{stg}	I _{B1} = -I _{B2} = 0.4 A, V _{CC} ≐ 150 V			2.5	μs
Fall Time	t _f	See Test Circuit			0.3	μs

Note Pulsed

h_{FE} CLASSIFICATION

Marking	M	L	K
h _{FE2}	20 to 40	30 to 60	40 to 80

SWITCHING TIME (t_{on}, t_{stg}, t_f) TEST CIRCUIT

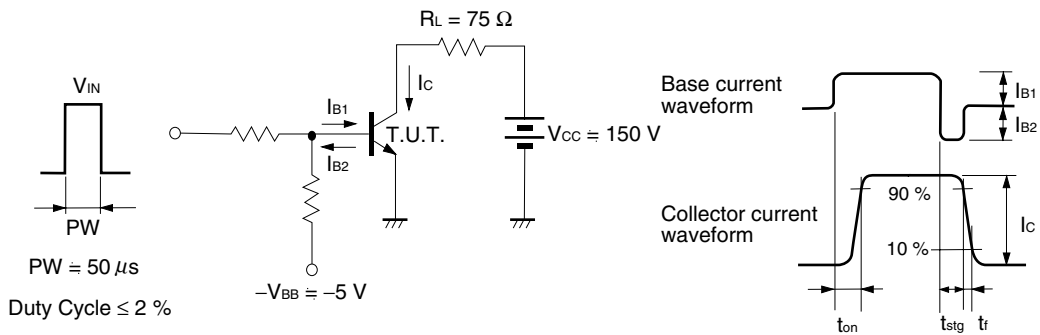

TYPICAL CHARACTERISTICS (T_A = 25°C)

TOTAL POWER DISSIPATION vs. AMBIENT TEMPERATURE

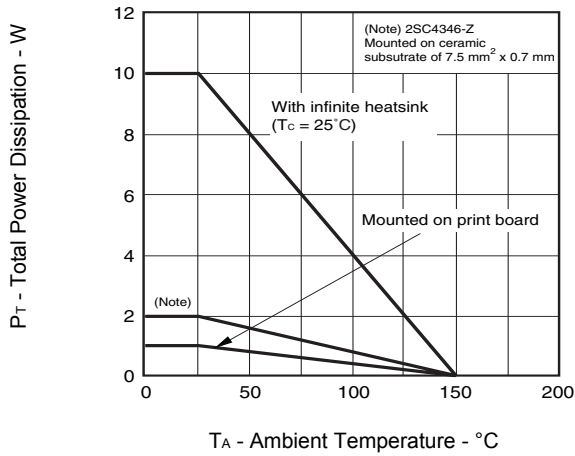

FORWARD BIAS SAFE OPERATING AREA

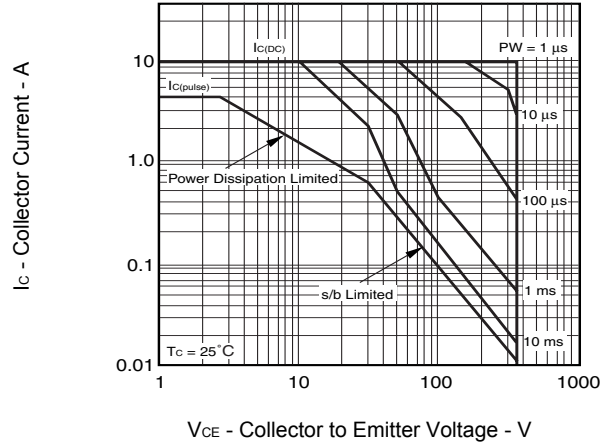

COLLECTOR CURRENT vs. COLLECTOR TO EMITTER VOLTAGE

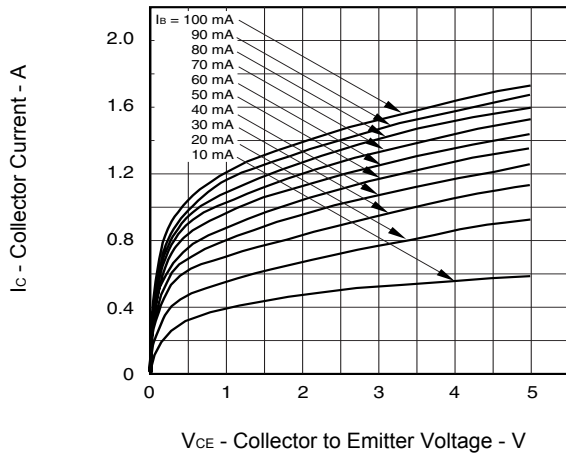

DC CURRENT GAIN vs. COLLECTOR CURRENT

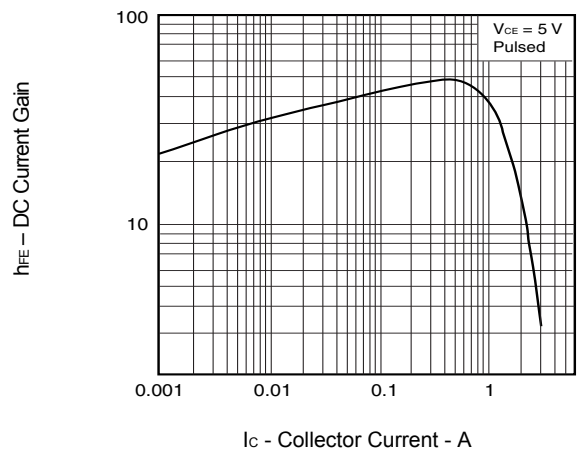

COLLECTOR AND BASE SATURATION VOLTAGE vs. COLLECTOR CURRENT

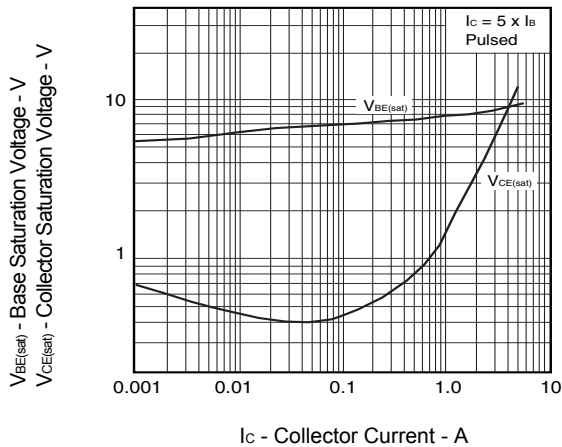

TURN-ON, STORAGE TIME AND FALL TIME vs. COLLECTOR CURRENT

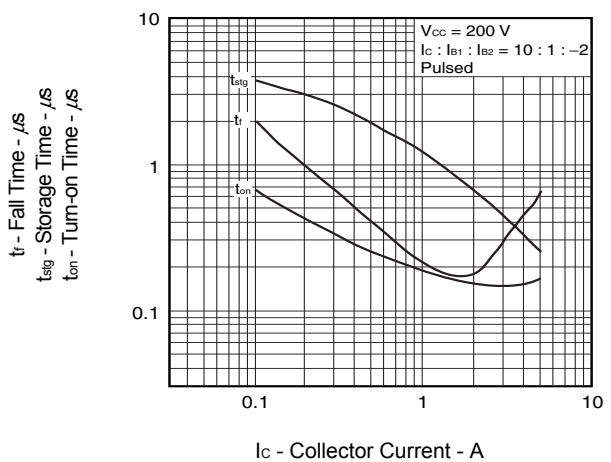

PACKAGE DRAWINGS (Unit: mm)

★ 1) TO-251 (MP-3)

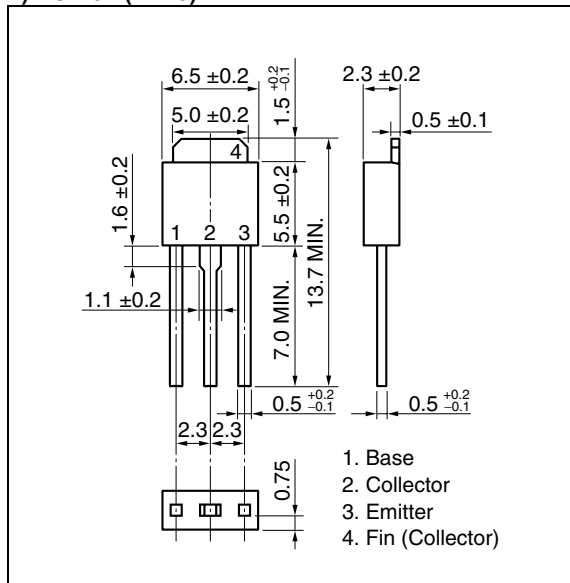

2) TO-252 (MP-3Z)

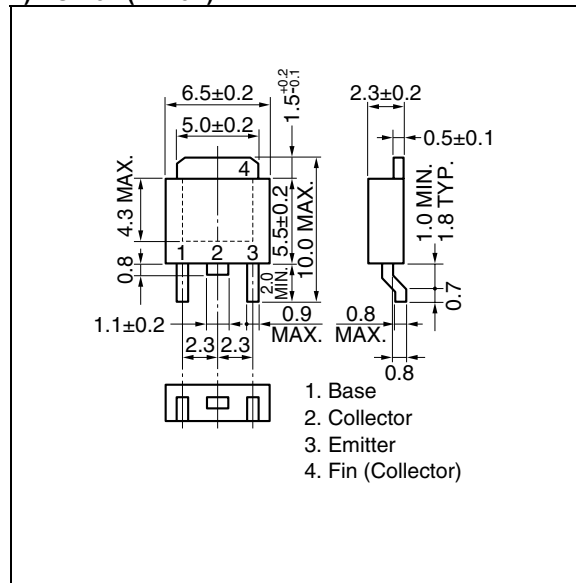

- **The information in this document is current as of August, 2004. The information is subject to change without notice. For actual design-in, refer to the latest publications of NEC Electronics data sheets or data books, etc., for the most up-to-date specifications of NEC Electronics products. Not all products and/or types are available in every country. Please check with an NEC Electronics sales representative for availability and additional information.**
- No part of this document may be copied or reproduced in any form or by any means without the prior written consent of NEC Electronics. NEC Electronics assumes no responsibility for any errors that may appear in this document.
- NEC Electronics does not assume any liability for infringement of patents, copyrights or other intellectual property rights of third parties by or arising from the use of NEC Electronics products listed in this document or any other liability arising from the use of such products. No license, express, implied or otherwise, is granted under any patents, copyrights or other intellectual property rights of NEC Electronics or others.
- Descriptions of circuits, software and other related information in this document are provided for illustrative purposes in semiconductor product operation and application examples. The incorporation of these circuits, software and information in the design of a customer's equipment shall be done under the full responsibility of the customer. NEC Electronics assumes no responsibility for any losses incurred by customers or third parties arising from the use of these circuits, software and information.
- While NEC Electronics endeavors to enhance the quality, reliability and safety of NEC Electronics products, customers agree and acknowledge that the possibility of defects thereof cannot be eliminated entirely. To minimize risks of damage to property or injury (including death) to persons arising from defects in NEC Electronics products, customers must incorporate sufficient safety measures in their design, such as redundancy, fire-containment and anti-failure features.
- NEC Electronics products are classified into the following three quality grades: "Standard", "Special" and "Specific".

The "Specific" quality grade applies only to NEC Electronics products developed based on a customer-designated "quality assurance program" for a specific application. The recommended applications of an NEC Electronics product depend on its quality grade, as indicated below. Customers must check the quality grade of each NEC Electronics product before using it in a particular application.

"Standard": Computers, office equipment, communications equipment, test and measurement equipment, audio and visual equipment, home electronic appliances, machine tools, personal electronic equipment and industrial robots.

"Special": Transportation equipment (automobiles, trains, ships, etc.), traffic control systems, anti-disaster systems, anti-crime systems, safety equipment and medical equipment (not specifically designed for life support).

"Specific": Aircraft, aerospace equipment, submersible repeaters, nuclear reactor control systems, life support systems and medical equipment for life support, etc.

The quality grade of NEC Electronics products is "Standard" unless otherwise expressly specified in NEC Electronics data sheets or data books, etc. If customers wish to use NEC Electronics products in applications not intended by NEC Electronics, they must contact an NEC Electronics sales representative in advance to determine NEC Electronics' willingness to support a given application.

(Note)

- (1) "NEC Electronics" as used in this statement means NEC Electronics Corporation and also includes its majority-owned subsidiaries.
- (2) "NEC Electronics products" means any product developed or manufactured by or for NEC Electronics (as defined above).