

PNP SILICON EPITAXIAL TRANSISTOR FOR HIGH-SPEED SWITCHING

The 2SA1847 is a power transistor developed for high-speed switching and features a high h_{FE} at low $V_{CE(sat)}$. This transistor is ideal for use as a driver in DC/DC converters and actuators.

In addition, this transistor features a package that can be auto-mounted in radial taping specifications, thus contributing to mounting cost reduction.

FEATURES

- Auto-mount possible in radial taping specifications
- Resin-molded insulation type package with power rating of 1.8 W in stand-alone conditions
- High h_{FE} and low $V_{CE(sat)}$:
 $V_{CE(sat)} = -0.3 \text{ V MAX. @ } I_C = -6.0 \text{ V, } I_B = -0.3 \text{ A}$
 $h_{FE} \geq 100 \quad \text{@ } V_{CE} = -2.0 \text{ V, } I_C = -2.0 \text{ A}$
- Fast switching speed

ABSOLUTE MAXIMUM RATINGS ($T_a = 25^\circ\text{C}$)

Parameter	Symbol	Conditions	Ratings	Unit
Collector to base voltage	V_{CBO}		-150	V
Collector to emitter voltage	V_{CEO}		-100	V
Emitter to base voltage	V_{EBO}		-7.0	V
Collector current (DC)	$I_{C(DC)}$		-10	A
Collector current (pulse)	$I_{C(pulse)}$	$PW \leq 300 \mu\text{s}$, duty cycle $\leq 2\%$	-20	A
Base current (DC)	$I_{B(DC)}$		-6.0	A
Total power dissipation	P_T	$T_a = 25^\circ\text{C}$	1.8	W
Junction temperature	T_j		150	$^\circ\text{C}$
Storage temperature	T_{stg}		-55 to +150	$^\circ\text{C}$

The information in this document is subject to change without notice. Before using this document, please confirm that this is the latest version.
 Not all devices/types available in every country. Please check with local NEC representative for availability and additional information.

ELECTRICAL CHARACTERISTICS (Ta = 25°C)

Parameter	Symbol	Conditions	MIN.	TYP.	MAX.	Unit
Collector cutoff current	ICBO	V _{CB} = -100 V, I _E = 0			-10	μA
Collector cutoff current	ICER	V _{CE} = -100 V, R _{EB} = 50 Ω Ta = 125°C			-1.0	mA
Collector cutoff current	ICEX1	V _{CE} = -100 V, V _{BE(off)} = 1.5 V			-10	μA
Collector cutoff current	ICEX2	V _{CE} = -100 V, V _{BE(off)} = 1.5 V Ta = 125°C			-1.0	mA
Emitter cutoff current	IEBO	V _{EB} = -5.0 V, I _C = 0			-10	μA
DC current gain	h _{FE1} *	V _{CE} = -2.0 V, I _C = -0.5 A	100			-
DC current gain	h _{FE2} *	V _{CE} = -2.0 V, I _C = -2.0 A	100		400	-
DC current gain	h _{FE3} *	V _{CE} = -2.0 V, I _C = -6.0 A	60			-
Collector saturation voltage	V _{CE(sat)1} *	I _C = -6.0 A, I _B = -0.3 A			-0.3	V
Collector saturation voltage	V _{CE(sat)2} *	I _C = -8.0 A, I _B = -0.4 A			-0.5	V
Base saturation voltage	V _{BE(sat)1} *	I _C = -6.0 A, I _B = -0.3 A			-1.2	V
Base saturation voltage	V _{BE(sat)2} *	I _C = -8.0 A, I _B = -0.4 A			-1.5	V
Gain bandwidth product	f _T	V _{CE} = -10 V, I _C = -0.5 A		150		MHz
Collector capacitance	C _{ob}	V _{CB} = -10 V, I _E = 0, f = 1 MHz		250		pF
Turn-on time	t _{on}	I _C = -6.0 A			0.3	μs
Storage time	t _{stg}	I _{B1} = -I _{B2} = -0.3 A			1.5	μs
Fall time	t _f	R _L = 8.3 Ω, V _{CC} = -50 V			0.4	μs

* Pulse test PW ≤ 350 μs, duty cycle ≤ 2%

h_{FE} CLASSIFICATION

Marking	M	L	K
h _{FE}	100 to 200	150 to 300	200 to 400

PACKAGE DRAWING (UNIT: mm)

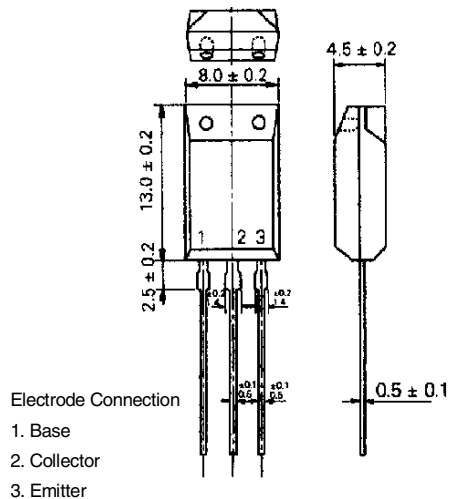

TAPING SPECIFICATION

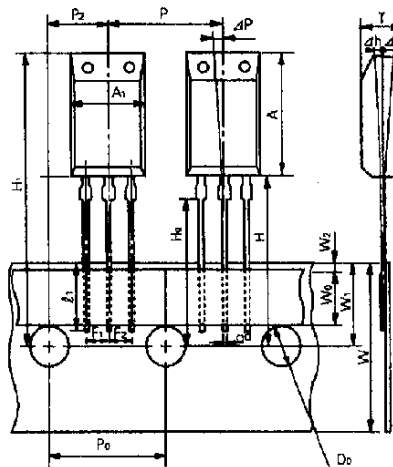

A ₁	8.0 ± 0.2
A	13.0 ± 0.2
D ₀	φ4.0 ± 0.2
d	0.5 ± 0.1
F ₁	2.5 ^{+0.4} _{-0.1}
F ₂	2.5 ^{+0.4} _{-0.1}
H	20.0 MAX.
H ₀	16.0 ± 0.5
H ₁	32.2 MAX.
Δh	0 ± 1.0
ℓ ₁	2.5 MIN.
P	12.7 ± 1.0
P ₀	12.7 ± 0.3
P ₂	6.35 ± 0.5
ΔP	0 ± 1.3
T	4.5 ± 0.2
W	18.0 ^{+1.0} _{-0.5}
W ₀	5.0 MIN.
W ₁	9.0 ± 0.5
W ₂	0.7 MIN.

TYPICAL CHARACTERISTICS (Ta = 25°C)

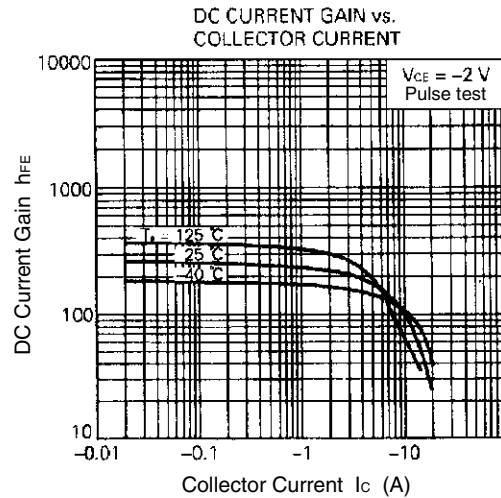
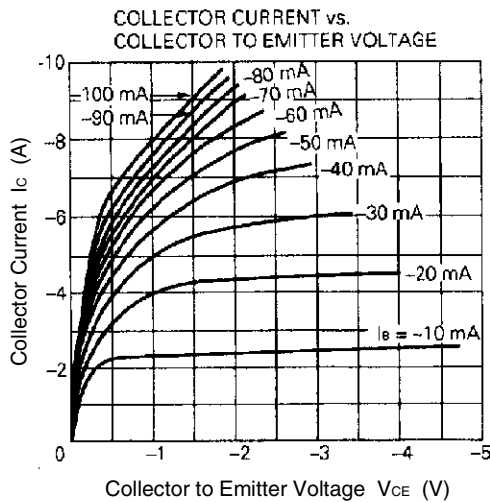
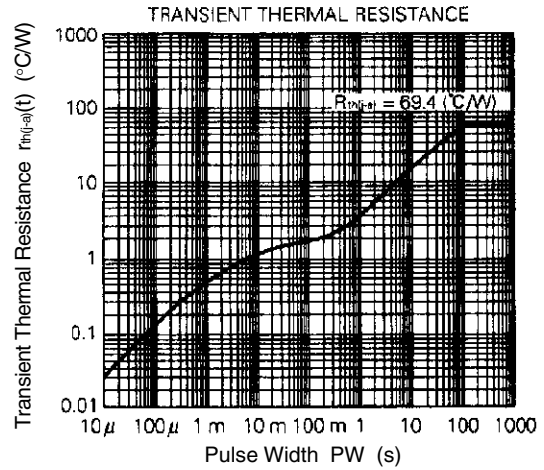
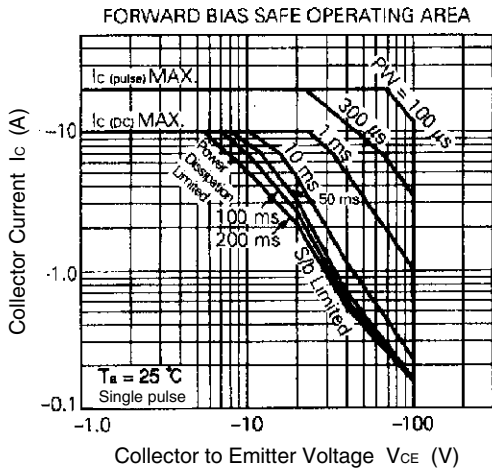
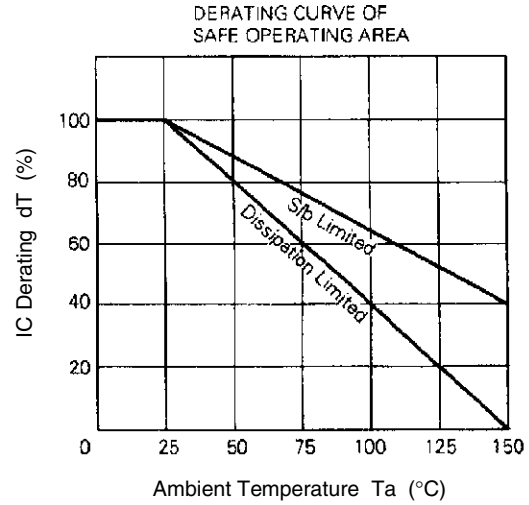
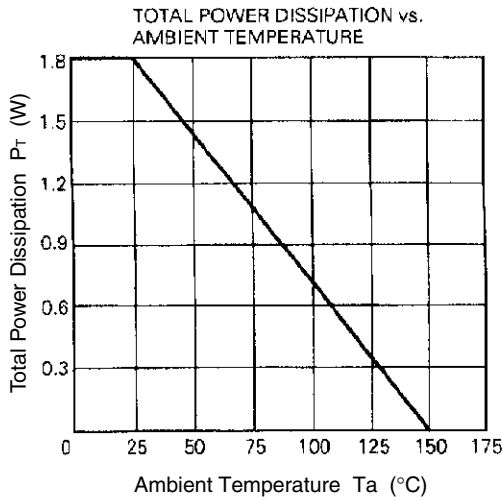

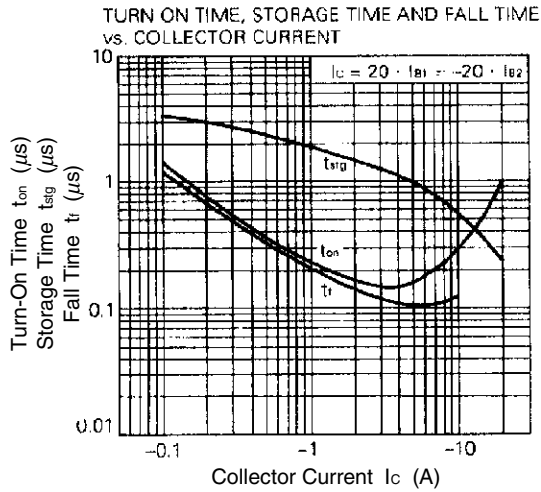
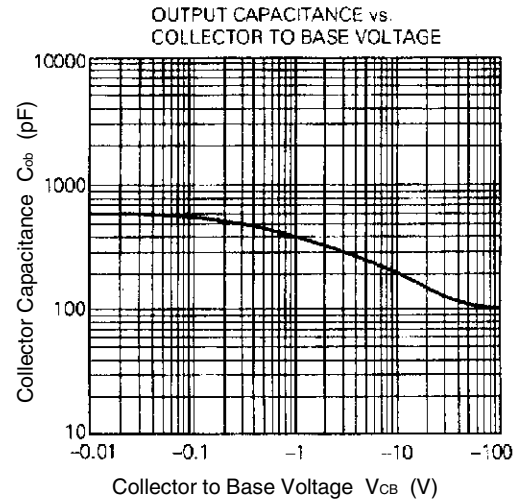
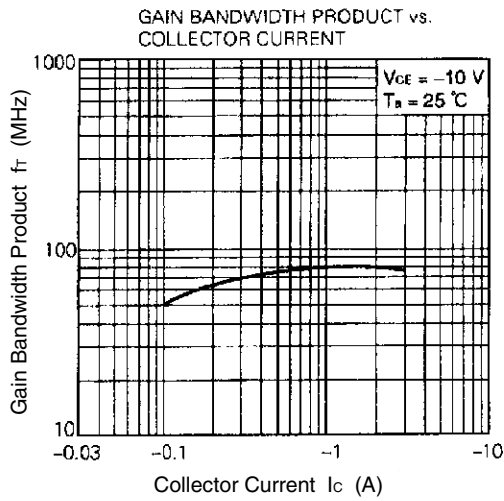
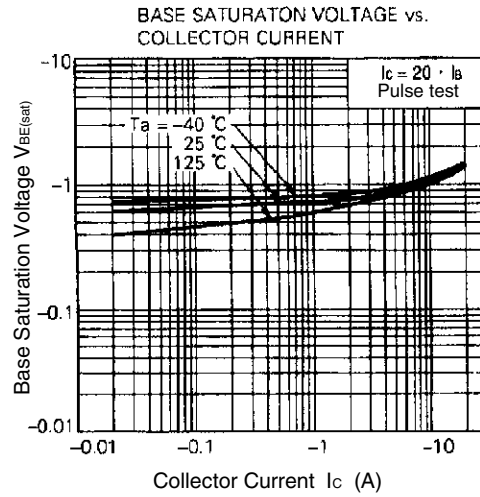
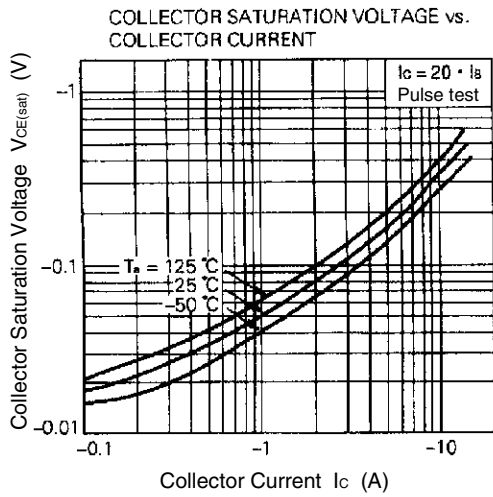

SWITCHING TIME (t_{on} , t_{stg} , t_t) TEST CIRCUIT

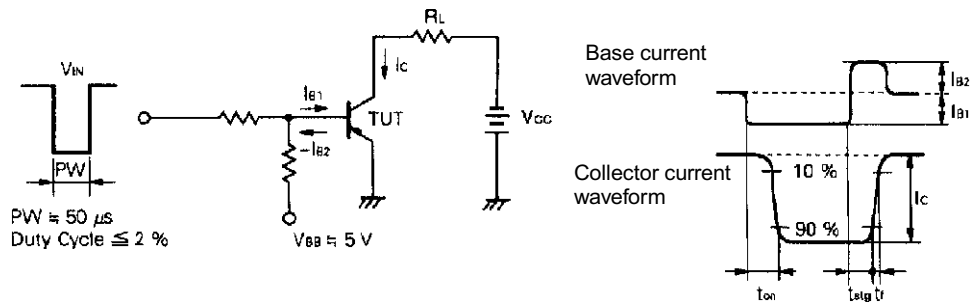

- **The information in this document is current as of July, 2001. The information is subject to change without notice. For actual design-in, refer to the latest publications of NEC's data sheets or data books, etc., for the most up-to-date specifications of NEC semiconductor products. Not all products and/or types are available in every country. Please check with an NEC sales representative for availability and additional information.**
- No part of this document may be copied or reproduced in any form or by any means without prior written consent of NEC. NEC assumes no responsibility for any errors that may appear in this document.
- NEC does not assume any liability for infringement of patents, copyrights or other intellectual property rights of third parties by or arising from the use of NEC semiconductor products listed in this document or any other liability arising from the use of such products. No license, express, implied or otherwise, is granted under any patents, copyrights or other intellectual property rights of NEC or others.
- Descriptions of circuits, software and other related information in this document are provided for illustrative purposes in semiconductor product operation and application examples. The incorporation of these circuits, software and information in the design of customer's equipment shall be done under the full responsibility of customer. NEC assumes no responsibility for any losses incurred by customers or third parties arising from the use of these circuits, software and information.
- While NEC endeavours to enhance the quality, reliability and safety of NEC semiconductor products, customers agree and acknowledge that the possibility of defects thereof cannot be eliminated entirely. To minimize risks of damage to property or injury (including death) to persons arising from defects in NEC semiconductor products, customers must incorporate sufficient safety measures in their design, such as redundancy, fire-containment, and anti-failure features.
- NEC semiconductor products are classified into the following three quality grades:
"Standard", "Special" and "Specific". The "Specific" quality grade applies only to semiconductor products developed based on a customer-designated "quality assurance program" for a specific application. The recommended applications of a semiconductor product depend on its quality grade, as indicated below. Customers must check the quality grade of each semiconductor product before using it in a particular application.
"Standard": Computers, office equipment, communications equipment, test and measurement equipment, audio and visual equipment, home electronic appliances, machine tools, personal electronic equipment and industrial robots
"Special": Transportation equipment (automobiles, trains, ships, etc.), traffic control systems, anti-disaster systems, anti-crime systems, safety equipment and medical equipment (not specifically designed for life support)
"Specific": Aircraft, aerospace equipment, submersible repeaters, nuclear reactor control systems, life support systems and medical equipment for life support, etc.

The quality grade of NEC semiconductor products is "Standard" unless otherwise expressly specified in NEC's data sheets or data books, etc. If customers wish to use NEC semiconductor products in applications not intended by NEC, they must contact an NEC sales representative in advance to determine NEC's willingness to support a given application.

(Note)

(1) "NEC" as used in this statement means NEC Corporation and also includes its majority-owned subsidiaries.

(2) "NEC semiconductor products" means any semiconductor product developed or manufactured by or for NEC (as defined above).