

Transistors

2N6520

HIGH VOLTAGE TRANSISTOR

ABSOLUTE MAXIMUM RATINGS ($T_a = 25^\circ\text{C}$)

Characteristic	Symbol	Rating	Unit
Collector-Base Voltage	V_{CBO}	-350	V
Collector-Emitter Voltage	V_{CEO}	-350	V
Emitter-Base Voltage	V_{EBO}	-5	V
Collector Current	I_C	-500	mA
Base Current	I_B	-250	mA
Collector Dissipation	P_C	0.625	W
Derate above 25°C		5	mW/ $^\circ\text{C}$
Junction Temperature	T_j	150	$^\circ\text{C}$
Storage Temperature	T_{stg}	-55~150	$^\circ\text{C}$

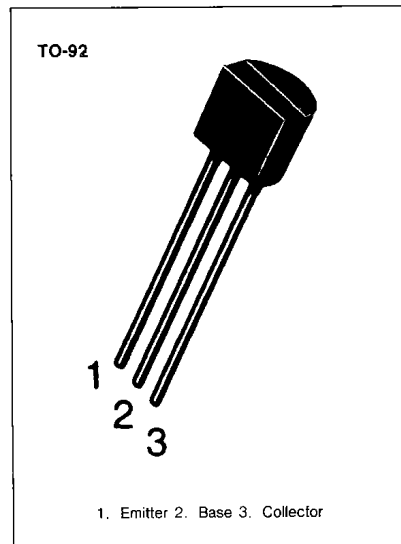

ELECTRICAL CHARACTERISTICS ($T_a = 25^\circ\text{C}$)

Characteristic	Symbol	Test Condition	Min	Max	Unit
Collector Base Breakdown Voltage	BV_{CBO}	$I_C = -100\mu\text{A}, I_E = 0$	-350		V
* Collector Emitter Breakdown Voltage	BV_{CEO}	$I_C = -1\text{mA}, I_B = 0$	-350		V
Emitter Base Breakdown Voltage	BV_{EBO}	$I_E = -10\mu\text{A}, I_C = 0$	-5		V
Collector Cutoff Current	I_{CBO}	$V_{CB} = -250\text{V}, I_E = 0$		-50	nA
Emitter Cutoff Current	I_{EBO}	$V_{EB} = -4\text{V}, I_C = 0$		-50	nA
* DC Current Gain	h_{FE}	$V_{CE} = -10\text{V}, I_C = -1\text{mA}$	20		
		$V_{CE} = -10\text{V}, I_C = -10\text{mA}$	30		
		$V_{CE} = -10\text{V}, I_C = -30\text{mA}$	30	200	
		$V_{CE} = -10\text{V}, I_C = -50\text{mA}$	20	200	
		$V_{CE} = -10\text{V}, I_C = -100\text{mA}$	15		
Collector-Emitter Saturation Voltage	$V_{CE}(\text{sat})$	$I_C = -10\text{mA}, I_B = -1\text{mA}$		-0.30	V
		$I_C = -20\text{mA}, I_B = -2\text{mA}$		-0.35	V
		$I_C = -30\text{mA}, I_B = -3\text{mA}$		-0.50	V
		$I_C = -50\text{mA}, I_B = -5\text{mA}$		-1	V
Base-Emitter Saturation Voltage	$V_{BE}(\text{sat})$	$I_C = -10\text{mA}, I_B = -1\text{mA}$		-0.75	V
		$I_C = -20\text{mA}, I_B = -2\text{mA}$		-0.85	V
		$I_C = -30\text{mA}, I_B = -3\text{mA}$		-0.90	V
Base Emitter On Voltage	$V_{BE}(\text{on})$	$V_{CE} = -10\text{V}, I_C = -100\text{mA}$		-2	V
* Current Gain Bandwidth Product	f_T	$V_{CE} = -20\text{V}, I_C = -10\text{mA}, f = 20\text{MHz}$	40	200	MHz
Collector Base Capacitance	C_{cb}	$V_{CB} = -20\text{V}, I_E = 0, f = 1\text{MHz}$		6	pF
Emitter Base Capacitance	C_{eb}	$V_{EB} = -0.5\text{V}, I_C = 0, f = 1\text{MHz}$		100	pF
Turn On Time	t_{on}	$V_{BE}(\text{off}) = -2\text{V}, V_{CC} = -100\text{V}$		200	ns
		$I_C = -50\text{mA}, I_B1 = -10\text{mA}$			
Turn Off Time	t_{off}	$V_{CC} = -100\text{V}, I_C = -50\text{mA}$		3.5	ns
		$I_B1 = I_B2 = -10\text{mA}$			

* Pulse Test: $PW = 300\mu\text{s}$, Duty Cycle = 2%



DC CURRENT GAIN

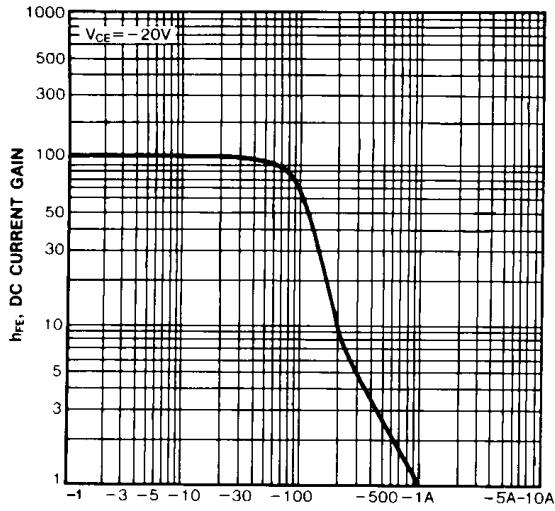

BASE-EMITTER SATURATION VOLTAGE COLLECTOR-EMITTER SATURATION VOLTAGE

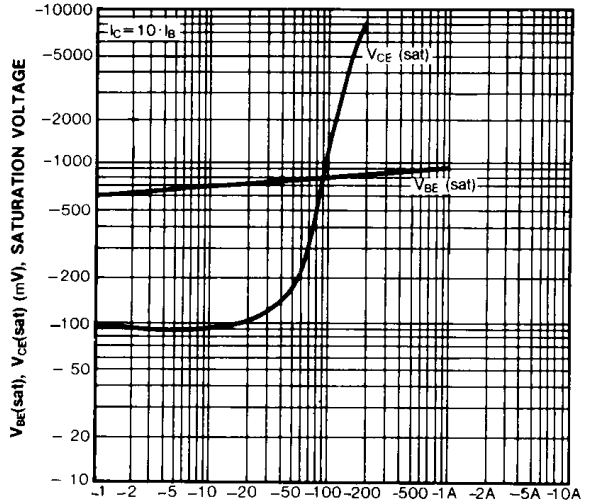

TURN-ON TIME

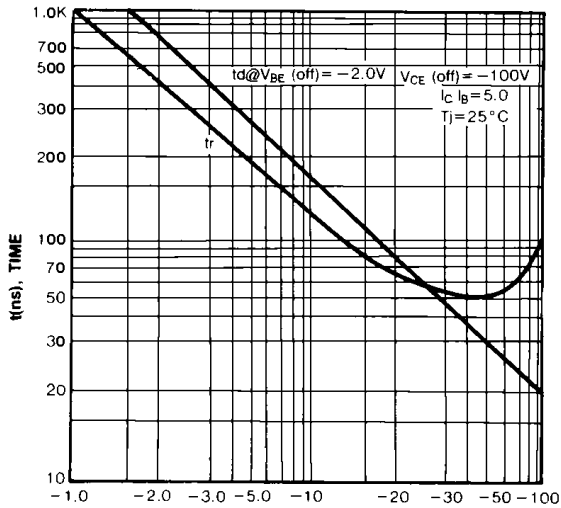

TEMPERATURE COEFFICIENTS

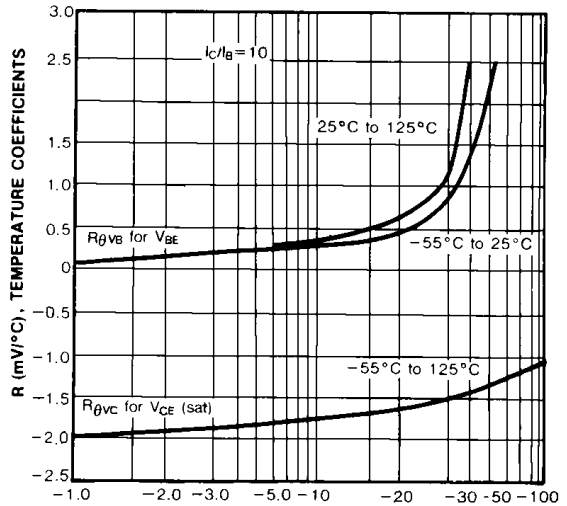

TURN-OFF TIME

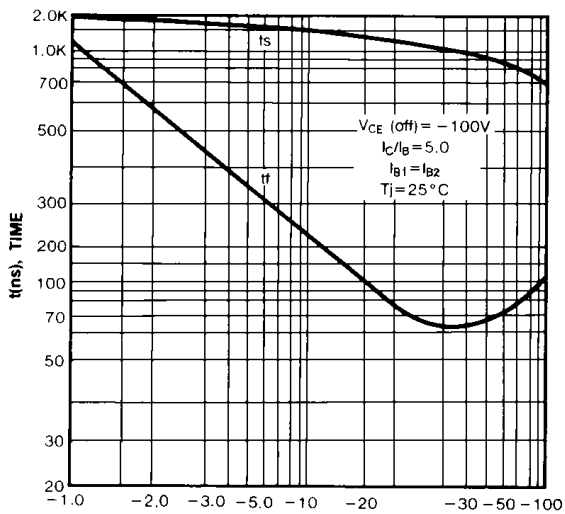

CURRENT-GAIN-BANDWIDTH PRODUCT

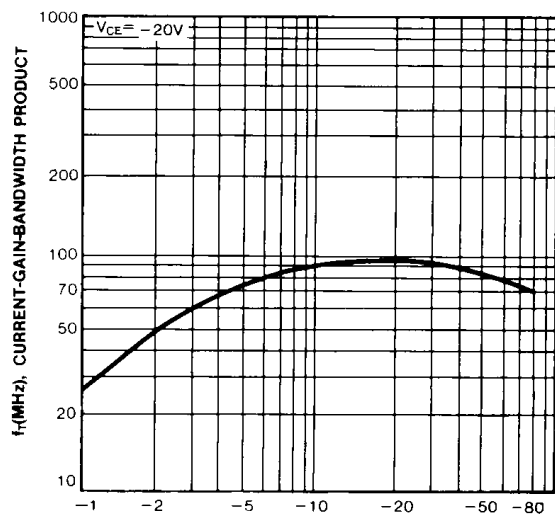

CAPACITANCE

