

**Major Ratings and Characteristics**

Characteristics	225CNQ015	Units
$I_{F(AV)}$ Rectangular waveform	220	A
$V_{RRM}$	15	V
$I_{FSM}$ @ tp=5 $\mu$ s sine	10,800	A
$V_F$ @ 110Apk, $T_J=75^\circ\text{C}$ (per leg)	0.32	V
$T_J$ range	-55 to 100	$^\circ\text{C}$

**Description/Features**

The 225CNQ015 high current, center tap Schottky modules have been optimized for ultra low forward voltage drop specifically for the OR'ing of parallel power supplies. The proprietary barrier technology allows for reliable operation up to 100° C junction temperature. Typical applications are in parallel switching power supplies, converters, reverse battery protection, and redundant power subsystems.

- 100° C  $T_J$  operation
- Center tap module
- Optimized for OR'ing applications
- High purity, high temperature epoxy encapsulation for enhanced mechanical strength and moisture resistance
- Ultra low forward voltage drop
- High frequency operation
- Guard ring enhanced ruggedness and long term reliability

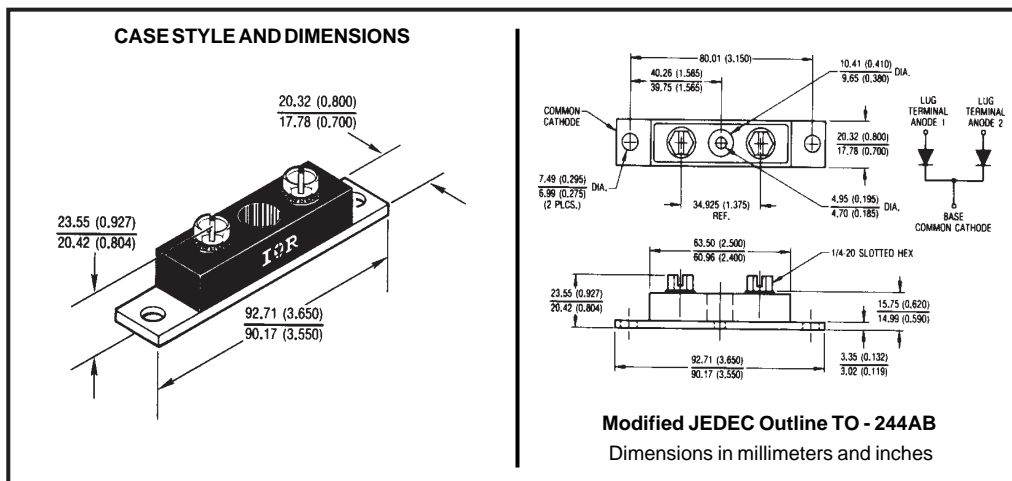

## Voltage Ratings

Part number	225CNQ015
$V_R$ Max. DC Reverse Voltage (V)	15
$V_{RWM}$ Max. Working Peak Reverse Voltage (V)	

## Absolute Maximum Ratings

Parameters	225CNQ	Units	Conditions
$I_{F(AV)}$ Max. Average Forward Current * See Fig. 5	220	A	50% duty cycle @ $T_C = 74^\circ\text{C}$ , rectangular waveform
$I_{FSM}$ Max. Peak One Cycle Non-Repetitive Surge Current (Per Leg) * See Fig. 7	10,800	A	Following any rated load condition and with rated $V_{RWM}$ applied
	1700		
$E_{AS}$ Non-Repetitive Avalanche Energy (Per Leg)	9	mJ	$T_J = 25^\circ\text{C}$ , $I_{AS} = 2$ Amps, $L = 4.5$ mH
$I_{AR}$ Repetitive Avalanche Current (Per Leg)	2	A	Current decaying linearly to zero in 1 $\mu\text{sec}$ Frequency limited by $T_J$ max. $V_A = 3.0 \times V_R$ typical

## Electrical Specifications

Parameters	225CNQ	Units	Conditions
$V_{FM}$ Max. Forward Voltage Drop (Per Leg) * See Fig. 1 (1)	0.38	V	@ 110A
	0.49	V	@ 220A
	0.32	V	@ 110A
	0.42	V	@ 220A
$I_{RM}$ Max. Reverse Leakage Current (Per Leg) * See Fig. 2 (1)	40	mA	$T_J = 25^\circ\text{C}$
	2000	mA	$T_J = 125^\circ\text{C}$
	1780	mA	$T_J = 100^\circ\text{C}$
	1080	mA	$T_J = 100^\circ\text{C}$
$C_T$ Max. Junction Capacitance (Per Leg)	7700	pF	$V_R = 5V_{DC}$ , (test signal range 100Khz to 1Mhz) $25^\circ\text{C}$
$L_S$ Typical Series Inductance (Per Leg)	7.0	nH	From top of terminal hole to mounting plane
$dv/dt$ Max. Voltage Rate of Change (Rated $V_R$ )	10,000	V/ $\mu\text{s}$	

(1) Pulse Width < 300 $\mu\text{s}$ , Duty Cycle < 2%

## Thermal-Mechanical Specifications

Parameters	225CNQ	Units	Conditions
$T_J$ Max. Junction Temperature Range	-55 to 100	$^\circ\text{C}$	
$T_{stg}$ Max. Storage Temperature Range	-55 to 100	$^\circ\text{C}$	
$R_{thJC}$ Max. Thermal Resistance Junction to Case (Per Leg)	0.40	$^\circ\text{C}/\text{W}$	DC operation * See Fig. 4
$R_{thJC}$ Max. Thermal Resistance Junction to Case (Per Package)	0.20	$^\circ\text{C}/\text{W}$	DC operation
$R_{thCS}$ Typical Thermal Resistance, Case to Heatsink	0.10	$^\circ\text{C}/\text{W}$	Mounting surface, smooth and greased
wt Approximate Weight	79 (2.80)	g (oz.)	
T Mounting Torque Base	Min.	40 (35)	Kg-cm (lbf-in)
	Max.	58 (50)	
Mounting Torque Center Hole	Typ.	17 (15)	
	Min.	58 (50)	
Terminal Torque	Min.	58 (50)	
	Max.	86 (75)	
Case Style	TO-244AB		Modified JEDEC

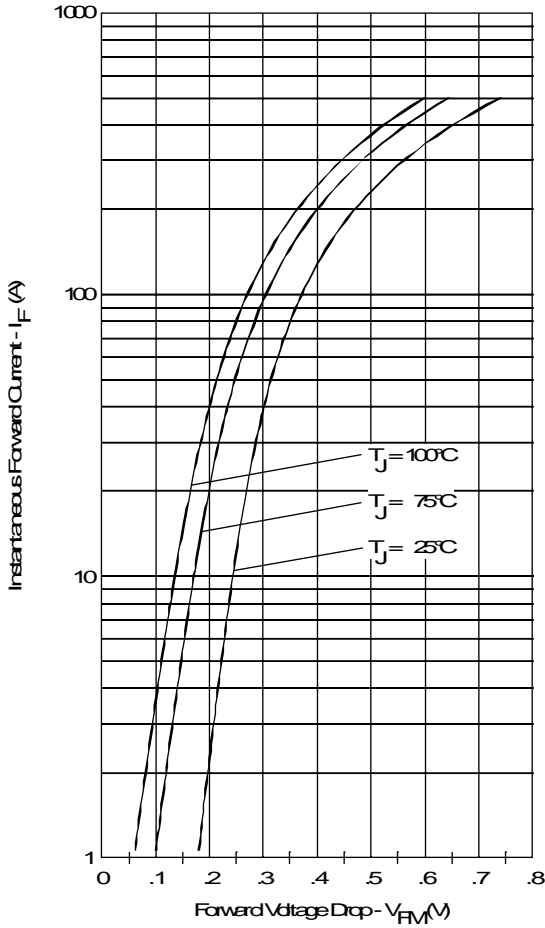

Fig. 1 - Max. Forward Voltage Drop Characteristics (Per Leg)

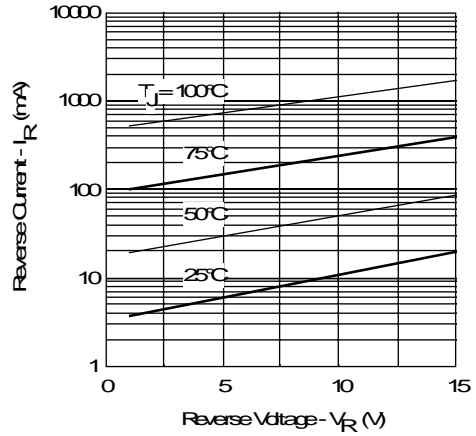

Fig. 2 - Typical Values Of Reverse Current Vs. Reverse Voltage (Per Leg)

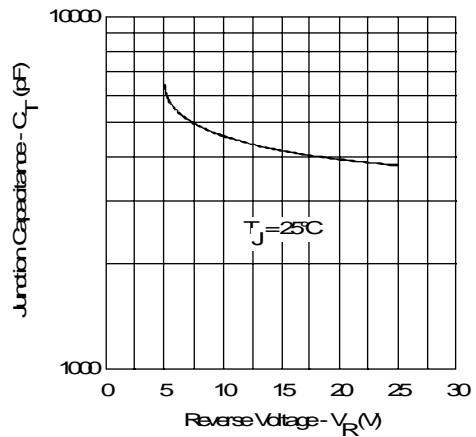

Fig. 3 - Typical Junction Capacitance Vs. Reverse Voltage (Per Leg)

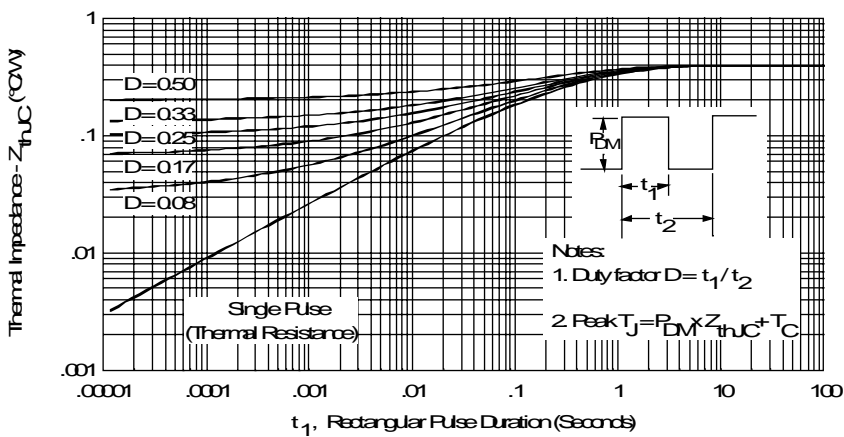

Fig. 4 - Max. Thermal Impedance  $Z_{thJC}$  Characteristics (Per Leg)

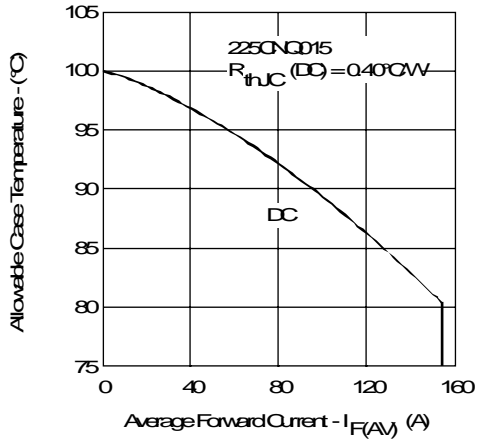

Fig. 5- Max. Allowable Case Temperature Vs. Average Forward Current (Per Leg)

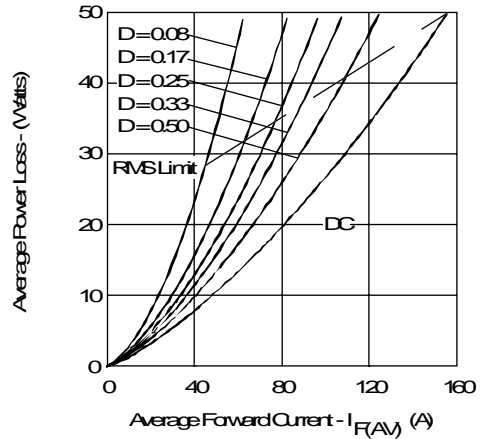

Fig. 6- Forward Power Loss Characteristics (Per Leg)

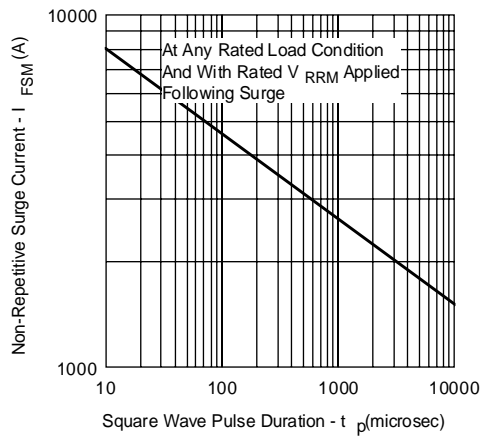

Fig. 7- Max. Non-Repetitive Surge Current (Per Leg)

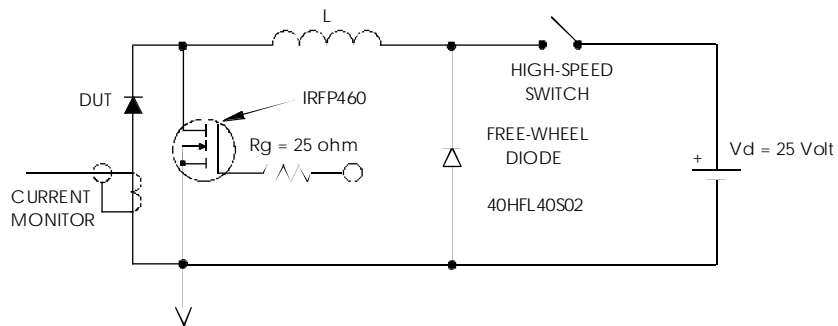

Fig. 8- Unclamped Inductive Test Circuit