



SOT-23 Plastic-Encapsulate Transistors

S9015LT1 TRANSISTOR (PNP)

FEATURES

Power dissipation

$$P_{CM} : 0.2 \text{ W (} T_{amb}=25 \text{)}$$

Collector current

$$I_{CM} : -0.1 \text{ A}$$

Collector-base voltage

$$V_{(BR)CBO} : -50 \text{ V}$$

Operating and storage junction temperature range

$$T_J, T_{stg}: -55 \text{ to } +150$$

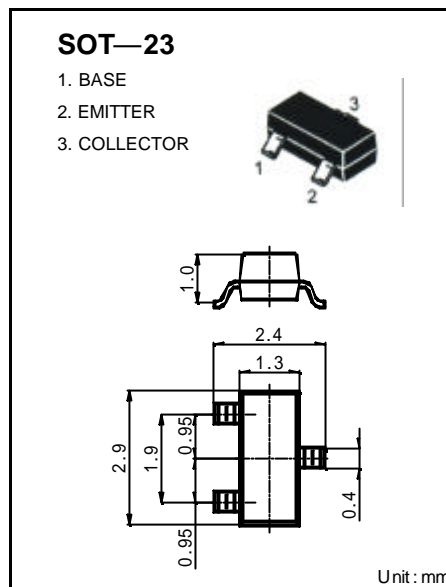

ELECTRICAL CHARACTERISTICS ($T_{amb}=25$ unless otherwise specified)

Parameter	Symbol	Test conditions	MIN	TYP	MAX	UNIT
Collector-base breakdown voltage	$V_{(BR)CBO}$	$I_C = -100 \mu A, I_E = 0$	-50			V
Collector-emitter breakdown voltage	$V_{(BR)CEO}$	$I_C = -0.1 mA, I_B = 0$	-45			V
Emitter-base breakdown voltage	$V_{(BR)EBO}$	$I_E = -100 \mu A, I_C = 0$	-5			V
Collector cut-off current	I_{CBO}	$V_{CB} = -50 V, I_E = 0$			-0.1	μA
Emitter cut-off current	I_{EBO}	$V_{EB} = -5 V, I_C = 0$			-0.1	μA
DC current gain	$H_{FE(1)}$	$V_{CE} = -5 V, I_C = -1 mA$	200		1000	
Collector-emitter saturation voltage	$V_{CE(sat)}$	$I_C = -100 mA, I_B = -10 mA$			-0.3	V
Base-emitter saturation voltage	$V_{BE(sat)}$	$I_C = -100 mA, I_B = -10 mA$			-1	V
Transition frequency	f_T	$V_{CE} = -5 V, I_C = -10 mA$ $f = 30 MHz$	150			MHz

CLASSIFICATION OF $H_{FE(1)}$

Rank	L	H
Range	200-450	450-1000

DEVICE MARKING : S9015LT1=M6

SOT-23 PACKAGE OUTLINE DIMENSIONS

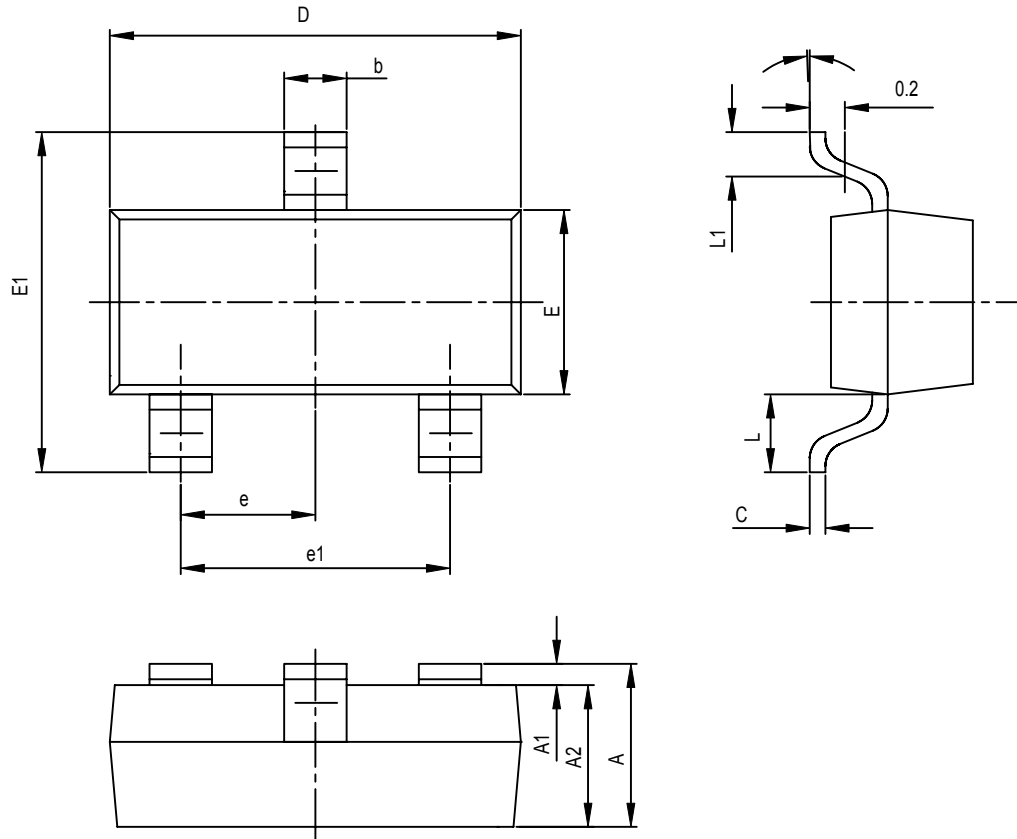

Symbol	Dimensions In Millimeters		Dimensions In Inches	
	Min	Max	Min	Max
A	0.900	1.100	0.035	0.043
A1	0.000	0.100	0.000	0.004
A2	0.900	1.000	0.035	0.039
b	0.300	0.500	0.012	0.020
c	0.080	0.150	0.003	0.006
D	2.800	3.000	0.110	0.118
E	1.200	1.400	0.047	0.055
E1	2.250	2.550	0.089	0.100
e	0.950TPY		0.037TPY	
e1	1.800	2.000	0.071	0.079
L	0.550REF		0.022REF	
L1	0.300	0.500	0.012	0.020
θ	0°	8°	0°	8°