

Features

- Fast Switching Speed
- Ultra-Small Surface Mount Package
- For General Purpose Switching Applications
- High Conductance
- Lead Free/RoHS Compliant (Note 3)**

Mechanical Data

- Case: SOD-323
- Case Material: Molded Plastic. UL Flammability Classification Rating 94V-0
- Moisture Sensitivity: Level 1 per J-STD-020C
- Leads: Solderable per MIL-STD-202, Method 208
- Lead Free Plating (Matte Tin Finish annealed over Alloy 42 leadframe).
- Polarity: Cathode Band
- Marking: T5
- Weight: 0.004 grams (approximate)

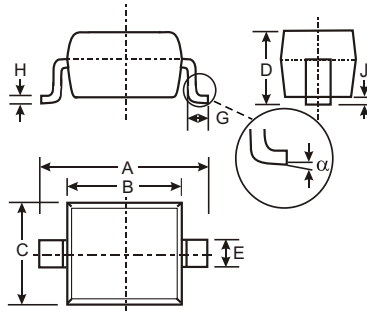

SOD-323		
Dim	Min	Max
A	2.30	2.70
B	1.60	1.80
C	1.20	1.40
D	1.05 Typical	
E	0.25	0.35
G	0.20	0.40
H	0.10	0.15
J	0.05 Typical	
	0	8
All Dimensions in mm		

Maximum Ratings @ T_A = 25 C unless otherwise specified

Characteristic	Symbol	Value	Unit
Non-Repetitive Peak Reverse Voltage	V _{RM}	100	V
Peak Repetitive Reverse Voltage Working Peak Reverse Voltage DC Blocking Voltage	V _{RRM} V _{RWM} V _R	80	V
RMS Reverse Voltage	V _{R(RMS)}	57	V
Forward Continuous Current	I _{FM}	500	mA
Average Rectified Output Current	I _O	250	mA
Non-Repetitive Peak Forward Surge Current @ t = 1.0 s @ t = 1.0s	I _{FSM}	4.0 2.0	A
Power Dissipation (Note 2)	P _d	200	mW
Thermal Resistance Junction to Ambient Air (Note 2)	R _{JA}	625	C/W
Operating and Storage Temperature Range	T _j , T _{STG}	-65 to +150	C

Electrical Characteristics @ T_A = 25 C unless otherwise specified

Characteristic	Symbol	Min	Max	Unit	Test Condition
Reverse Breakdown Voltage (Note 1)	V _{BR(R)}	80		V	I _R = 100 A
Forward Voltage	V _{FM}	0.62	0.72 0.855 1.0 1.25	V	I _F = 5.0mA I _F = 10mA I _F = 100mA I _F = 150mA
Peak Reverse Current (Note 1)	I _{RM}		100 50 30 25	nA A A nA	V _R = 80V V _R = 75V, T _j = 150 C V _R = 25V, T _j = 150 C V _R = 20V
Total Capacitance	C _T		3.5	pF	V _R = 0, f = 1.0MHz
Reverse Recovery Time	t _{rr}		4.0	ns	I _F = I _R = 10mA, I _{rr} = 0.1 x I _R , R _L = 100

- Notes:
1. Short duration test pulse used to minimize self-heating.
 2. Part mounted on FR-4 PC board with recommended pad layout, which can be found on our website at <http://www.diodes.com/datasheets/ap02001.pdf>.
 3. No purposefully added lead.

Ordering Information (Note 4)

Device	Packaging	Shipping
1N4448HWS-7-F	SOD-323	3000/Tape & Reel

Notes: 4. For Packaging Details, go to our website at <http://www.diodes.com/datasheets/ap02007.pdf>.

Marking Information

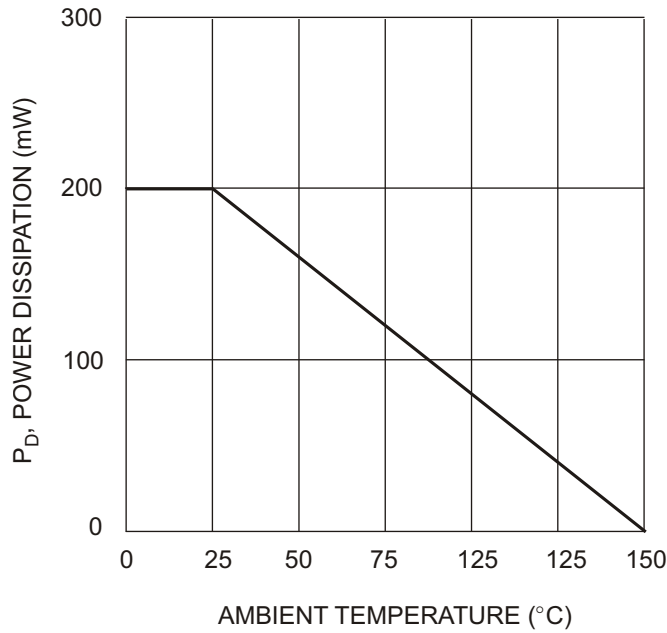
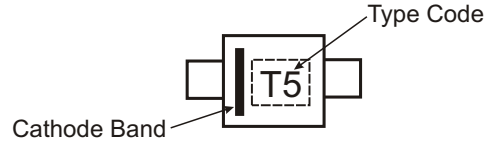

Fig. 1 Forward Current Derating Curve

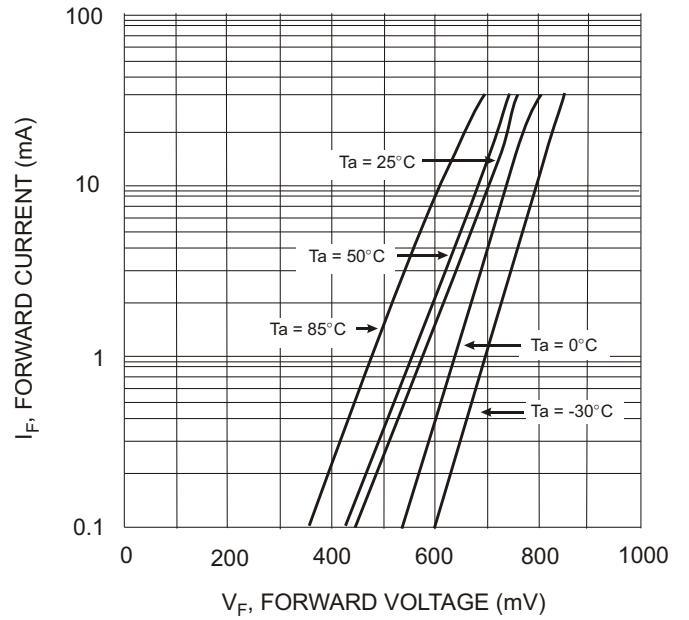

Fig. 2 Typical Forward Characteristics

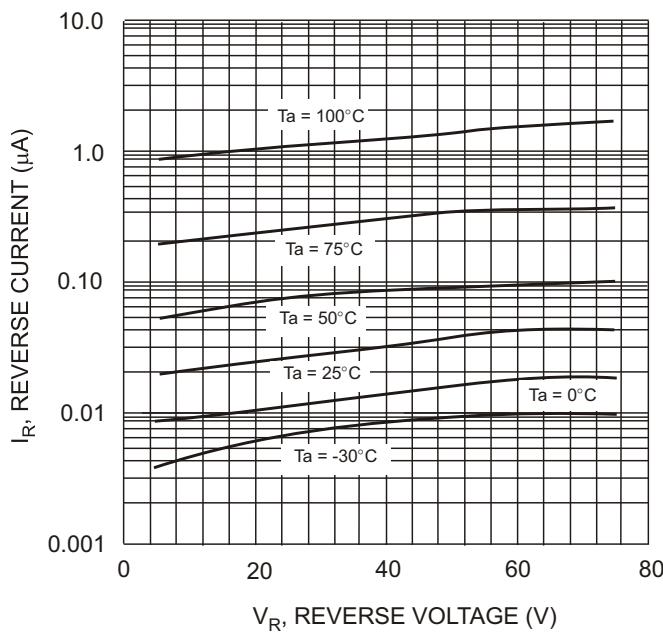

Fig. 3 Typical Reverse Characteristics

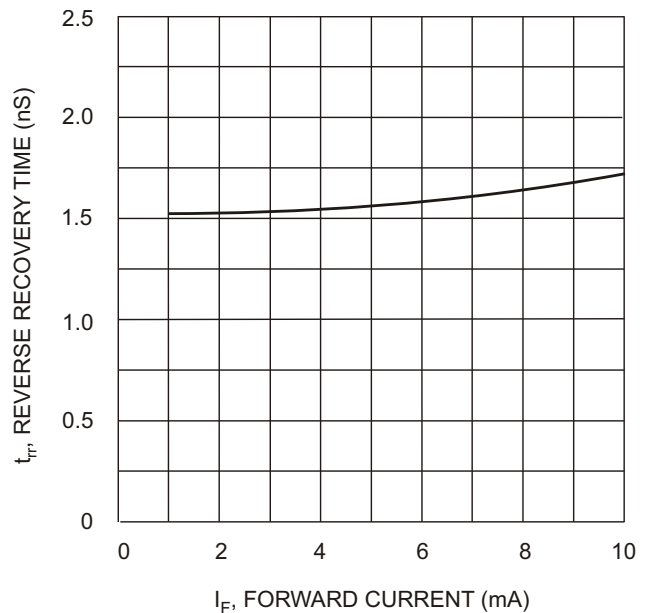

Fig. 4 Reverse Recovery Time vs. Forward Current

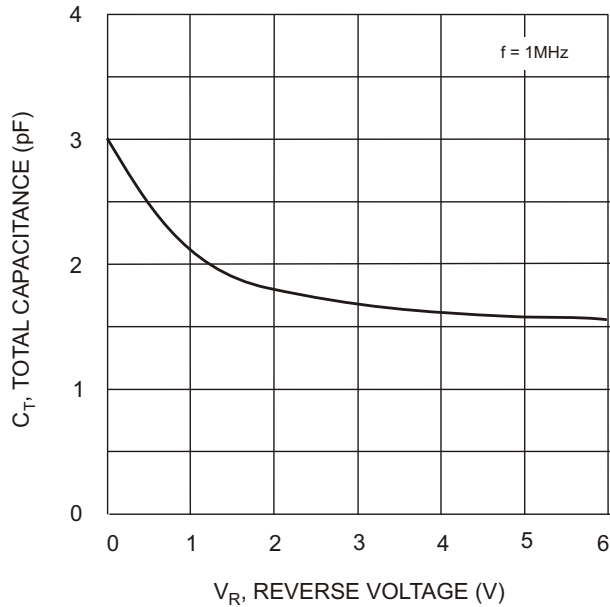

Fig. 5 Total Capacitance vs.
Reverse Voltage

IMPORTANT NOTICE

Diodes Incorporated and its subsidiaries reserve the right to make modifications, enhancements, improvements, corrections or other changes without further notice to any product herein. Diodes Incorporated does not assume any liability arising out of the application or use of any product described herein; neither does it convey any license under its patent rights, nor the rights of others. The user of products in such applications shall assume all risks of such use and will agree to hold Diodes Incorporated and all the companies whose products are represented on our website, harmless against all damages.

LIFE SUPPORT

Diodes Incorporated products are not authorized for use as critical components in life support devices or systems without the expressed written approval of the President of Diodes Incorporated.