

# International IR Rectifier

## 10BQ030

### SCHOTTKY RECTIFIER

1 Amp

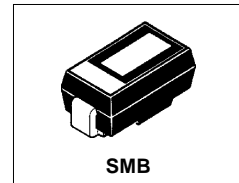

#### Major Ratings and Characteristics

| Characteristics                          | 10BQ030     | Units            |
|--|-------------|------------------|
| $I_{F(AV)}$ Rectangular waveform         | 1.0         | A                |
| $V_{RRM}$                                | 30          | V                |
| $I_{FSM}$ @ $t_p=5$ ms sine              | 430         | A                |
| $V_F$ @ 1.0A pk, $T_J=125^\circ\text{C}$ | 0.30        | V                |
| $T_J$ range                              | - 55 to 150 | $^\circ\text{C}$ |

#### Description/ Features

The 10BQ030 surface-mount Schottky rectifier has been designed for applications requiring low forward drop and small foot prints on PC boards. Typical applications are in disk drives, switching power supplies, converters, free-wheeling diodes, battery charging, and reverse battery protection.

- Small foot print, surface mountable
- Very low forward voltage drop
- High frequency operation
- Guard ring for enhanced ruggedness and long term reliability

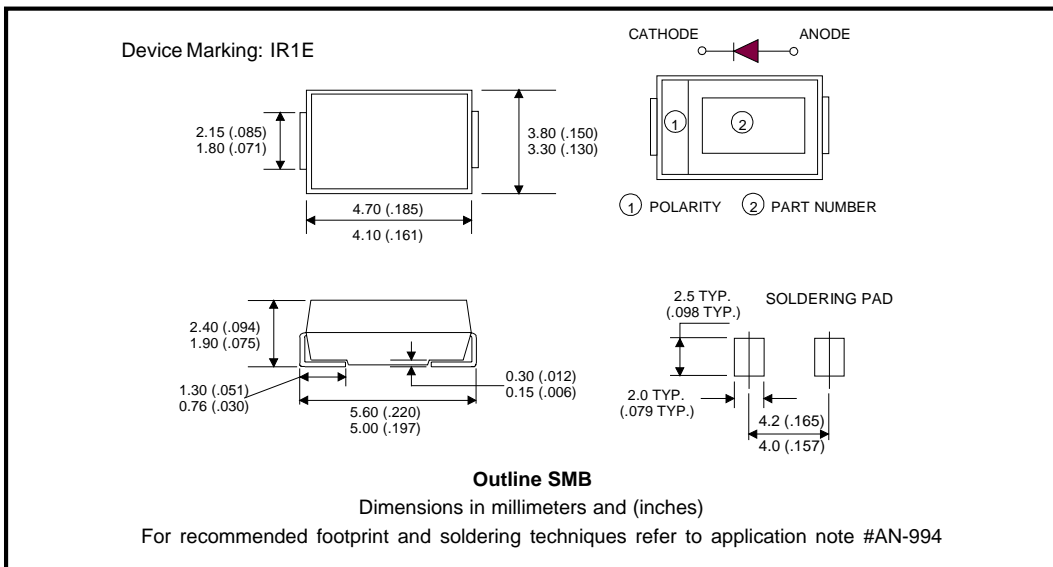

## Voltage Ratings

| Part number                                     | 10BQ030 |
|---|---------|
| $V_R$ Max. DC Reverse Voltage (V)               | 30      |
| $V_{RWM}$ Max. Working Peak Reverse Voltage (V) |         |

## Absolute Maximum Ratings

| Parameters  | 10BQ | Units | Conditions   |
|---|------|-------|--|
| $I_{F(AV)}$ Max. Average Forward Current                                | 1.0  | A     | 50% duty cycle @ $T_L = 106^\circ\text{C}$ , rectangular wave form.  |
| $I_{FSM}$ Max. Peak One Cycle Non-Repetitive Surge Current * See Fig. 6 | 430  |       | 5 $\mu\text{s}$ Sine or 3 $\mu\text{s}$ Rect. pulse  |
|   | 90   |       | 10ms Sine or 6ms Rect. pulse   |
| $E_{AS}$ Non-Repetitive Avalanche Energy                                | 3.0  | mJ    | $T_J = 25^\circ\text{C}$ , $I_{AS} = 1\text{A}$ , $L = 6\text{mH}$   |
| $I_{AR}$ Repetitive Avalanche Current                                   | 1.0  | A     | Current decaying linearly to zero in 1 $\mu\text{sec}$<br>Frequency limited by $T_J$ max. $V_a = 1.5 \times V_r$ typical |

## Electrical Specifications

| Parameters   | 10BQ  | Units            | Conditions  |
|--|-------|------------------|---|
| $V_{FM}$ Max. Forward Voltage Drop (1)             | 0.420 | V                | @ 1A  |
|  | 0.470 | V                | @ 2A  |
| $V_{FM}$ Max. Forward Voltage Drop (1)             | 0.300 | V                | @ 1A  |
|  | 0.370 | V                | @ 2A  |
| $I_{RM}$ Max. Reverse Leakage Current (1)          | 0.5   | mA               | $T_J = 25^\circ\text{C}$  |
|  | 5.0   | mA               | $T_J = 100^\circ\text{C}$   |
|  | 15    | mA               | $T_J = 125^\circ\text{C}$   |
| $C_T$ Max. Junction Capacitance                    | 200   | pF               | $V_R = 5V_{DC}$ , (test signal range 100KHz to 1Mhz) $25^\circ\text{C}$ |
| $L_S$ Typical Series Inductance                    | 2.0   | nH               | Measured lead to lead 5mm from package body                             |
| $dv/dt$ Max. Voltage Rate of Change (Rated $V_R$ ) | 10000 | V/ $\mu\text{s}$ |   |

(1) Pulse Width < 300 $\mu\text{s}$ , Duty Cycle < 2%

## Thermal-Mechanical Specifications

| Parameters   | 10BQ        | Units                     | Conditions       |
|--|-------------|---------------------------|------------------|
| $T_J$ Max. Junction Temperature Range (*)                | -55 to 150  | $^\circ\text{C}$          |                  |
| $T_{stg}$ Max. Storage Temperature Range                 | -55 to 150  | $^\circ\text{C}$          |                  |
| $R_{thJL}$ Max. Thermal Resistance Junction to Lead (**) | 25          | $^\circ\text{C}/\text{W}$ | DC operation     |
| $R_{thJA}$ Max. Thermal Resistance Junction to Ambient   | 80          | $^\circ\text{C}/\text{W}$ |                  |
| wt Approximate Weight                                    | 0.10(0.003) | g(oz.)                    |                  |
| Case Style   | SMB         |                           | Similar DO-214AA |
| Device Marking   | IR1E        |                           |                  |

(\*)  $\frac{dP_{tot}}{dT_j} < \frac{1}{R_{th(j-a)}}$  thermal runaway condition for a diode on its own heatsink

(\*\*) Mounted 1 inch square PCB

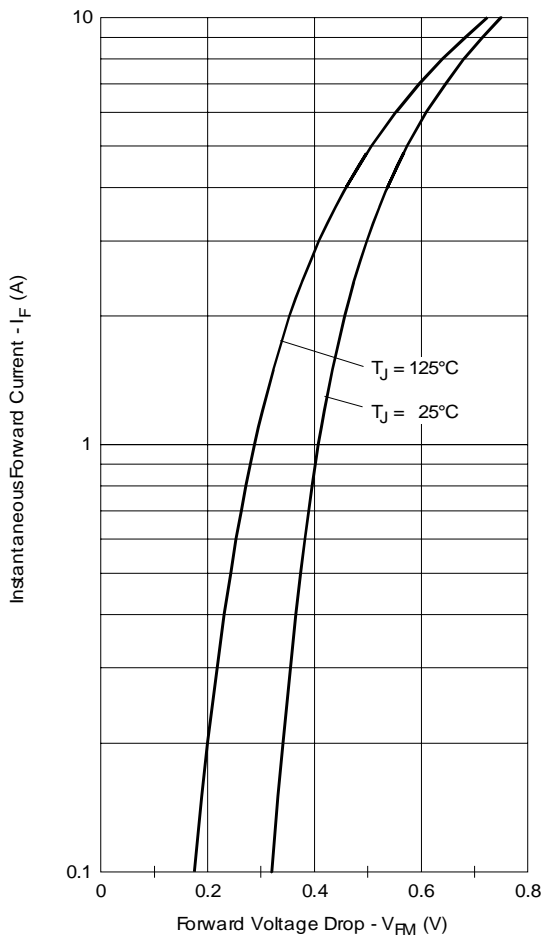

Fig. 1 - Maximum Forward Voltage Drop Characteristics

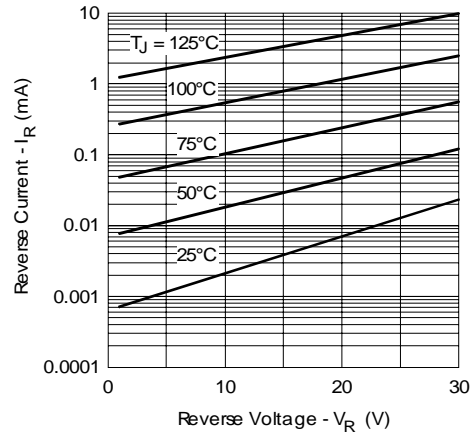

Fig. 2 - Typical Peak Reverse Current Vs. Reverse Voltage

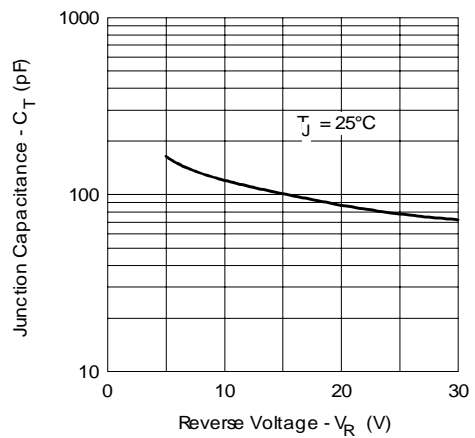

Fig. 3 - Typical Junction Capacitance Vs. Reverse Voltage

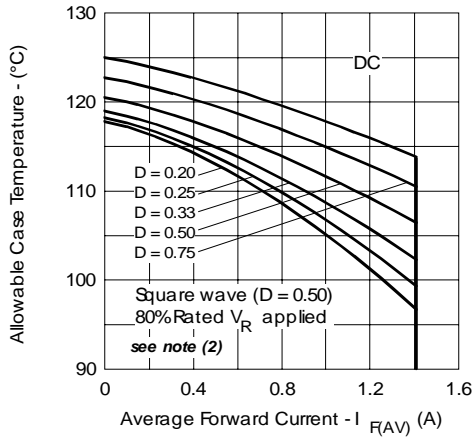

Fig. 4 - Maximum Average Forward Current Vs. Allowable Lead Temperature

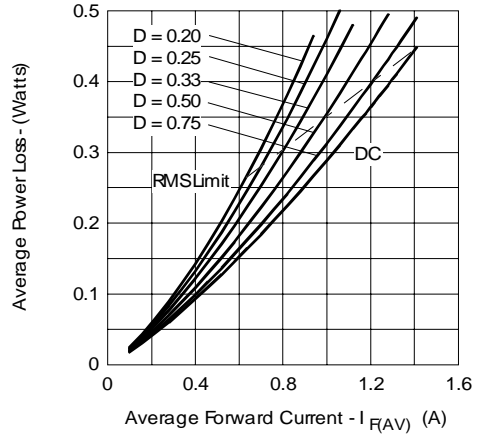

Fig. 5 - Maximum Average Forward Dissipation Vs. Average Forward Current

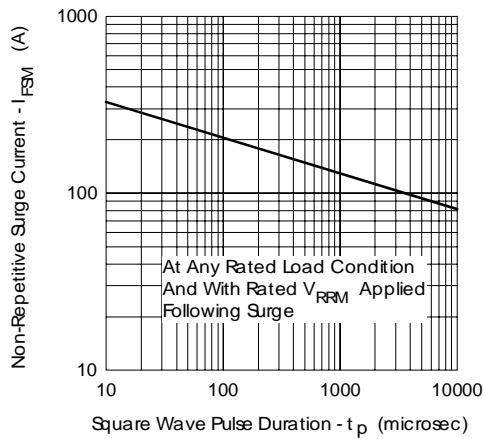
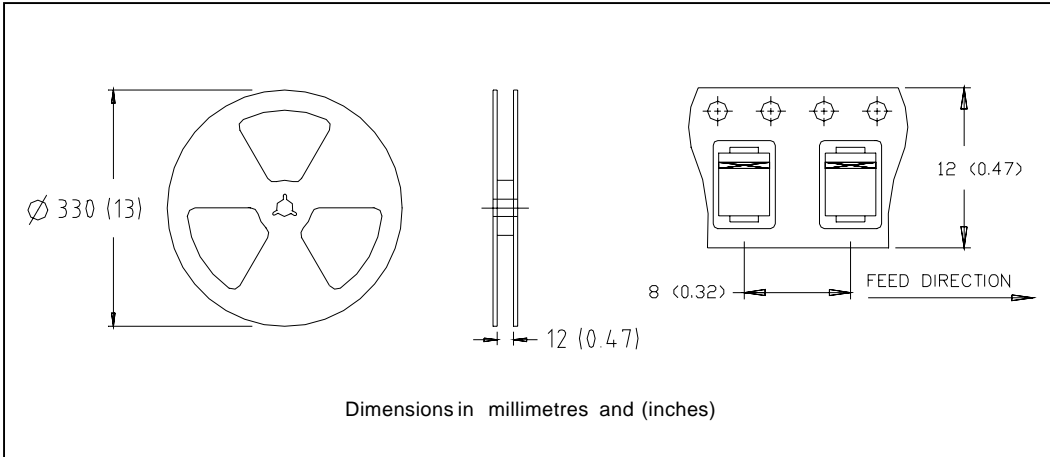

Fig. 6 - Maximum Peak Surge Forward Current Vs. Pulse Duration

- (2) Formula used:  $T_C = T_J - (Pd + Pd_{REV}) \times R_{thJC}$ ;  
 $Pd$  = Forward Power Loss =  $I_{F(AV)} \times V_{FM} @ (I_{F(AV)} / D)$  (see Fig. 6);  
 $Pd_{REV}$  = Inverse Power Loss =  $V_{R1} \times I_R (1 - D)$ ;  $I_R @ V_{R1} = 80\%$  rated  $V_R$

**Tape & Reel Information**



**Marking & Identification**

Each device has 2 rows for identification. The first row designates the device as manufactured by International Rectifier as indicated by the letters "IR", and the Part Number (indicates the current and the voltage rating). The second row indicates the year, the week of manufacturing and the Site ID.

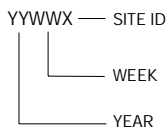
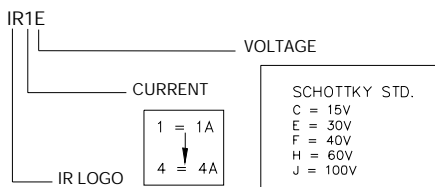

**Ordering Information**

**10BQ SERIES - TAPE AND REEL**

WHEN ORDERING, INDICATE THE PART NUMBER AND THE QUANTITY ( IN MULTIPLES OF 3000 PIECES).

EXAMPLE: 10BQ030TR - 6000 PIECES

**10BQ SERIES - BULK QUANTITIES**

WHEN ORDERING, INDICATE THE PART NUMBER AND THE QUANTITY ( IN MULTIPLES OF 1000 PIECES).

EXAMPLE: 10BQ030 - 2000 PIECES

10BQ030

Bulletin PD-20708 rev. F 03/03

International  
**IOR** Rectifier

---

Data and specifications subject to change without notice.  
This product has been designed and qualified for Industrial Level.  
Qualification Standards can be found on IR's Web site.

International  
**IOR** Rectifier

**IR WORLD HEADQUARTERS:** 233 Kansas St., El Segundo, California 90245, USA Tel: (310) 252-7105  
TAC Fax: (310) 252-7309  
Visit us at [www.irf.com](http://www.irf.com) for sales contact information. 03/03