



**ATTENTION**  
OBSERVE PRECAUTIONS  
FOR HANDLING  
ELECTROSTATIC  
DISCHARGE  
SENSITIVE  
DEVICES

## 105LB7D

### ➤ Features

- Single color
- High bright output
- Low power consumption
- High reliability and long life

### ➤ Descriptions:

- Dice material:
- Emitting Color:  
Super Bright Blue
- Device Outline:  
φ 10mm Round Type
- Lens Type:  
Blue diffused

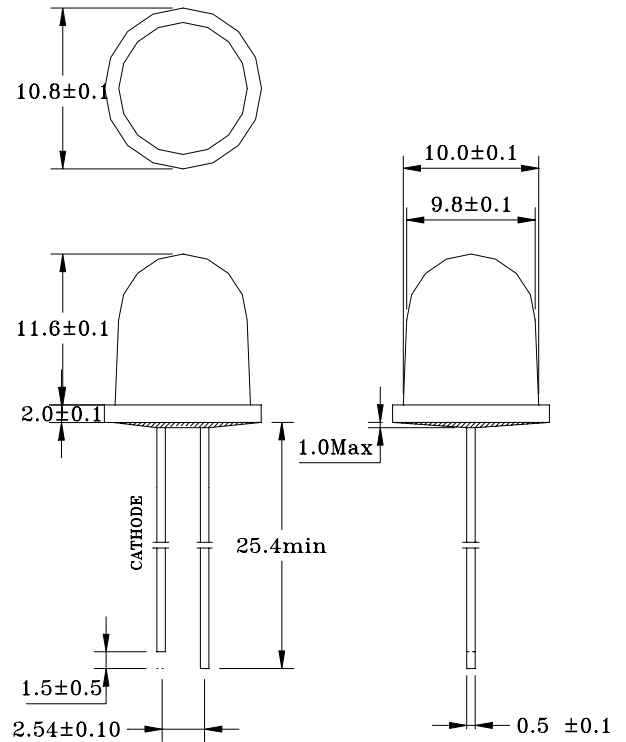

1. All dimensions are millimeters
2. Tolerance is  $\pm 0.25 \text{ mm}$  unless otherwise noted

### ➤ Directivity:

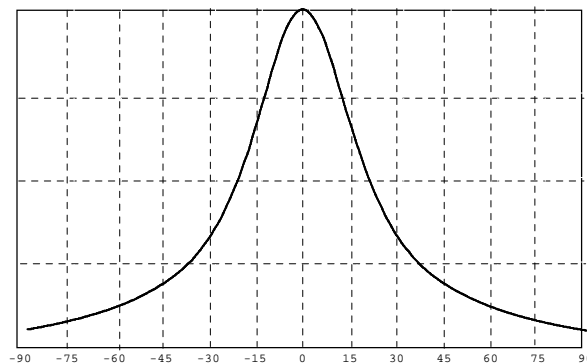



# LED SPECIFICATION

## Absolute maximum ratings (Ta = 25°C)

| Parameter             | Symbol            | Test Condition         | Value |      | Unit |
|-----------------------|-------------------|------------------------|-------|------|------|
|                       |                   |                        | Min.  | Max. |      |
| Reverse Voltage       | V <sub>R</sub>    | I <sub>R</sub> = 30 μA | 5     | --   | V    |
| Forward Current       | I <sub>F</sub>    | ----                   | ----  | 30   | mA   |
| Power Dissipation     | P <sub>d</sub>    | ----                   | ----  | 105  | mW   |
| Pulse Current         | I <sub>peak</sub> | Duty=0.1mS, 1kHz       | ----  | 100  | mA   |
| Operating Temperature | T <sub>opr</sub>  | ----                   | -20   | +85  | °C   |
| Storage Temperature   | T <sub>str</sub>  | ----                   | -25   | +100 | °C   |

## Electrical and optical characteristics (Ta = 25°C)

| Parameter                | Symbol         | Test Condition        | Value |       |         | Unit |
|--------------------------|----------------|-----------------------|-------|-------|---------|------|
|                          |                |                       | Min.  | Typ.  | Max.    |      |
| Forward Voltage          | V <sub>F</sub> | I <sub>F</sub> = 20mA |       | V7~V9 |         |      |
| Reverse Current          | I <sub>R</sub> | V <sub>R</sub> = 5V   | ----  | ----  | 30 μA   |      |
| Dominate Wavelength      | λ <sub>d</sub> | I <sub>F</sub> = 20mA |       | B4~B6 |         |      |
| Spectral Line half-width | Δλ             | I <sub>F</sub> = 20mA | ----  | 22    | nm      |      |
| Luminous Intensity       | I <sub>V</sub> | I <sub>F</sub> = 20mA |       | P,Q   |         |      |
| Viewing Angle            | 2θ 1/2         | I <sub>F</sub> = 20mA | 40    |       | 50 Deg. |      |



# BIN ranking for LEDs

## BRIGHTNESS BIN

| Bin Code | IV(mcd)   | Bin Code | IV(mcd)   | Bin Code | IV(mcd)   | Bin Code | IV(mcd)    |
|----------|-----------|----------|-----------|----------|-----------|----------|------------|
| A        | 0-5.0     | H        | 37.2-52.0 | Q        | 390-550   | X        | 4180--5860 |
| B        | 5.0-7.0   | J        | 52.0-72.8 | R        | 550-770   | Y        | 5860-8200  |
| C        | 7.0-9.8   | K        | 72.8-102  | S        | 770-1100  | Z1       | 8-10cd     |
| D        | 9.8-13.7  | L        | 102-145   | T        | 1100-1520 | Z2       | 10-12cd    |
| E        | 13.7-19.0 | M        | 145-200   | U        | 1520-2130 | Z3       | 12-14cd    |
| F        | 19.0-26.6 | N        | 200-280   | V        | 2130-3000 | Z4       | 14-16cd    |
| G        | 26.6-37.2 | P        | 280-390   | W        | 3000-4180 | Z5       | 16-18cd    |

## WAVELENGTH BIN

| Ligth Col. | Bin Code | Wavel. (nm) | Ligth Col.    | Bin Code | Wavel. (nm) |
|------------|----------|-------------|---------------|----------|-------------|
| BLUE       | B1       | 450-455     | YELLOW GREEN  | YG1      | 555-558     |
|            | B2       | 455-460     |               | YG2      | 558-561     |
|            | B3       | 460-465     |               | YG3      | 561-564     |
|            | B4       | 465-470     |               | YG4      | 564-567     |
|            | B5       | 470-475     |               | YG5      | 567-570     |
|            | B6       | 475-480     |               | YG6      | 570-573     |
| BLUE GREEN | G1       | 491-494     |               | YG7      | 573-576     |
|            | G2       | 494-497     | YELLOW        | Y1       | 582-585     |
|            | G3       | 497-500     |               | Y2       | 585-588     |
|            | G4       | 500-503     |               | Y3       | 588-591     |
|            | G5       | 503-506     |               | Y4       | 591-594     |
|            | G6       | 506-509     |               | Y5       | 594-597     |
|            | G7       | 509-512     | YELLOW ORANGE | YO1      | 597-600     |
|            | G8       | 512-515     |               | YO2      | 600-603     |
| PURE GREEN | G9       | 515-518     | YO3           | 603-606  |             |
|            | G10      | 518-521     | YO4           | 606-609  |             |
|            | G11      | 521-524     | PURE ORANGE   | O1       | 609-612     |
|            | G12      | 524-527     |               | O2       | 612-615     |
|            | G13      | 527-530     |               | O3       | 615-618     |
|            | G14      | 530-533     | RED           | R1       | 618-621     |
|            | G15      | 533-536     |               | R2       | 621-624     |
|            | G16      | 536-539     |               | R3       | 624-627     |
|            | G17      | 539-542     |               | R4       | 627-630     |
|            | G18      | 542-545     |               | R5       | 630-633     |
|            | G19      | 545-548     |               | R6       | 633-636     |

## FORWARD VOLTAGE (VF) BIN

| Bin Code | VF (V)  | Bin Code | VF (V)  | Bin Code | VF (V)  | Bin Code | VF (V)  |
|----------|---------|----------|---------|----------|---------|----------|---------|
| V1       | 1.6-1.8 | V5       | 2.4-2.6 | V9       | 3.2-3.4 | V13      | 4.0-4.2 |
| V2       | 1.8-2.0 | V6       | 2.6-2.8 | V10      | 3.4-3.6 | V14      | 4.2-4.4 |
| V3       | 2.0-2.2 | V7       | 2.8-3.0 | V11      | 3.6-3.8 | V15      | 4.4-4.6 |
| V4       | 2.2-2.4 | V8       | 3.0-3.2 | V12      | 3.8-4.0 | V16      | 4.6-4.8 |



# LED SPECIFICATION

## Typical electrical/optical characteristic curves:

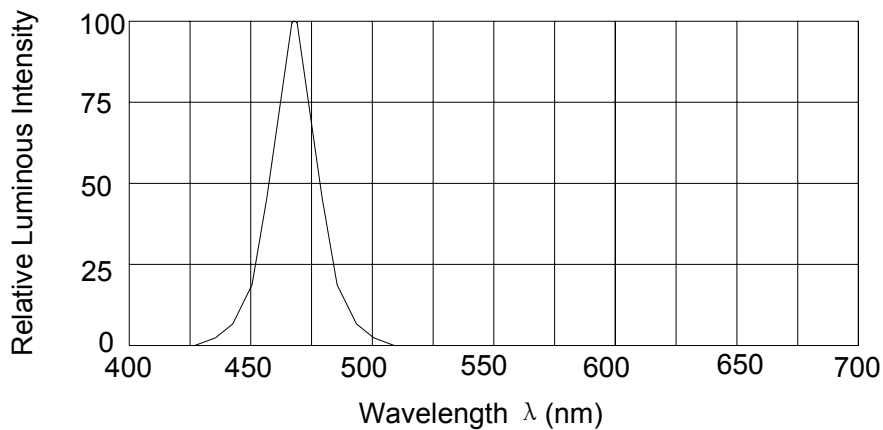
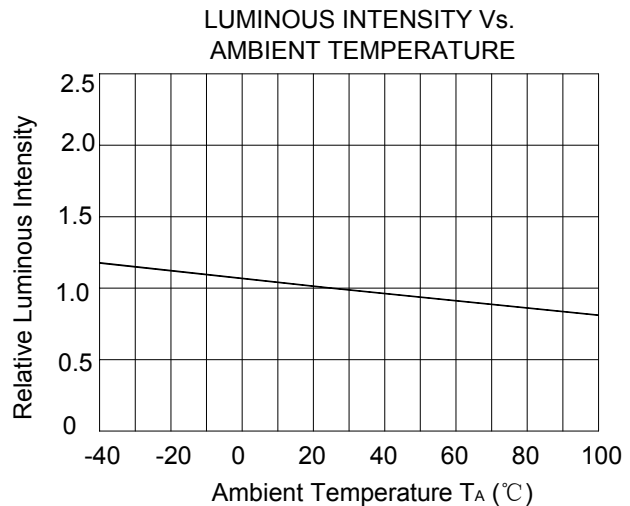
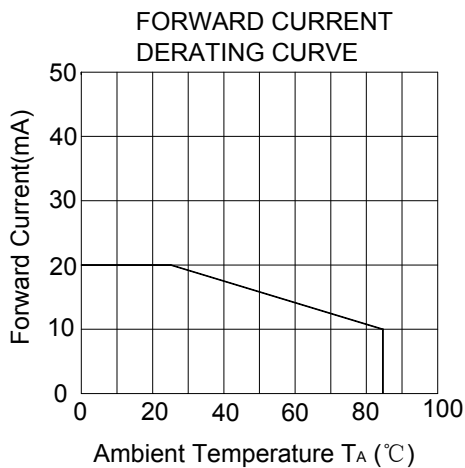
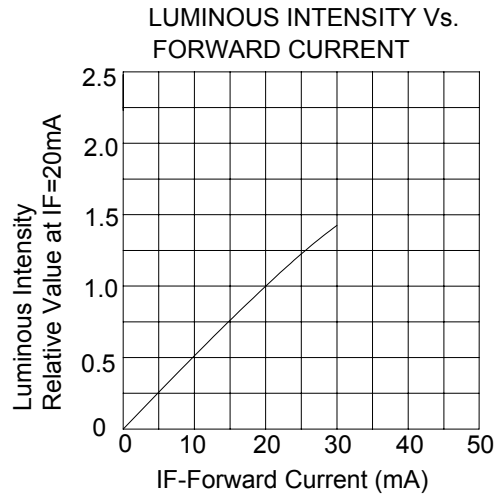
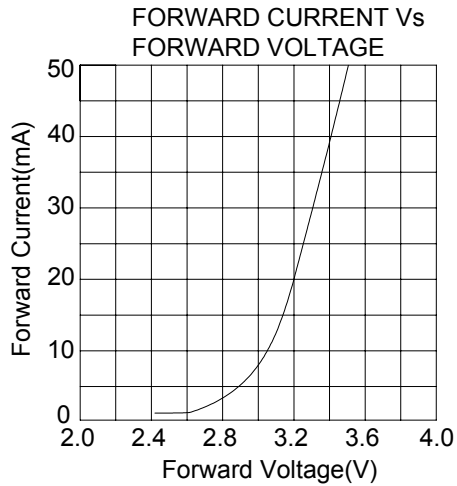



# LED LAMP APPLICATION

## •SOLDERING

| METHOD         | SOLDERING CONDITIONS  | REMARK  |
|----------------|---|---|
| DIP SOLDERING  | Bath temperature: $260 \pm 5^\circ\text{C}$<br>Immersion time: with 5 sec   | <ul style="list-style-type: none"> <li>Solder no closer than 3mm from the base of the package</li> <li>Using soldering flux, "RESIN FLUX" is recommended.</li> </ul>  |
| SOLDERING IRON | Soldering iron: 30W or smaller<br>Temperature at tip of iron: $260^\circ\text{C}$ or lower<br>Soldering time: within 5 sec. | <ul style="list-style-type: none"> <li>During soldering, take care not to press the tip of iron against the lead.</li> </ul> (To prevent heat from being transferred directly to the lead, hold the lead with a pair of tweezers while soldering) |

1) When soldering the lead of LED in a condition that the package is fixed with a panel (See Fig.1), be careful not to stress the leads with iron tip.

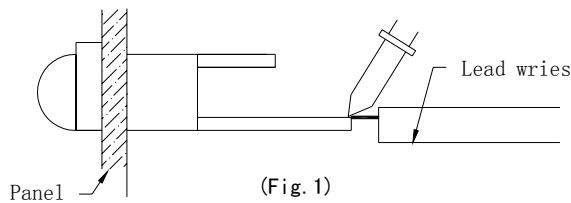

2) When soldering wire to the lead, work with a Fig (See Fig.2) to avoid stressing the package.

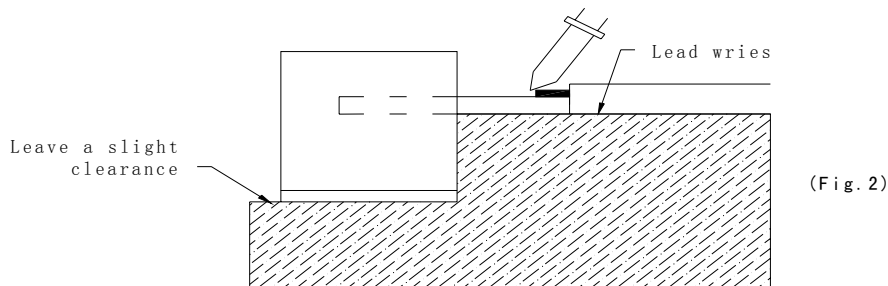

- 3) Similarly, when a jig is used to solder the LED to PC board, take care as much as possible to avoid steering the leads (See Fig.3).



- 4) Repositioning after soldering should be avoided as much as possible. If inevitable, be sure to preserve the soldering conditions with irons stated above: select a best-suited method that assures the least stress to the LED.
- 5) Lead cutting after soldering should be performed only after the LED temperature has returned to normal temperature.

## •LED MOUNTING METHOD

- 1) When mounting the LED by using a case, as shown Fig.4, ensure that the mounting holds on the PC board match the pitch of the leads correctly-tolerance of dimensions of the respective components including the LED should be taken into account especially when designing the case, PC board, etc. to prevent pitch misalignment between the leads and board holes, the diameter of the board holes should be slightly larger than the size of the lead. Alternatively, the shape of the holes should be made oval. (See Fig.4)





## LED LAMP APPLICATION

2) Use LEDs with stand-off (Fig.5) or the tube or spacer made of resin (Fig.6) to position the LEDs.

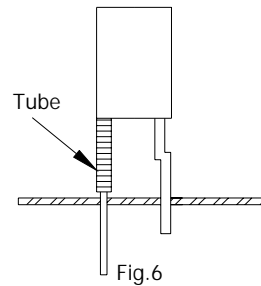

### •FORMED LEAD

1) The lead should be bent at a point located at least 2mm away from the package. Bending should be performed with base fixed means of a jig or pliers (Fig.7)



2) Forming lead should be carried out prior to soldering and never during or after soldering.  
3) Form the lead to ensure alignment between the leads and the hole on board, so that stress against the LED is prevented. (Fig.8)

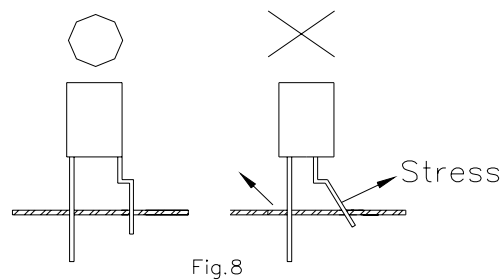



**•LEAD STRENGTH**

1) Bend strength

Do not bend the lead more than twice. (Fig.9)



2) Tensile strength (@Room Temperature)

If the force is 1kg or less, there will be no problem. (Fig.10)



**•HANDLING PRECAUTIONS**

Although rigid against vibration, the LEDs may damaged or scratched if dropped. So take care when handling.

**•CHEMICAL RESISTANCE**

- 1) Avoid exposure to chemicals as it may attack the LED surface and cause discoloration.
- 2) When washing is required, refer to the following table for the proper chemical to be sued. (Immersion time: within 3 minutes at room temperature.)

| SOLVENT           | ADAPTABILITY |
|-------------------|--------------|
| Freon TE          | ⊙            |
| Chlorothene       | ×            |
| Isopropyl Alcohol | ⊙            |
| Thinner           | ×            |
| Acetone           | ×            |
| Trichloroethylene | ×            |

⊙--Usable    ×--Do not use.

NOTE: Influences of ultrasonic cleaning of the LED resin body differ depending on such factors as the oscillator output, size of the PC board and the way in which the LED is mounted. Therefore, ultrasonic cleaning should only be performed after confirming there is no problem by conducting a test under practical.





# LED LAMP PASSED TESTS

## Experiment Item:

| Item                                   | Test Condition  | Reference Standard   |
|--|---|--|
|  | Lamp & IR   |  |
| OPERATION LIFE                         | $T_a : 25 \pm 5^\circ\text{C}$<br>$I_F = 20\text{mA}$ RH : $\leq 60\%RH$<br>① DYNAMIC: $100\text{mA}$ $1\text{ms}$ $1/10$ duty<br>② STATIC STATE: $I_F = 20\text{mA}$<br>TEST TIME:<br>$168\text{HRS}$ ( $-24\text{HRS}$ , $+24\text{HRS}$ )<br>$500\text{HRS}$ ( $-24\text{HRS}$ , $+24\text{HRS}$ )<br>$1000\text{HRS}$ ( $-24\text{HRS}$ , $+72\text{HRS}$ ) | MIL-STD-750 : 1026<br>MIL-STD-883 : 1005<br>JIS C 7021 : B-1                       |
| HIGH TEMPERATURE HIGH HUMIDITY STORAGE | $T_a : 65^\circ\text{C} \pm 5^\circ\text{C}$<br>RH : $90 \sim 95\%RH$<br>TEST TIME : $240\text{HRS} \pm 2\text{HRS}$  | MIL-STD-202 : 103B<br>JIS C 7021 : B-1   |
| TEMPERATURE CYCLING                    | $105^\circ\text{C} \sim 25^\circ\text{C} \sim -55^\circ\text{C} \sim 25^\circ\text{C}$<br>$30\text{min}$ $5\text{min}$ $30\text{min}$ $5\text{min}$<br>10CYCLES   | MIL-STD-202 : 107D<br>MIL-STD-750 : 1051<br>MIL-STD-883 : 1010<br>JIS C 7021 : A-4 |
| THERMAL SHOCK                          | $105^\circ\text{C} \pm 5^\circ\text{C} \sim -55^\circ\text{C} \pm 5^\circ\text{C}$<br>$10\text{min}$ $10\text{min}$<br>10CYCLES   | MIL-STD-202 : 107D<br>MIL-STD-750 : 1051<br>MIL-SYD-883 : 1011                     |
| SOLDER RESISTANCE                      | $T, \text{sol} : 260^\circ\text{C} \pm 5^\circ\text{C}$<br>DWELL TIME : $10 \pm 1\text{sec}$  | MIL-STD-202 : 210A<br>MIL-STD-750-2031<br>JIS C 7021 : A-1                         |
| SOLDERABILITY                          | $T, \text{sol} : 230^\circ\text{C} \pm 5^\circ\text{C}$<br>DWELL TIME : $5 \pm 1\text{sec}$   | MIL-STD-202 : 208D<br>MIL-STD-750 : 2026<br>MIL-STD-883 : 2003<br>JIS C 7021 : A-2 |

### Drive Method

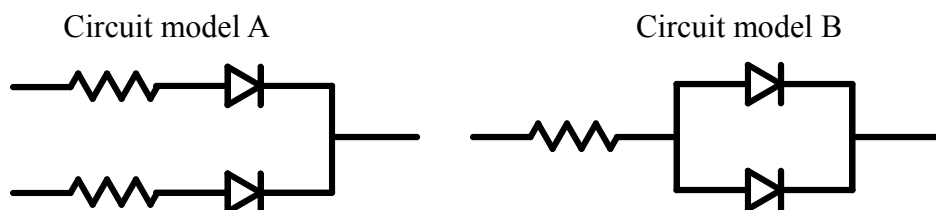

(A) Recommended circuit.

(B) The difference of brightness between LED's could be found due to the  $V_f$ - $I_f$  characteristics of LED.