

PVT442

Microelectronic Power IC
HEXFET® Power MOSFET Relay
Single Pole, Normally Closed
0-400V, 170mA AC/DC

General Description

PVT442 Photovoltaic Relay is a single-pole, normally closed solid-state relay that can replace electromechanical relays in many applications. It utilizes a HEXFET Power MOSFET as the output switch, driven by an integrated circuit photovoltaic generator of novel construction. The output switch is controlled by radiation from a GaAIAs light emitting diode (LED) which is optically isolated from the photovoltaic generator.

PVT442 is ideally suited for worldwide telecom applications: On/Off Hook switch, Parallel telecom equipment setup, and general switching.

PVT442 Relays are packaged in a 6-pin, molded DIP package with either thru-hole or "gull-wing" surface mount terminals. It is available in standard plastic shipping tubes or on Tape-and-Reel. Refer to Part Identification information.

Applications

- On/Off Hook switch
- Parallel telecom equipment setup
- General switching

Features

- HEXFET Power MOSFET output
- Bounce-free operation
- 4,000 V_{RMS} I/O isolation
- Linear AC/DC operation
- Solid-State Reliability
- BABT certified
- ESD Tolerance:
 - 4000V Human Body Model
 - 500V Machine Model

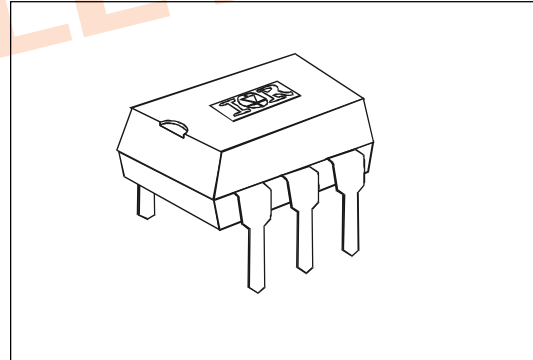

Part Identification

PVT442	thru-hole
PVT442S	SMT
PVT442S-T	SMT, tape and reel

(HEXFET® is a trademark of International Rectifier)

Electrical Specifications ($-40^{\circ}\text{C} \leq T_A \leq +85^{\circ}\text{C}$ unless otherwise specified)

INPUT CHARACTERISTICS	Limits	Units
Min. Control Current (See Fig.1)	3.0	mA
Control Current Range (Caution: current limit input LED, see Fig.6)	3.0 to 25	mA
Max. Reverse Voltage	7.0	V

OUTPUT CHARACTERISTICS	Limits	Units
Operating Voltage Range	0 to ± 400	$V_{(DC \text{ or AC peak})}$
Max. Load Current @ $T_A = +40^{\circ}\text{C}$ (See Fig.1)	"A" Connection "B" Connection "C" Connection	mA (AC or DC) mA (DC) mA (DC)
Max. On-State Resistance @ $T_A = +25^{\circ}\text{C}$ For 50mA Pulsed Load, 5mA Control (See Fig.4)	"A" Connection "B" Connection "C" Connection	Ω Ω Ω
Max. Off-State Leakage @ $T_A = +25^{\circ}\text{C}$, $\pm 400\text{V}$ (See Fig.5) @ 5mA Control		μA
Max. Turn-On Time @ $T_A = +25^{\circ}\text{C}$ (See Fig. 7) For 50mA, 100 V _{DC} Load, 5mA Control		ms
Max. Turn-Off Time @ $T_A = +25^{\circ}\text{C}$ (See Fig. 7) For 50mA, 100 V _{DC} Load, 5mA Control		ms
Max. Output Capacitance @ 50V _{DC} (See Fig. 2)		pF

GENERAL CHARACTERISTICS	Limits	Units
Min. Dielectric Strength, Input-Output	4000	V_{RMS}
Min. Insulation Resistance, Input-Output @ $T_A = +25^{\circ}\text{C}$, 50%RH, 100V _{DC}	10^{12}	Ω
Max. Capacitance, Input-Output	1.0	pF
Max. Pin Soldering Temperature (10 seconds max.)	+260	$^{\circ}\text{C}$
Ambient Temperature Range: Operating	-40 to +85	$^{\circ}\text{C}$
Storage	-40 to +100	$^{\circ}\text{C}$

Connection Diagrams

"B" Connection

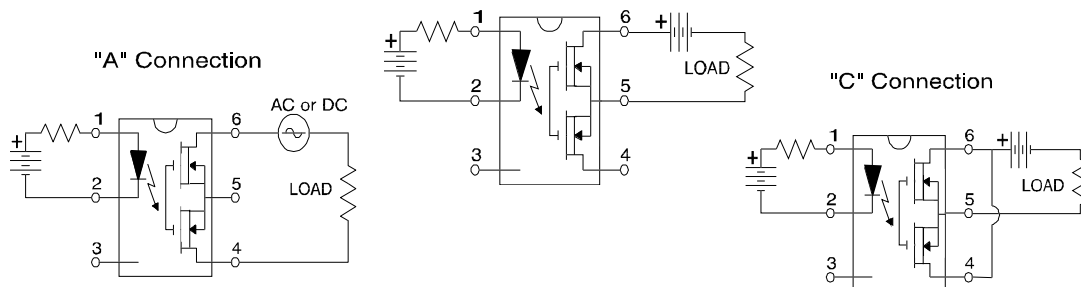

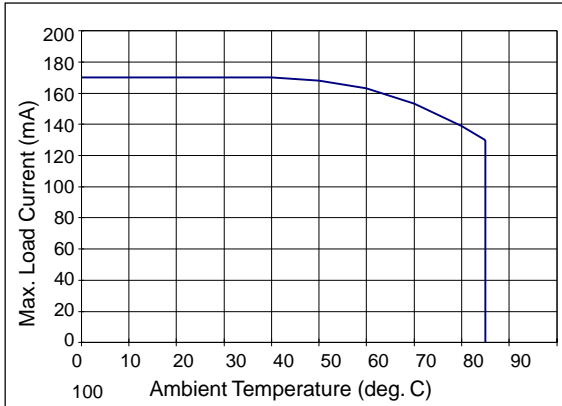

Figure 1. Current Derating Curve, "A" connection

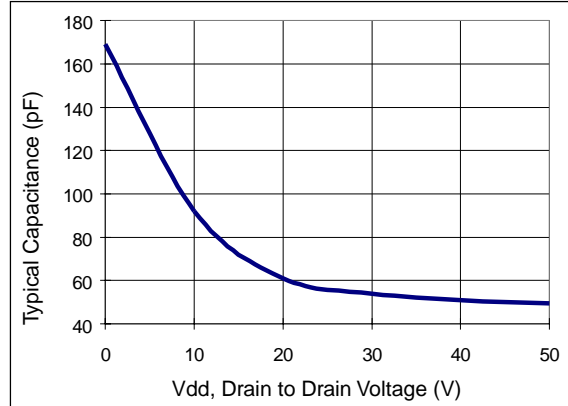

Figure 2. Typical Output Capacitance

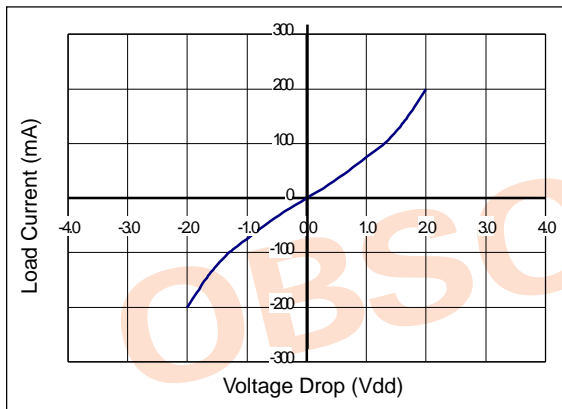

Figure 3. Linearity Characteristics, "A" connection

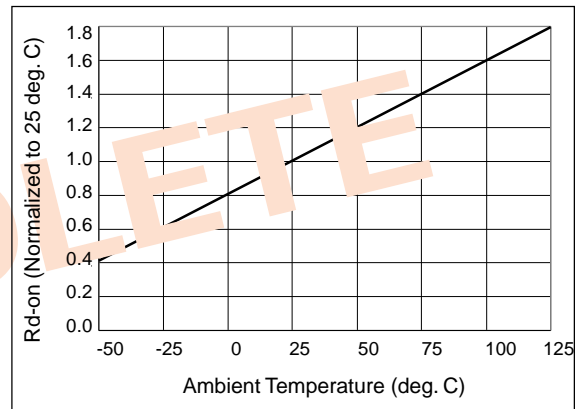

Figure 4. Typical Normalized On-Resistance; "A" conn

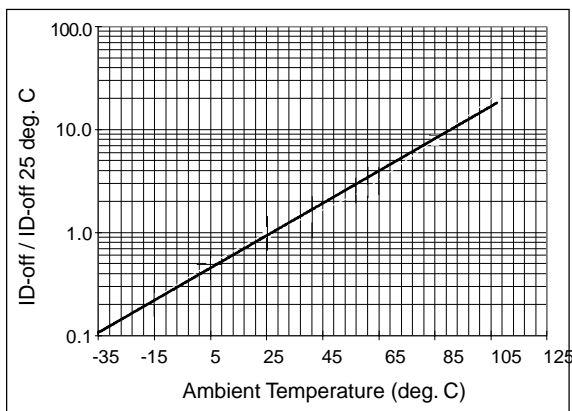

Figure 5. Typical Normalized Off-State Leakage

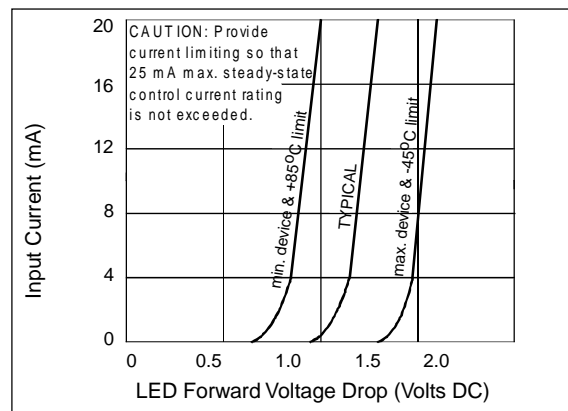

Figure 6. Input Characteristics (Current Controlled)

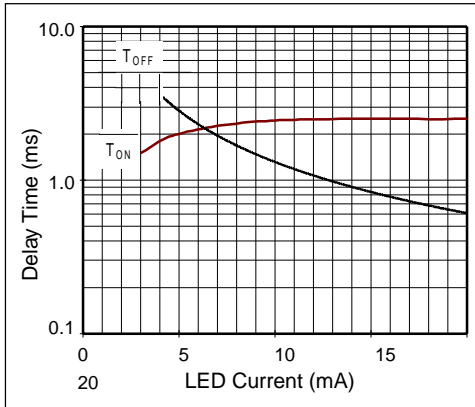

Figure 7. Typical Delay Times

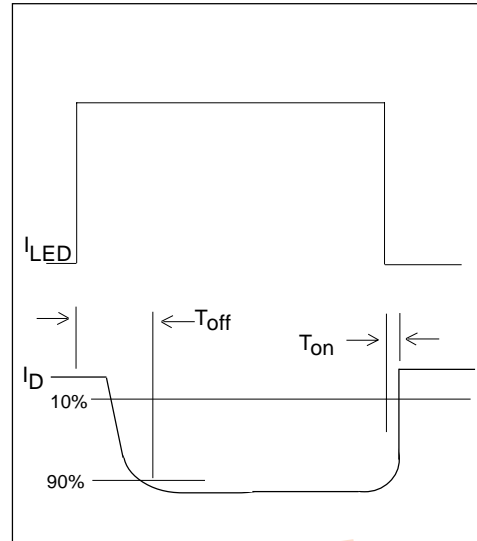
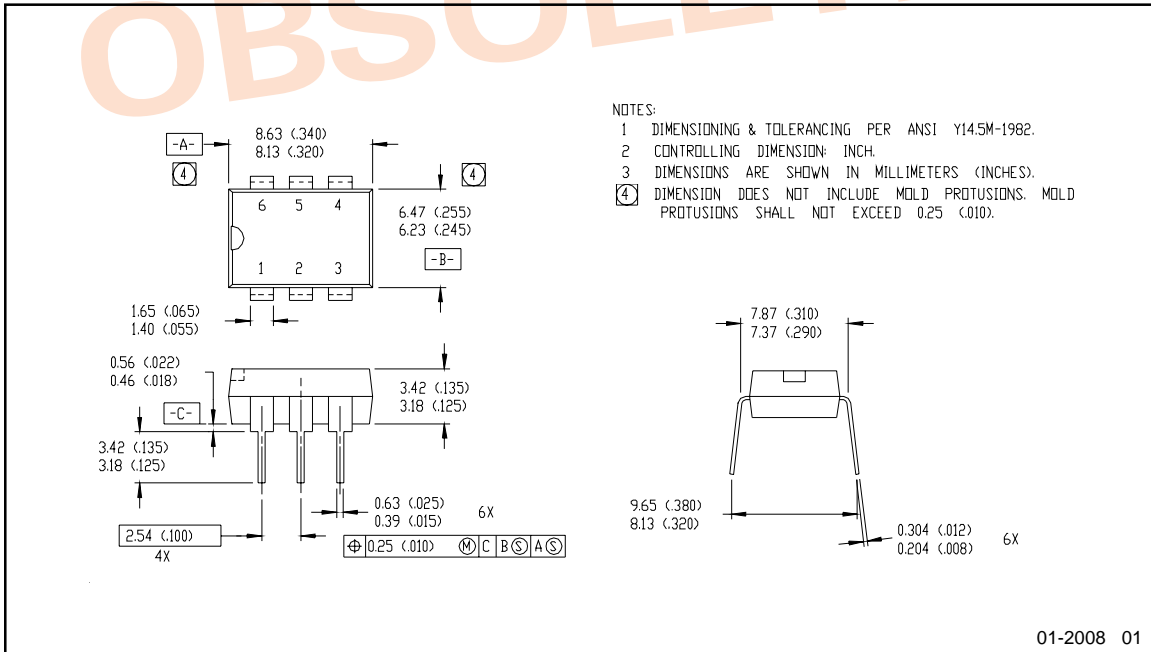
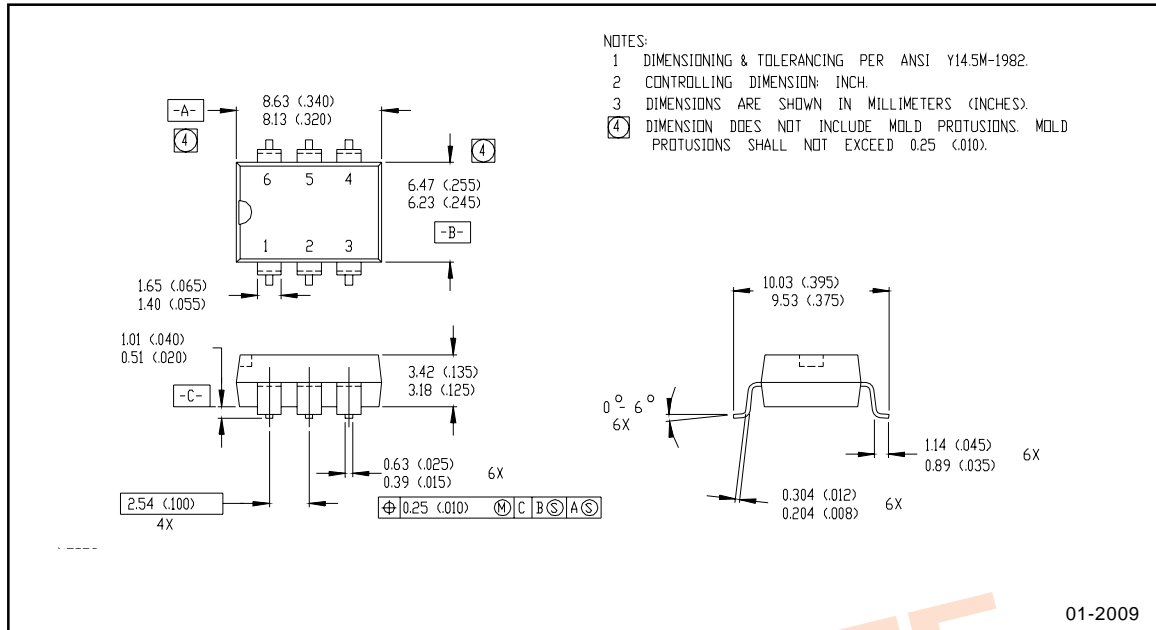

Figure 8. Delay Time Definitions

Case Outline



Case Outline



OBSOLETE