

PBSS5160DS

60 V, 1 A PNP low V_{CEsat} (BISS) transistor

Rev. 02 — 28 June 2005

Product data sheet

1. Product profile

1.1 General description

PNP/PNP low V_{CEsat} Breakthrough in Small Signal (BISS) transistor pair in a SOT457 (SC-74) Surface Mounted Device (SMD) plastic package.

NPN complement: PBSS4160DS.

1.2 Features

- Low collector-emitter saturation voltage V_{CEsat}
- High collector current capability: I_C and I_{CM}
- High collector current gain (h_{FE}) at high I_C
- High efficiency due to less heat generation
- Smaller required Printed-Circuit Board (PCB) area than for conventional transistors

1.3 Applications

- Dual low power switches (e.g. motors, fans)
- Automotive applications

1.4 Quick reference data

Table 1: Quick reference data

| Symbol | Parameter | Conditions | Min | Typ | Max | Unit |
|-------------|---|----------------------------------|-------|-----|-----|------------|
| V_{CEO} | collector-emitter voltage | open base | - | - | -60 | V |
| I_C | collector current (DC) | | [1] - | - | -1 | A |
| I_{CM} | peak collector current | single pulse; $t_p \leq 1$ ms | - | - | -2 | A |
| R_{CEsat} | collector-emitter saturation resistance | $I_C = -1$ A; $I_B = -100$ mA | [2] - | 250 | 330 | m Ω |

[1] Device mounted on a ceramic PCB, Al_2O_3 , standard footprint.

[2] Pulse test: $t_p \leq 300$ μ s; $\delta \leq 0.02$.

2. Pinning information

Table 2: Pinning

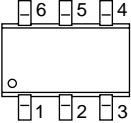
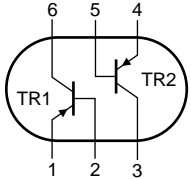
| Pin | Description | Simplified outline | Symbol |
|-----|---------------|---|---|
| 1 | emitter TR1 |  |  |
| 2 | base TR1 | | |
| 3 | collector TR2 | | |
| 4 | emitter TR2 | | |
| 5 | base TR2 | | |
| 6 | collector TR1 | | |

sym018

3. Ordering information

Table 3: Ordering information

| Type number | Package | | |
|-------------|---------|--|---------|
| | Name | Description | Version |
| PBSS5160DS | SC-74 | plastic surface mounted package; 6 leads | SOT457 |

4. Marking

Table 4: Marking codes

| Type number | Marking code |
|-------------|--------------|
| PBSS5160DS | A5 |

5. Limiting values

Table 5: Limiting values

In accordance with the Absolute Maximum Rating System (IEC 60134).

| Symbol | Parameter | Conditions | Min | Max | Unit |
|-----------------------|---------------------------|-------------------------------|-----|-------|------|
| Per transistor | | | | | |
| V_{CBO} | collector-base voltage | open emitter | - | -80 | V |
| V_{CEO} | collector-emitter voltage | open base | - | -60 | V |
| V_{EBO} | emitter-base voltage | open collector | - | -5 | V |
| I_C | collector current (DC) | | [1] | -0.77 | A |
| | | | [2] | -0.9 | A |
| | | | [3] | -1 | A |
| I_{CM} | peak collector current | single pulse; $t_p \leq 1$ ms | - | -2 | A |
| I_B | base current (DC) | | - | -300 | mA |
| I_{BM} | peak base current | single pulse; $t_p \leq 1$ ms | - | -1 | A |

Table 5: Limiting values ...continued

In accordance with the Absolute Maximum Rating System (IEC 60134).

| Symbol | Parameter | Conditions | Min | Max | Unit | |
|-------------------|-------------------------|-----------------------------|-----|------|------|----|
| P_{tot} | total power dissipation | $T_{amb} \leq 25\text{ °C}$ | [1] | - | 290 | mW |
| | | | [2] | - | 370 | mW |
| | | | [3] | - | 450 | mW |
| Per device | | | | | | |
| P_{tot} | total power dissipation | $T_{amb} \leq 25\text{ °C}$ | [1] | - | 420 | mW |
| | | | [2] | - | 560 | mW |
| | | | [3] | - | 700 | mW |
| T_j | junction temperature | | - | 150 | °C | |
| T_{amb} | ambient temperature | | -65 | +150 | °C | |
| T_{stg} | storage temperature | | -65 | +150 | °C | |

- [1] Device mounted on an FR4 PCB, single-sided copper, tin-plated and standard footprint.
- [2] Device mounted on an FR4 PCB, single-sided copper, tin-plated, mounting pad for collector 1 cm².
- [3] Device mounted on a ceramic PCB, Al₂O₃, standard footprint.

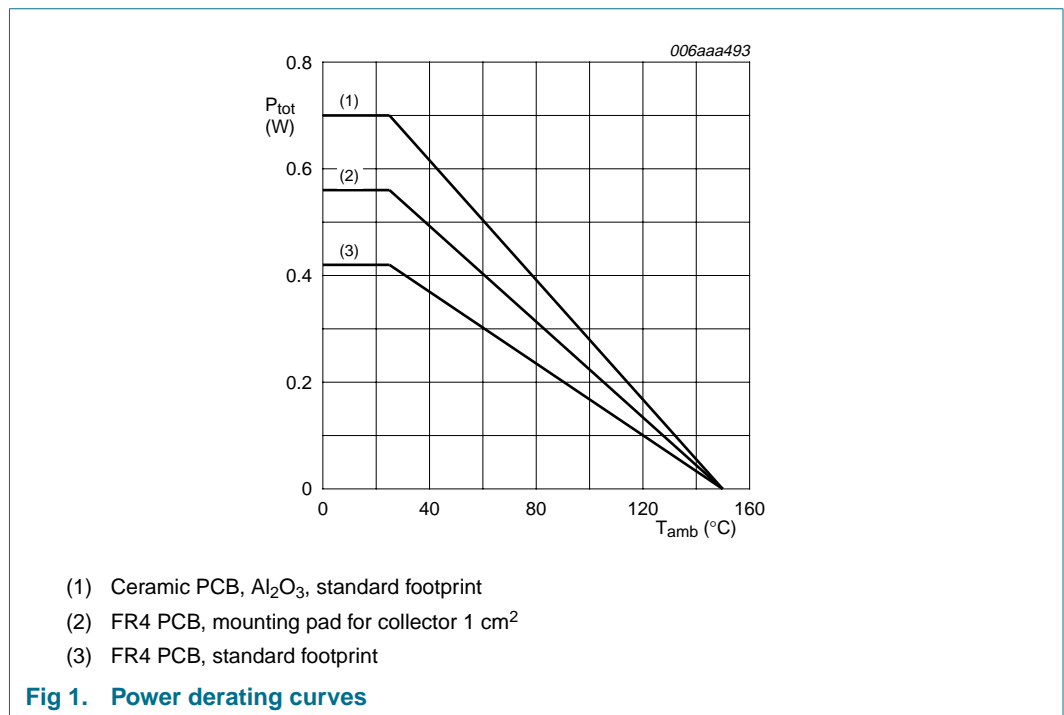

6. Thermal characteristics

Table 6: Thermal characteristics

| Symbol | Parameter | Conditions | Min | Typ | Max | Unit | |
|-----------------------|--|-------------|-----|-----|-----|------|-----|
| Per transistor | | | | | | | |
| $R_{th(j-a)}$ | thermal resistance from junction to ambient | in free air | [1] | - | - | 431 | K/W |
| | | | [2] | - | - | 338 | K/W |
| | | | [3] | - | - | 278 | K/W |
| $R_{th(j-sp)}$ | thermal resistance from junction to solder point | | - | - | 105 | K/W | |
| Per device | | | | | | | |
| $R_{th(j-a)}$ | thermal resistance from junction to ambient | in free air | [1] | - | - | 298 | K/W |
| | | | [2] | - | - | 223 | K/W |
| | | | [3] | - | - | 179 | K/W |

- [1] Device mounted on an FR4 PCB, single-sided copper, tin-plated and standard footprint.
- [2] Device mounted on an FR4 PCB, single-sided copper, tin-plated, mounting pad for collector 1 cm².
- [3] Device mounted on a ceramic PCB, Al₂O₃, standard footprint.

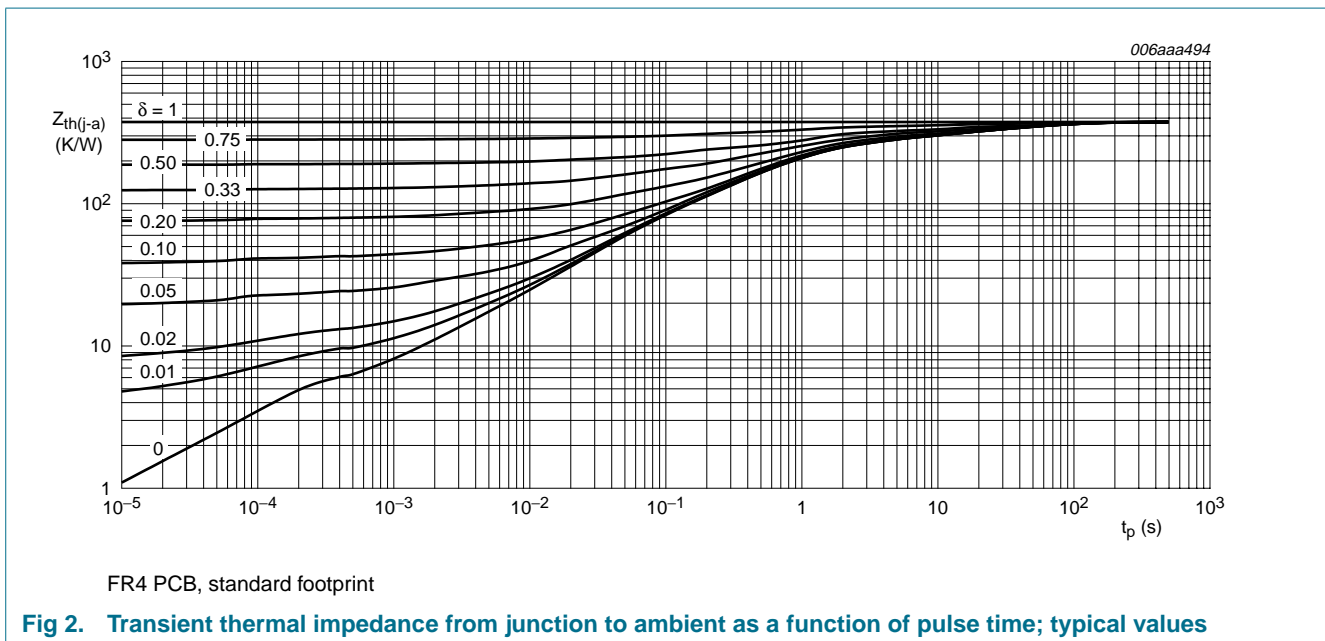

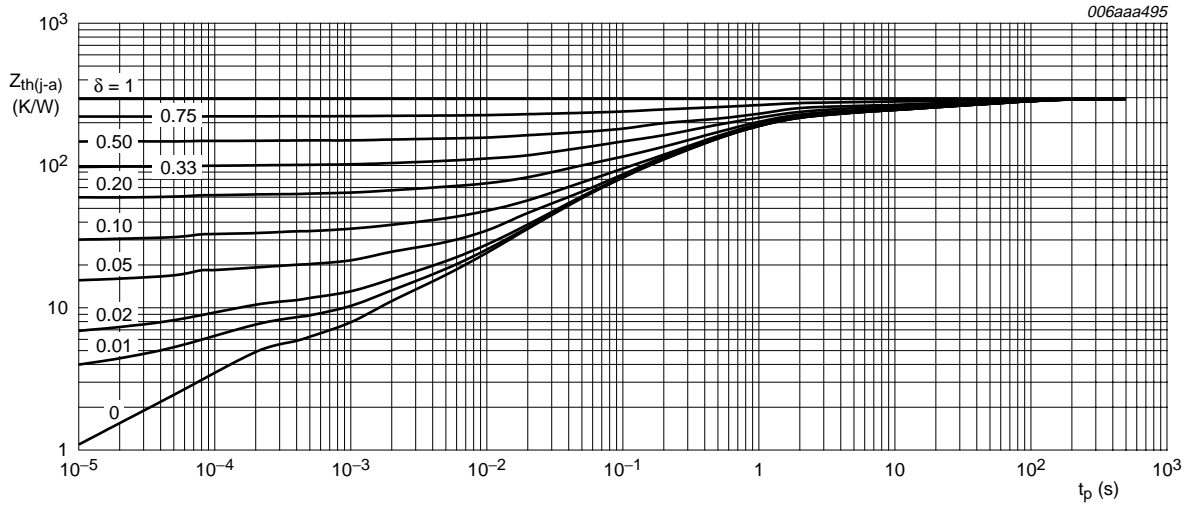

FR4 PCB, mounting pad for collector 1 cm²

Fig 3. Transient thermal impedance from junction to ambient as a function of pulse time; typical values

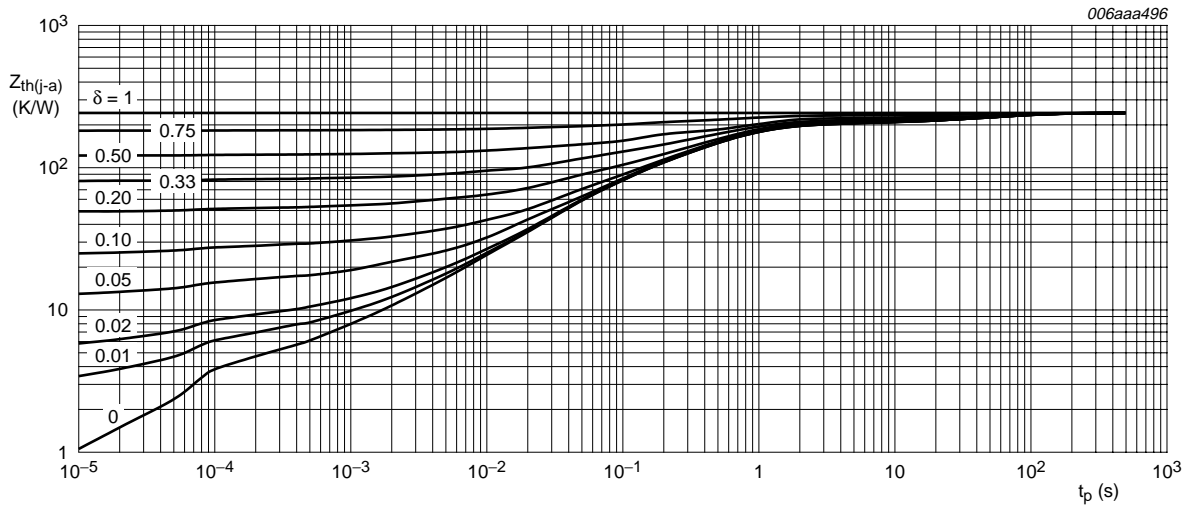

Ceramic PCB, Al₂O₃, standard footprint

Fig 4. Transient thermal impedance from junction to ambient as a function of pulse time; typical values

7. Characteristics

Table 7: Characteristics

$T_{amb} = 25\text{ }^{\circ}\text{C}$ unless otherwise specified.

| Symbol | Parameter | Conditions | Min | Typ | Max | Unit |
|-----------------------|---|--|---------|-------|------|------------------|
| Per transistor | | | | | | |
| I_{CBO} | collector-base cut-off current | $V_{CB} = -60\text{ V}; I_E = 0\text{ A}$ | - | - | -100 | nA |
| | | $V_{CB} = -60\text{ V}; I_E = 0\text{ A}; T_j = 150\text{ }^{\circ}\text{C}$ | - | - | -50 | μA |
| I_{CES} | collector-emitter cut-off current | $V_{CE} = -60\text{ V}; V_{BE} = 0\text{ V}$ | - | - | -100 | nA |
| I_{EBO} | emitter-base cut-off current | $V_{EB} = -5\text{ V}; I_C = 0\text{ A}$ | - | - | -100 | nA |
| h_{FE} | DC current gain | $V_{CE} = -5\text{ V}; I_C = -1\text{ mA}$ | 200 | 350 | - | |
| | | $V_{CE} = -5\text{ V}; I_C = -500\text{ mA}$ | [1] 150 | 250 | - | |
| | | $V_{CE} = -5\text{ V}; I_C = -1\text{ A}$ | [1] 100 | 160 | - | |
| V_{CEsat} | collector-emitter saturation voltage | $I_C = -100\text{ mA}; I_B = -1\text{ mA}$ | - | -110 | -165 | mV |
| | | $I_C = -500\text{ mA}; I_B = -50\text{ mA}$ | - | -120 | -175 | mV |
| | | $I_C = -1\text{ A}; I_B = -100\text{ mA}$ | [1] - | -250 | -330 | mV |
| V_{BEsat} | base-emitter saturation voltage | $I_C = -1\text{ A}; I_B = -50\text{ mA}$ | [1] - | -0.95 | -1.1 | V |
| R_{CEsat} | collector-emitter saturation resistance | $I_C = -1\text{ A}; I_B = -100\text{ mA}$ | [1] - | 250 | 330 | $\text{m}\Omega$ |
| V_{BEon} | base-emitter turn-on voltage | $I_C = -1\text{ A}; V_{CE} = -5\text{ V}$ | [1] - | -0.82 | -0.9 | V |
| t_d | delay time | $I_C = -0.5\text{ A}; I_{Bon} = -25\text{ mA}; I_{Boff} = 25\text{ mA}$ | - | 11 | - | ns |
| t_r | rise time | | - | 30 | - | ns |
| t_{on} | turn-on time | | - | 41 | - | ns |
| t_s | storage time | | - | 205 | - | ns |
| t_f | fall time | | - | 55 | - | ns |
| t_{off} | turn-off time | | - | 260 | - | ns |
| f_T | transition frequency | $V_{CE} = -10\text{ V}; I_C = -50\text{ mA}; f = 100\text{ MHz}$ | 150 | 185 | - | MHz |
| C_c | collector capacitance | $V_{CB} = -10\text{ V}; I_E = i_e = 0\text{ A}; f = 1\text{ MHz}$ | - | 9 | 15 | pF |

[1] Pulse test: $t_p \leq 300\text{ }\mu\text{s}; \delta \leq 0.02$.

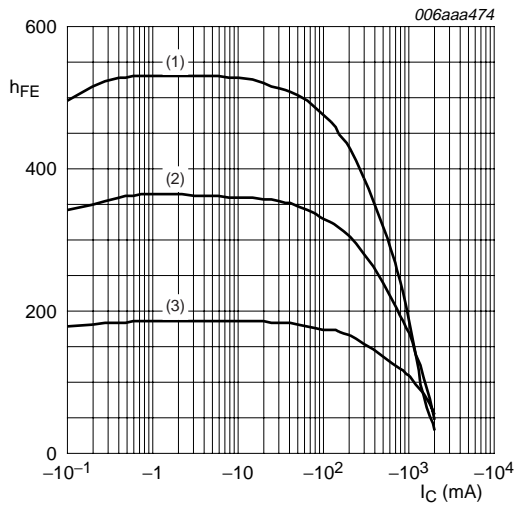

$V_{CE} = -5\text{ V}$
 (1) $T_{amb} = 100\text{ }^{\circ}\text{C}$
 (2) $T_{amb} = 25\text{ }^{\circ}\text{C}$
 (3) $T_{amb} = -55\text{ }^{\circ}\text{C}$

Fig 5. DC current gain as a function of collector current; typical values

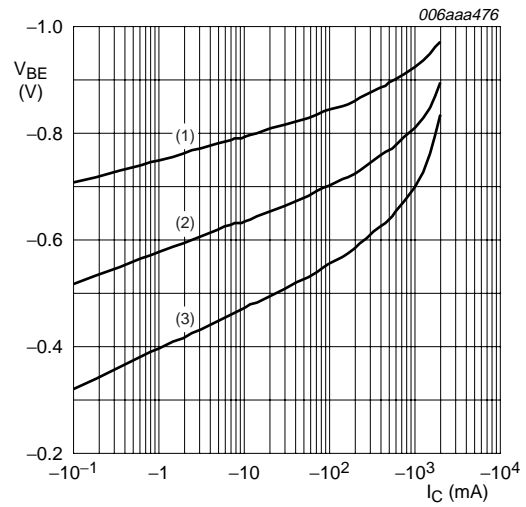

$V_{CE} = -5\text{ V}$
 (1) $T_{amb} = -55\text{ }^{\circ}\text{C}$
 (2) $T_{amb} = 25\text{ }^{\circ}\text{C}$
 (3) $T_{amb} = 100\text{ }^{\circ}\text{C}$

Fig 6. Base-emitter voltage as a function of collector current; typical values

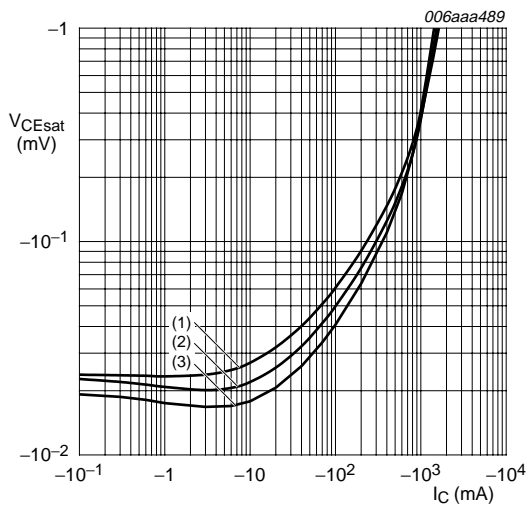

$I_C/I_B = 20$
 (1) $T_{amb} = 100\text{ }^{\circ}\text{C}$
 (2) $T_{amb} = 25\text{ }^{\circ}\text{C}$
 (3) $T_{amb} = -55\text{ }^{\circ}\text{C}$

Fig 7. Collector-emitter saturation voltage as a function of collector current; typical values

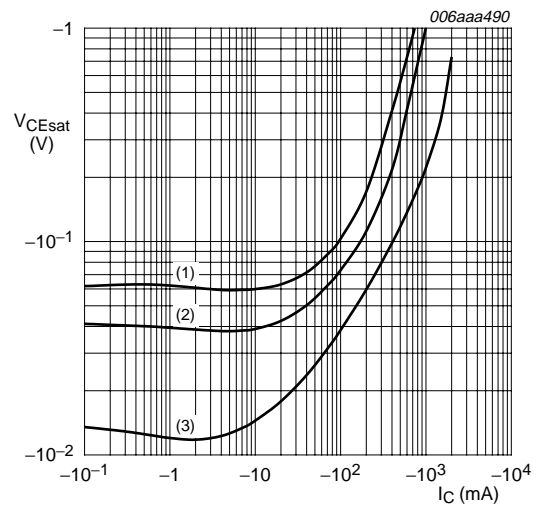

$T_{amb} = 25\text{ }^{\circ}\text{C}$
 (1) $I_C/I_B = 100$
 (2) $I_C/I_B = 50$
 (3) $I_C/I_B = 10$

Fig 8. Collector-emitter saturation voltage as a function of collector current; typical values

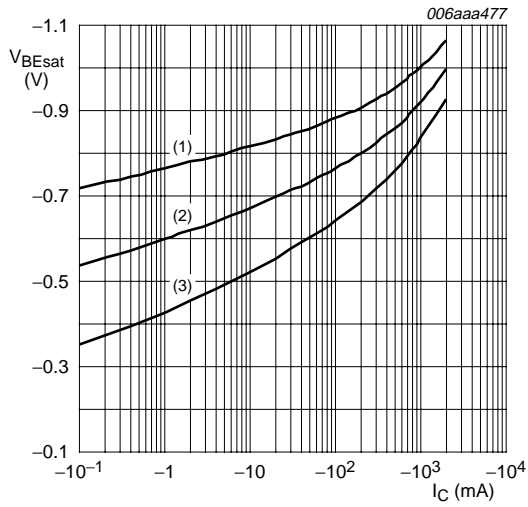

$I_C/I_B = 20$
 (1) $T_{amb} = -55\text{ °C}$
 (2) $T_{amb} = 25\text{ °C}$
 (3) $T_{amb} = 100\text{ °C}$

Fig 9. Base-emitter saturation voltage as a function of collector current; typical values

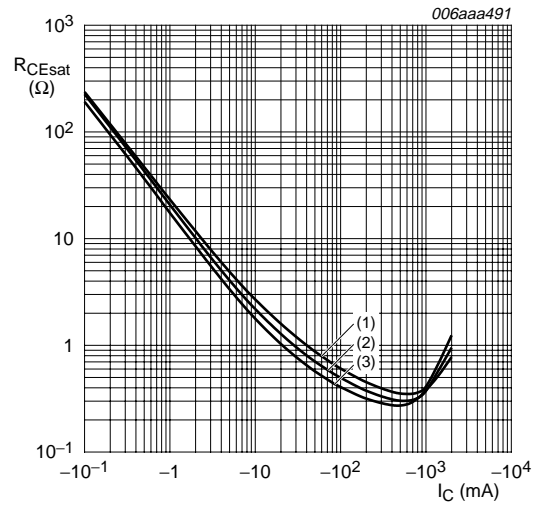

$I_C/I_B = 20$
 (1) $T_{amb} = 100\text{ °C}$
 (2) $T_{amb} = 25\text{ °C}$
 (3) $T_{amb} = -55\text{ °C}$

Fig 10. Collector-emitter saturation resistance as a function of collector current; typical values

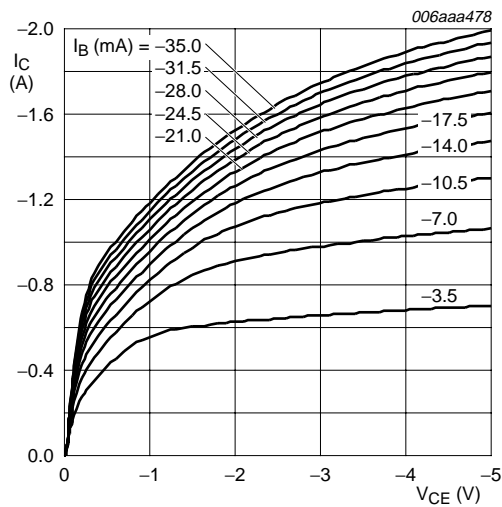

$T_{amb} = 25\text{ °C}$

Fig 11. Collector current as a function of collector-emitter voltage; typical values

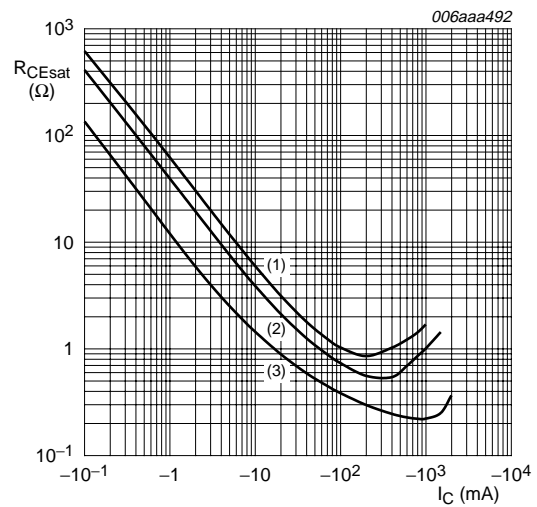

$T_{amb} = 25\text{ °C}$
 (1) $I_C/I_B = 100$
 (2) $I_C/I_B = 50$
 (3) $I_C/I_B = 10$

Fig 12. Collector-emitter saturation resistance as a function of collector current; typical values

8. Test information

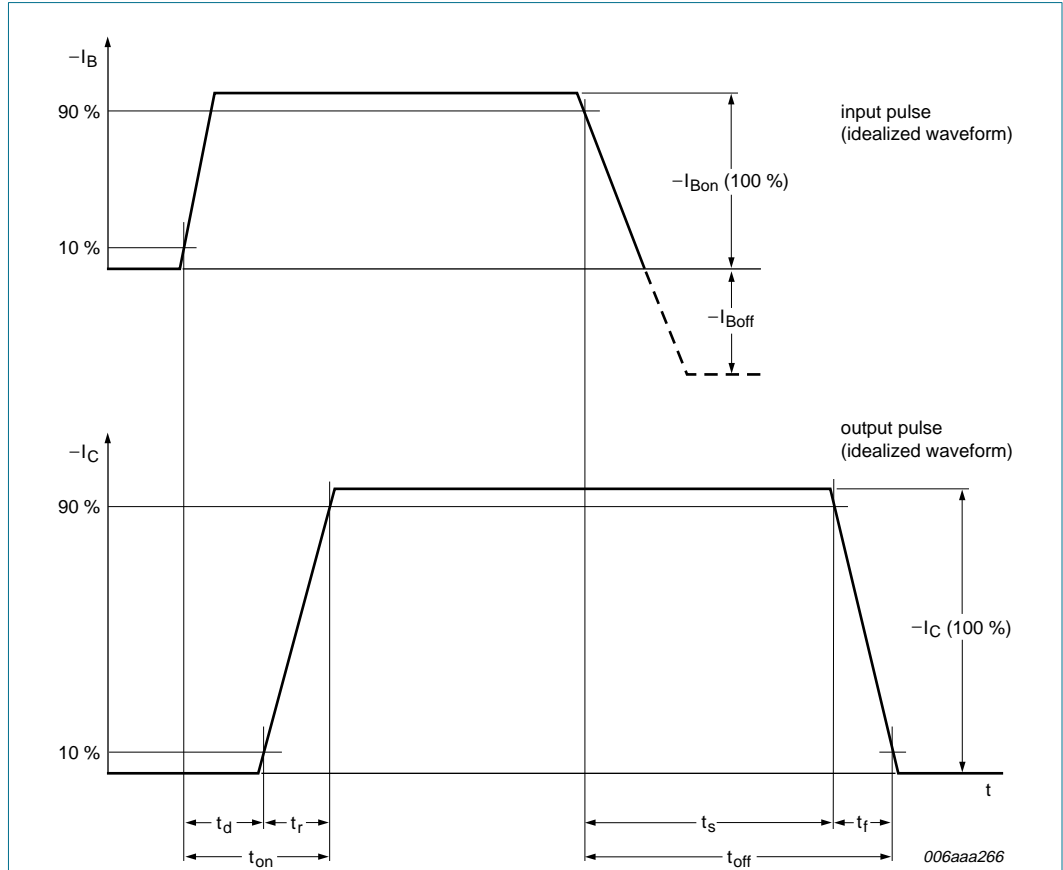
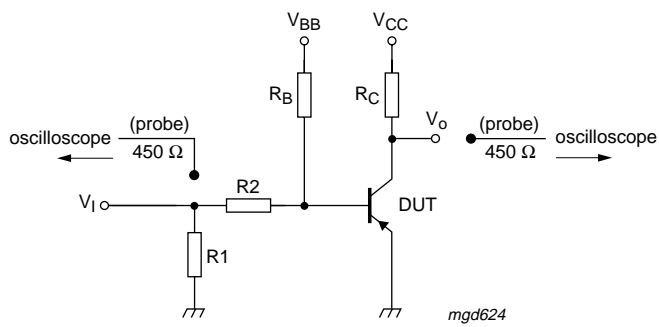

Fig 13. BISS transistor switching time definition



$I_C = -0.5 \text{ A}$; $I_{Bon} = -25 \text{ mA}$; $I_{Boff} = 25 \text{ mA}$; $R_1 = \text{open}$; $R_2 = 100 \text{ }\Omega$; $R_B = 300 \text{ }\Omega$; $R_C = 20 \text{ }\Omega$

Fig 14. Test circuit for switching times

9. Package outline

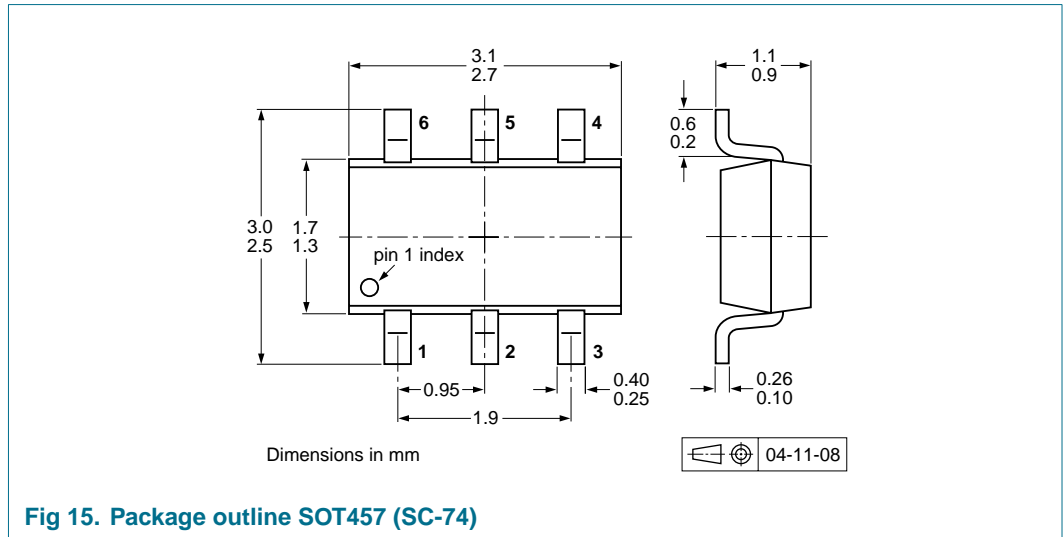

10. Packing information

Table 8: Packing methods

The indicated -xxx are the last three digits of the 12NC ordering code. [\[1\]](#)

| Type number | Package | Description | Packing quantity | |
|-------------|---------|------------------------------------|--------------------------|-------|
| | | | 3000 | 10000 |
| PBSS5160DS | SOT457 | 4 mm pitch, 8 mm tape and reel; T1 | [2] -115 | -135 |
| | | 4 mm pitch, 8 mm tape and reel; T2 | [3] -125 | -165 |

[1] For further information and the availability of packing methods, see [Section 17](#).

[2] T1: normal taping

[3] T2: reverse taping

11. Soldering

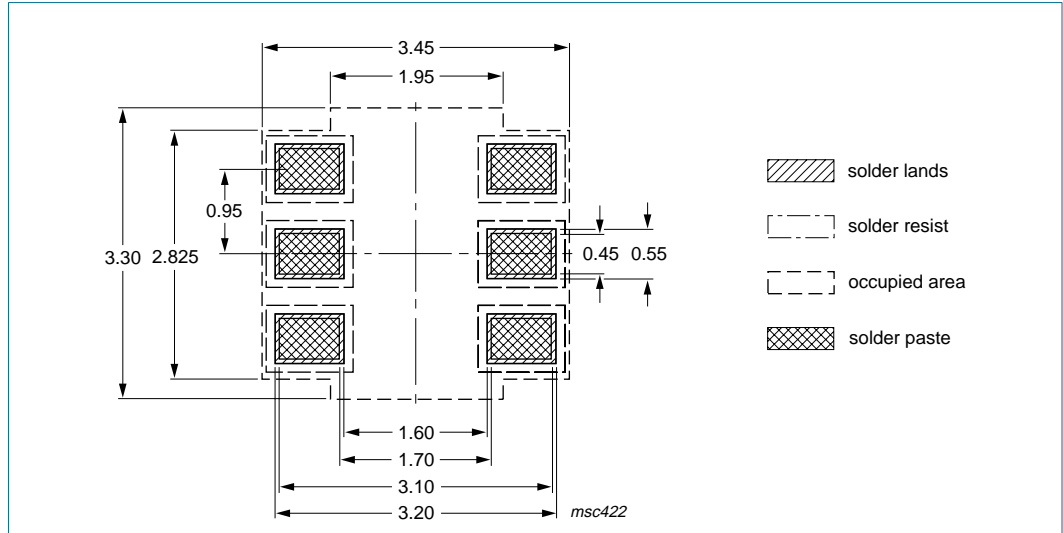

Dimensions in mm

Fig 16. Reflow soldering footprint

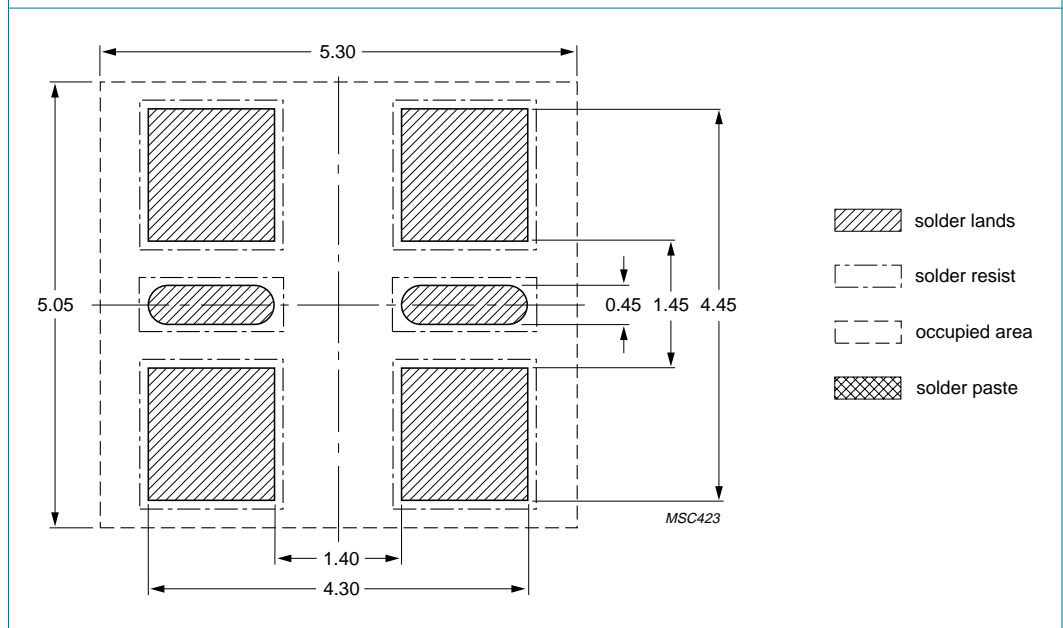

Dimensions in mm

Fig 17. Wave soldering footprint

12. Revision history

Table 9: Revision history

| Document ID | Release date | Data sheet status | Change notice | Doc. number | Supersedes |
|--|--------------|----------------------|---------------|----------------|--------------|
| PBSS5160DS_2 | 20050628 | Product data sheet | - | 9397 750 15186 | PBSS5160DS_1 |
| Modifications: | | | | | |
| <ul style="list-style-type: none"> • Product status changed • Table 7: Switching time parameters t_d, t_r, t_{on}, t_s, t_f and t_{off} added • Figure 13 "BISS transistor switching time definition": added • Figure 14 "Test circuit for switching times": added • Section 10 "Packing information": added • Section 11 "Soldering": added • Section 16 "Trademarks": added | | | | | |
| PBSS5160DS_1 | 20040716 | Objective data sheet | - | 9397 750 12704 | - |

13. Data sheet status

| Level | Data sheet status ^[1] | Product status ^{[2] [3]} | Definition |
|-------|----------------------------------|-----------------------------------|--|
| I | Objective data | Development | This data sheet contains data from the objective specification for product development. Philips Semiconductors reserves the right to change the specification in any manner without notice. |
| II | Preliminary data | Qualification | This data sheet contains data from the preliminary specification. Supplementary data will be published at a later date. Philips Semiconductors reserves the right to change the specification without notice, in order to improve the design and supply the best possible product. |
| III | Product data | Production | This data sheet contains data from the product specification. Philips Semiconductors reserves the right to make changes at any time in order to improve the design, manufacturing and supply. Relevant changes will be communicated via a Customer Product/Process Change Notification (CPCN). |

[1] Please consult the most recently issued data sheet before initiating or completing a design.

[2] The product status of the device(s) described in this data sheet may have changed since this data sheet was published. The latest information is available on the Internet at URL <http://www.semiconductors.philips.com>.

[3] For data sheets describing multiple type numbers, the highest-level product status determines the data sheet status.

14. Definitions

Short-form specification — The data in a short-form specification is extracted from a full data sheet with the same type number and title. For detailed information see the relevant data sheet or data handbook.

Limiting values definition — Limiting values given are in accordance with the Absolute Maximum Rating System (IEC 60134). Stress above one or more of the limiting values may cause permanent damage to the device. These are stress ratings only and operation of the device at these or at any other conditions above those given in the Characteristics sections of the specification is not implied. Exposure to limiting values for extended periods may affect device reliability.

Application information — Applications that are described herein for any of these products are for illustrative purposes only. Philips Semiconductors make no representation or warranty that such applications will be suitable for the specified use without further testing or modification.

15. Disclaimers

Life support — These products are not designed for use in life support appliances, devices, or systems where malfunction of these products can reasonably be expected to result in personal injury. Philips Semiconductors

17. Contact information

For additional information, please visit: <http://www.semiconductors.philips.com>

For sales office addresses, send an email to: sales.addresses@www.semiconductors.philips.com

customers using or selling these products for use in such applications do so at their own risk and agree to fully indemnify Philips Semiconductors for any damages resulting from such application.

Right to make changes — Philips Semiconductors reserves the right to make changes in the products - including circuits, standard cells, and/or software - described or contained herein in order to improve design and/or performance. When the product is in full production (status 'Production'), relevant changes will be communicated via a Customer Product/Process Change Notification (CPCN). Philips Semiconductors assumes no responsibility or liability for the use of any of these products, conveys no license or title under any patent, copyright, or mask work right to these products, and makes no representations or warranties that these products are free from patent, copyright, or mask work right infringement, unless otherwise specified.

16. Trademarks

Notice — All referenced brands, product names, service names and trademarks are the property of their respective owners.

18. Contents

| | | |
|-----------|--|-----------|
| 1 | Product profile | 1 |
| 1.1 | General description. | 1 |
| 1.2 | Features | 1 |
| 1.3 | Applications | 1 |
| 1.4 | Quick reference data. | 1 |
| 2 | Pinning information | 2 |
| 3 | Ordering information | 2 |
| 4 | Marking | 2 |
| 5 | Limiting values | 2 |
| 6 | Thermal characteristics | 4 |
| 7 | Characteristics | 6 |
| 8 | Test information | 9 |
| 9 | Package outline | 10 |
| 10 | Packing information | 10 |
| 11 | Soldering | 11 |
| 12 | Revision history | 12 |
| 13 | Data sheet status | 13 |
| 14 | Definitions | 13 |
| 15 | Disclaimers | 13 |
| 16 | Trademarks | 13 |
| 17 | Contact information | 13 |



© Koninklijke Philips Electronics N.V. 2005

All rights are reserved. Reproduction in whole or in part is prohibited without the prior written consent of the copyright owner. The information presented in this document does not form part of any quotation or contract, is believed to be accurate and reliable and may be changed without notice. No liability will be accepted by the publisher for any consequence of its use. Publication thereof does not convey nor imply any license under patent- or other industrial or intellectual property rights.

Date of release: 28 June 2005
Document number: 9397 750 15186

Published in The Netherlands