

# 8-bit Microcontrollers

CMOS

## F<sup>2</sup>MC-8FX MB95130MB Series

MB95136MB/F133MBS/F133NBS/F133JBS/F134MBS/F134NBS/F134JBS/  
MB95F136MBS/F136NBS/F136JBS/F133MBW/F133NBW/F133JBW/F134MBW/  
MB95F134NBW/F134JBW/F136MBW/F136NBW/F136JBW/FV100D-103

### ■ DESCRIPTION

The MB95130MB series is general-purpose, single-chip microcontrollers. In addition to a compact instruction set, the microcontrollers contain a variety of peripheral functions.

Note : F<sup>2</sup>MC is the abbreviation of FUJITSU Flexible Microcontroller.

### ■ FEATURES

- F<sup>2</sup>MC-8FX CPU core
  - Instruction set optimized for controllers
    - Multiplication and division instructions
    - 16-bit arithmetic operations
    - Bit test branch instruction
    - Bit manipulation instructions etc.
- Clock
  - Main clock
  - Main PLL clock
  - Sub clock (for dual clock product)
  - Sub PLL clock (for dual clock product)

(Continued)

Be sure to refer to the "Check Sheet" for the latest cautions on development.

"Check Sheet" is seen at the following support page

URL : <http://www.fujitsu.com/global/services/microelectronics/product/micom/support/index.html>

"Check Sheet" lists the minimal requirement items to be checked to prevent problems beforehand in system development.

# MB95130MB Series

(Continued)

- Timer
  - 8/16-bit compound timer × 1 channel
  - 8/16-bit PPG × 1 channel
  - 16-bit PPG × 1 channel
  - Timebase timer × 1 channel
  - Watch prescaler (for dual clock product) × 1 channel
- LIN-UART × 1 channel
  - LIN function, Clock asynchronous (UART) or clock synchronous (SIO) serial data transfer capable
  - Full duplex double buffer
- UART/SIO × 1 channel
  - Clock asynchronous (UART) or clock synchronous (SIO) serial data transfer capable
  - Full duplex double buffer
- External interrupt × 8 channels
  - Interrupt by edge detection (rising, falling, or both edges can be selected)
  - Can be used to recover from low-power consumption (standby) modes.
- 8/10-bit A/D converter × 8 channels
  - 8-bit or 10-bit resolution can be selected.
- Low-power consumption (standby) mode
  - Stop mode
  - Sleep mode
  - Watch mode (for dual clock product)
  - Timebase timer mode
- I/O port
  - The number of maximum ports
    - Single clock product : 20 ports
    - Dual clock product : 18 ports
  - Configuration
    - General-purpose I/O ports (COMS) : Single clock product : 20 ports  
Dual clock product : 18 ports
- Programmable input voltage levels of port  
Automotive input level / CMOS input level / hysteresis input level
- Flash memory security function  
Protects the content of Flash memory (Flash memory device only)

# MB95130MB Series

## ■ MEMORY LINEUP

	Flash memory	RAM
MB95F133MBS/F133NBS/F133JBS	8 Kbytes	256 bytes
MB95F133MBW/F133NBW/F133JBW		
MB95F134MBS/F134NBS/F134JBS	16 Kbytes	512 bytes
MB95F134MBW/F134NBW/F134JBW		
MB95F136MBS/F136NBS/F136JBS	32 Kbytes	1 Kbyte
MB95F136MBW/F136NBW/F136JBW		

# MB95130MB Series

## ■ PRODUCT LINEUP

Part number	MB95136MB	MB95 F133MBS/ F134MBS/ F136MBS	MB95 F133NBS/ F134NBS/ F136NBS	MB95 F133MBW/ F134MBW/ F136MBW	MB95 F133NBW/ F134NBW/ F136NBW	MB95 F133JBS/ F134JBS/ F136JBS	MB95 F133JBW/ F134JBW/ F136JBW
Type	MASK ROM product	Flash memory product					
ROM capacity*1	32 Kbytes (Max)						
RAM capacity*1	1 Kbyte (Max)						
Reset output	Yes					No	
Option*2	Clock system	Selectable single/dual clock*3	Single clock		Dual clock		Single clock Dual clock
	Low voltage detection reset	Yes/No	No	Yes	No	Yes	
	Clock supervisor	Yes/No	No			Yes	
CPU functions	Number of basic instructions : 136 Instruction bit length : 8 bits Instruction length : 1 to 3 bytes Data bit length : 1, 8, and 16 bits Minimum instruction execution time : 61.5 ns (at machine clock frequency 16.25 MHz) Interrupt processing time : 0.6 μs (at machine clock frequency 16.25 MHz)						
Peripheral functions	General-purpose I/O port	<ul style="list-style-type: none"> <li>• Single clock product : 20 ports</li> <li>• Dual clock product : 18 ports</li> </ul> Programmable input voltage levels of port : Automotive input level / CMOS input level / hysteresis input level					
	Timebase timer (1 channel)	Interrupt cycle : 0.5 ms, 2.1 ms, 8.2 ms, 32.8 ms (at main oscillation clock 4 MHz)					
	Watchdog timer	Reset generated cycle At main oscillation clock 10 MHz : Min 105 ms At sub oscillation clock 32.768 kHz (for dual clock product) : Min 250 ms					
	Wild register	Capable of replacing 3 bytes of ROM data					
	UART/SIO (1 channel)	Data transfer capable in UART/SIO Full duplex double buffer, variable data length (5/6/7/8-bit), built-in baud rate generator NRZ type transfer format, error detected function LSB-first or MSB-first can be selected. Clock asynchronous (UART) or clock synchronous (SIO) serial data transfer capable					
	LIN-UART (1 channel)	Dedicated reload timer allowing a wide range of communication speeds to be set. Full duplex double buffer. Clock asynchronous (UART) or clock synchronous (SIO) serial data transfer capable LIN functions available as the LIN master or LIN slave.					
8/10-bit A/D converter (8 channels)	8-bit or 10-bit resolution can be selected.						

(Continued)

# MB95130MB Series

(Continued)

Part number	MB95136MB	MB95 F133MBS/ F134MBS/ F136MBS	MB95 F133NBS/ F134NBS/ F136NBS	MB95 F133MBW/ F134MBW/ F136MBW	MB95 F133NBW/ F134NBW/ F136NBW	MB95 F133JBS/ F134JBS/ F136JBS	MB95 F133JBW/ F134JBW/ F136JBW
Parameter							
Peripheral functions	8/16-bit compound timer (1 channel)	Each channel of the timer can be used as “8-bit timer x 2 channels” or “16-bit timer x 1 channel”. Built-in timer function, PWC function, PWM function, capture function and square wave-form output Count clock: 7 internal clocks and external clock can be selected.					
	16-bit PPG (1 channel)	PWM mode or one-shot mode can be selected. Counter operating clock: Eight selectable clock sources Support for external trigger start					
	8/16-bit PPG (1 channel)	Each channel of the PPG can be used as “8-bit PPG x 2 channels” or “16-bit PPG x 1 channel”. Counter operating clock: Eight selectable clock sources					
	Watch counter (for dual clock product) (1 channel)	Count clock : Four selectable clock sources (125 ms, 250 ms, 500 ms, or 1 s) Counter value can be set from 0 to 63. (Capable of counting for 1 minute when selecting clock source 1 second and setting counter value to 60)					
	Watch prescaler (for dual clock product) (1 channel)	Four selectable interval times (125 ms, 250 ms, 500 ms, or 1 s)					
	External interrupt (8 channels)	Interrupt by edge detection (rising, falling, or both edges can be selected.) Can be used to recover from standby modes.					
Flash memory	Supports automatic programming, Embedded Algorithm™*4 Write/Erase/Erase-Suspend/Resume commands A flag indicating completion of the algorithm Number of write/erase cycles (Minimum) : 10000 times Data retention time : 20 years Erase can be performed on each block Block protection with external programming voltage Flash Security Feature for protecting the content of the Flash (MB95F136MBS/F136NBS/F136JBS/F136MBW/F136NBW/F136JBW)						
Standby mode	Sleep, stop, watch (for dual clock product), and timebase timer						

\*1 : For ROM capacity and RAM capacity, refer to “■ MEMORY LINEUP”.

\*2 : For details of option, refer to “■ MASK OPTION”.

\*3 : Specify clock mode when ordering MASK ROM.

\*4 : Embedded Algorithm is a trade mark of Advanced Micro Devices Inc.

Note : Part number of evaluation product in MB95130MB series is MB95FV100D-103.  
When using it, the MCU board (MB2146-303A) is required.

# MB95130MB Series

## ■ OSCILLATION STABILIZATION WAIT TIME

The initial value of the main clock oscillation stabilization wait time is fixed to the maximum value. The maximum value is shown below.

Oscillation stabilization wait time	Remarks
$(2^{14}-2) / F_{CH}$	Approx. 4.10 ms (at main oscillation clock 4 MHz)

## ■ PACKAGES AND CORRESPONDING PRODUCTS

Part number Package	MB95136MB	MB95F133MBS MB95F133NBS MB95F134MBS MB95F134NBS MB95F136MBS MB95F136NBS MB95F133JBS MB95F134JBS MB95F136JBS	MB95F133MBW MB95F133NBW MB95F134MBW MB95F134NBW MB95F136MBW MB95F136NBW MB95F133JBW MB95F134JBW MB95F136JBW	MB95FV100D-103
FPT-28P-M17	○	○	○	×
FPT-30P-M02	○	○	○	×
BGA-224P-M08	×	×	×	○

- : Available  
 × : Unavailable

## ■ DIFFERENCES AMONG PRODUCTS AND NOTES ON SELECTING PRODUCTS

- Notes on using evaluation products

The Evaluation product has not only the functions of the MB95130MB series but also those of other products to support software development for multiple series and models of the F<sup>2</sup>MC-8FX. The I/O addresses for peripheral resources not used by the MB95130MB series are therefore access-barred. Read/write access to those access-barred addresses may cause peripheral resources supposed to be unused to operate, resulting in unexpected malfunctions of hardware or software.

Particularly, do not use word access to an odd-numbered-byte address in the prohibited areas (If such access is used, the address may be read or written unexpectedly) .

Also, as the read values of prohibited addresses on the evaluation product are different to the values on the flash memory and mask ROM products, do not use these values in the software processing.

The Evaluation product does not support the functions of some bits in single-byte registers. Read/write access to these bits does not cause hardware malfunctions. No particular precautions are required to the flash memory and mask ROM products, as they have the identical read/write operation to the evaluation products.

- Difference of memory spaces

If the amount of memory on the Evaluation product is different from that of the Flash memory or MASK ROM product, carefully check the difference in the amount of memory from the model to be actually used when developing software.

For details of memory space, refer to “■ CPU CORE”.

- Current consumption

- The current consumption of Flash memory product is greater than for MASK ROM product.

- For details of current consumption, refer to “■ ELECTRICAL CHARACTERISTICS”.

- Package

For details of information on each package, refer to “■ PACKAGES AND CORRESPONDING PRODUCTS” and “■ PACKAGE DIMENSION”.

- Operating voltage

The operating voltage is different among the Evaluation, Flash memory, and MASK ROM products.

For details of the operating voltage, refer to “■ ELECTRICAL CHARACTERISTICS”.

- Difference MOD Pins

A pull-down resistor is provided for the MOD pin of the MASK ROM product.

# MB95130MB Series

## ■ PIN ASSIGNMENT

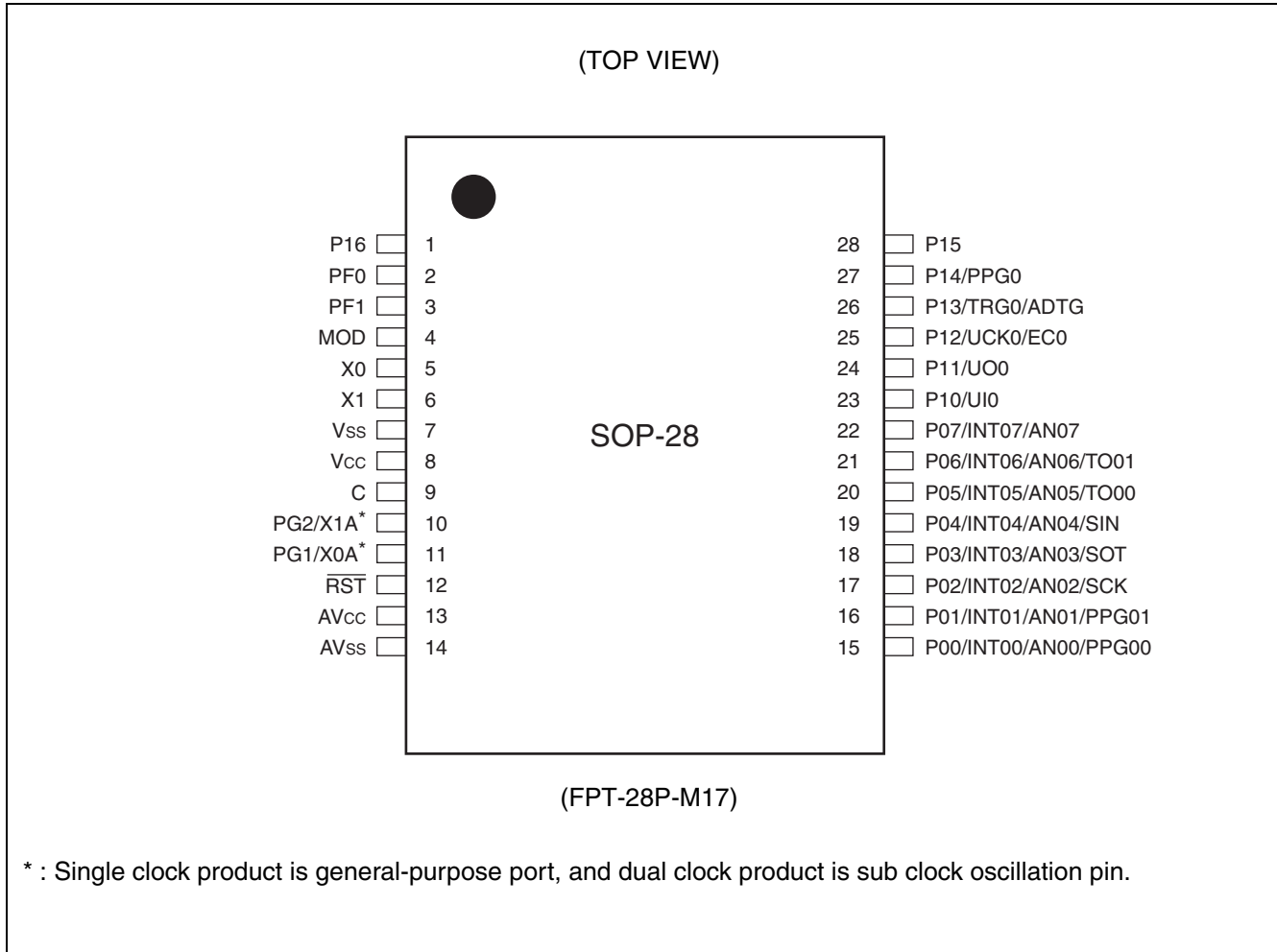



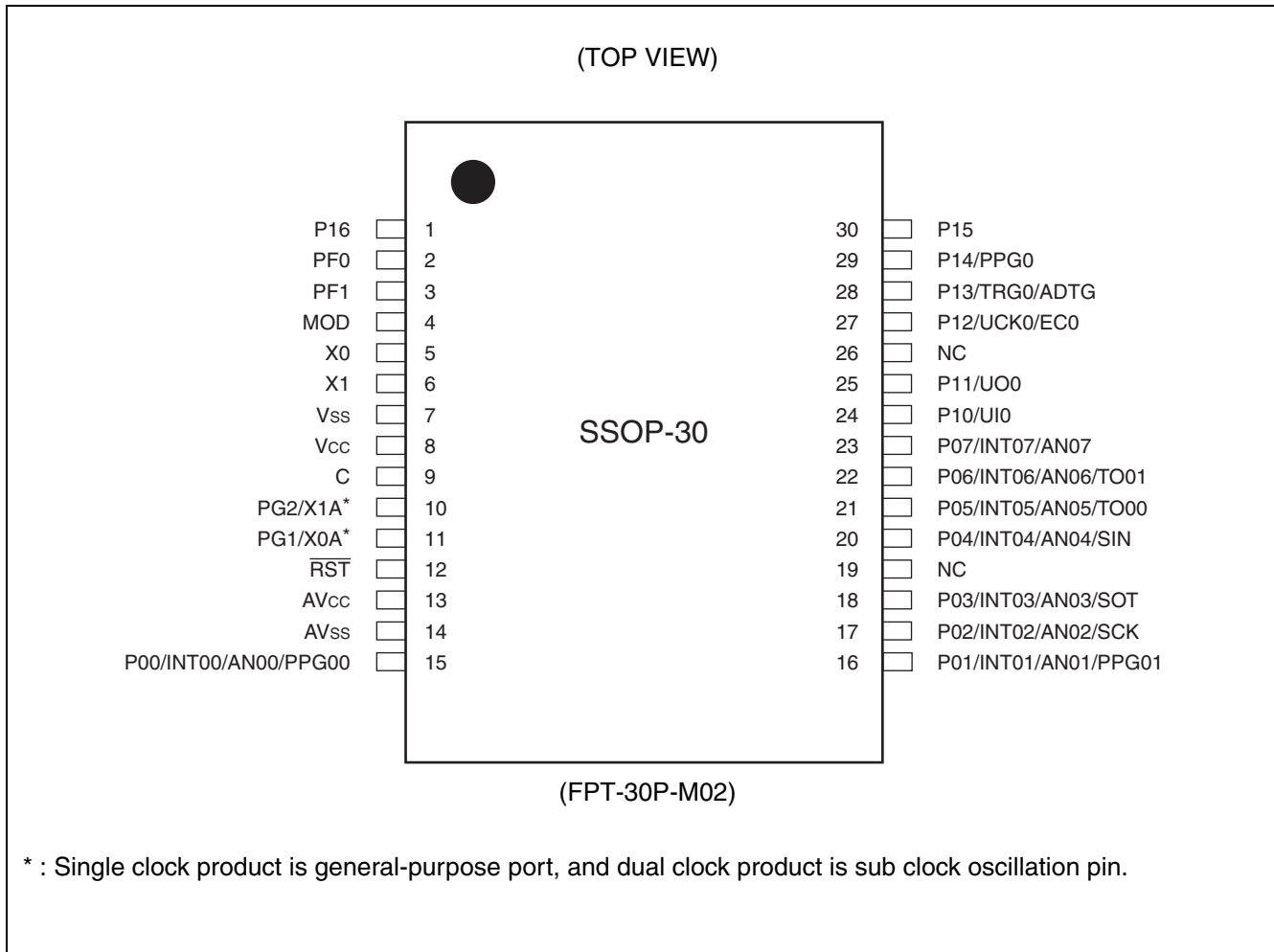

# MB95130MB Series

## ■ PIN DESCRIPTION

Pin no.		Pin name	I/O circuit type*3	Function
SSOP*1	SOP*2			
1	1	P16	H	General-purpose I/O port
2	2	PF0	K	General-purpose I/O port for large current
3	3	PF1		
4	4	MOD	B	Operating mode designation pin
5	5	X0	A	Main clock oscillation input pin
6	6	X1		Main clock oscillation input/output pin
7	7	V <sub>SS</sub>	—	Power supply pin (GND)
8	8	V <sub>CC</sub>	—	Power supply pin
9	9	C	—	Capacity connection pin
10	10	PG2/X1A	H/A	Single clock product is general-purpose port (PG2) . Dual clock product is sub clock input/output oscillation pin (32 kHz) .
11	11	PG1/X0A		Single clock product is general-purpose port (PG1) . Dual clock product is sub clock input oscillation pin (32 kHz) .
12	12	RST	B'	Reset pin
13	13	AV <sub>CC</sub>	—	A/D converter power supply pin
14	14	AV <sub>SS</sub>	—	A/D converter power supply pin (GND)
15	15	P00/INT00/ AN00/ PPG00	D	General-purpose I/O port Shared with external interrupt input (INT00), A/D converter analog input (AN00) and 8/16-bit PPG ch.0 output (PPG00).
16	16	P01/INT01/ AN01/ PPG01		General-purpose I/O port Shared with external interrupt input (INT01), A/D converter analog input (AN01) and 8/16-bit PPG ch.0 output (PPG01).
17	17	P02/INT02/ AN02/SCK		General-purpose I/O port Shared with external interrupt input (INT02), A/D converter analog input (AN02) and LIN-UART clock I/O (SCK).
18	18	P03/INT03/ AN03/SOT		General-purpose I/O port Shared with external interrupt input (INT03), A/D converter analog input (AN03) and LIN-UART data output (SOT).
20	19	P04/INT04/ AN04/SIN	E	General-purpose I/O port Shared with external interrupt input (INT04), A/D converter analog input (AN04) and LIN-UART data input (SIN).
21	20	P05/INT05/ AN05/TO00	D	General-purpose I/O port Shared with external interrupt input (INT05 & INT06), A/D converter analog input (AN05 & AN06) and 8/16-bit compound timer ch.0 output (TO00 & TO01).
22	21	P06/INT06/ AN06/TO01		
23	22	P07/INT07/ AN07		

(Continued)

# MB95130MB Series

(Continued)

Pin no.		Pin name	I/O circuit type*3	Function
SSOP*1	SOP*2			
24	23	P10/UIO	G	General-purpose I/O port Shared with UART/SIO ch.0 data input (UI0)
25	24	P11/UO0	H	General-purpose I/O port Shared with UART/SIO ch.0 data output (UO0)
27	25	P12/UCK0/ EC0		General-purpose I/O port Shared with UART/SIO ch.0 clock I/O (UCK0) and 8/16-bit compound timer ch.0 clock input (EC0)
28	26	P13/TRG0/ ADTG		General-purpose I/O port Shared with 16-bit PPG ch.0 trigger input (TRG0) and A/D converter trigger input (ADTG)
29	27	P14/PPG0		General-purpose I/O port Shared with 16-bit PPG ch.0 output (PPG0)
30	28	P15		General-purpose I/O port
19,26	—	NC	—	Internally connected pins. Be sure to leave it open.

\*1 : FPT-30P-M02

\*2 : FPT-28P-M17

\*3 : For the I/O circuit type, refer to “■ I/O CIRCUIT TYPE”.

# MB95130MB Series

## ■ I/O CIRCUIT TYPE

Type	Circuit	Remarks
A		<ul style="list-style-type: none"> <li>• Oscillation circuit</li> <li>• High-speed side Feedback resistance: approx. 1 MΩ</li> <li>• Low-speed side Feedback resistance: approx. 10 MΩ</li> </ul>
B		<ul style="list-style-type: none"> <li>• Only for input</li> <li>• Hysteresis input only for MASK ROM product</li> <li>• Pull-down resistor available only to MASK ROM product</li> </ul>
B'		<ul style="list-style-type: none"> <li>• Hysteresis input only for MASK ROM product</li> <li>• Reset output</li> </ul>
D		<ul style="list-style-type: none"> <li>• CMOS output</li> <li>• Hysteresis input</li> <li>• Analog input</li> <li>• Pull-up control available</li> <li>• Automotive input</li> </ul>

(Continued)

(Continued)

Type	Circuit	Remarks
E	<p>The circuit diagram for Type E shows a pull-up resistor R connected to a P-channel MOSFET (P-ch) and an N-channel MOSFET (N-ch). The P-ch MOSFET is controlled by a Pull-up control signal. The N-ch MOSFET is controlled by a Standby control signal. The output of the P-ch MOSFET is labeled as Digital output. The output of the N-ch MOSFET is also labeled as Digital output. The circuit also includes an Analog input, a CMOS input, a Hysteresis input, and an Automotive input. The A/D control signal is connected to the CMOS input. The External interrupt control signal is connected to the Standby control input.</p>	<ul style="list-style-type: none"> <li>• CMOS output</li> <li>• CMOS input</li> <li>• Hysteresis input</li> <li>• Analog input</li> <li>• Pull-up control available</li> <li>• Automotive input</li> </ul>
G	<p>The circuit diagram for Type G shows a pull-up resistor R connected to a P-channel MOSFET (P-ch) and an N-channel MOSFET (N-ch). The P-ch MOSFET is controlled by a Pull-up control signal. The N-ch MOSFET is controlled by a Standby control signal. The output of the P-ch MOSFET is labeled as Digital output. The output of the N-ch MOSFET is also labeled as Digital output. The circuit also includes a CMOS input, a Hysteresis input, and an Automotive input.</p>	<ul style="list-style-type: none"> <li>• CMOS output</li> <li>• CMOS input</li> <li>• Hysteresis input</li> <li>• Pull-up control available</li> <li>• Automotive input</li> </ul>
H	<p>The circuit diagram for Type H shows a pull-up resistor R connected to a P-channel MOSFET (P-ch) and an N-channel MOSFET (N-ch). The P-ch MOSFET is controlled by a Pull-up control signal. The N-ch MOSFET is controlled by a Standby control signal. The output of the P-ch MOSFET is labeled as Digital output. The output of the N-ch MOSFET is also labeled as Digital output. The circuit also includes a Hysteresis input and an Automotive input.</p>	<ul style="list-style-type: none"> <li>• CMOS output</li> <li>• Hysteresis input</li> <li>• Pull-up control available</li> <li>• Automotive input</li> </ul>
K	<p>The circuit diagram for Type K shows a P-channel MOSFET (P-ch) and an N-channel MOSFET (N-ch). The P-ch MOSFET is controlled by a Standby control signal. The N-ch MOSFET is controlled by a Standby control signal. The output of the P-ch MOSFET is labeled as Digital output. The output of the N-ch MOSFET is also labeled as Digital output. The circuit also includes a Hysteresis input and an Automotive input.</p>	<ul style="list-style-type: none"> <li>• CMOS output</li> <li>• Hysteresis input</li> <li>• Automotive input</li> </ul>

# MB95130MB Series

## ■ HANDLING DEVICES

- Preventing latch-up

Care must be taken to ensure that maximum voltage ratings are not exceeded when the devices are used.

Latch-up may occur on CMOS ICs if voltage higher than  $V_{CC}$  or lower than  $V_{SS}$  is applied to input and output pins other than medium- and high-withstand voltage pins or if voltage higher than the rating voltage is applied between  $V_{CC}$  pin and  $V_{SS}$  pin.

When latch-up occurs, power supply current increases rapidly and might thermally damage elements.

Also, take care to prevent the analog power supply voltage ( $AV_{CC}$ ) and analog input voltage from exceeding the digital power supply voltage ( $V_{CC}$ ) when the analog system power supply is turned on or off.

- Stable supply voltage

Supply voltage should be stabilized.

A sudden change in power supply voltage may cause a malfunction even within the guaranteed operating range of the  $V_{CC}$  power supply voltage.

For stabilization, in principle, keep the variation in  $V_{CC}$  ripple (p-p value) in a commercial frequency range (50 / 60 Hz) not to exceed 10% of the standard  $V_{CC}$  value and suppress the voltage variation so that the transient variation rate does not exceed 0.1 V/ms during a momentary change such as when the power supply is switched.

- Precautions for use of external clock

Even when an external clock is used, oscillation stabilization wait time is required for power-on reset, wake-up from the sub clock mode or stop mode.

## PIN CONNECTION

- Treatment of unused pins

Leaving unused input pins unconnected can cause abnormal operation or latch-up, leading to permanent damage. Unused input pins should always be pulled up or down through resistance of at least 2 k $\Omega$ .

Any unused input/output pins may be set to the output mode and left open, or set to the input mode and treated the same as unused input pins. If there is any unused output pin, make it open.

- Treatment of power supply pins on A/D converter

Connect to be  $AV_{CC} = V_{CC}$  and  $AV_{SS} = V_{SS}$  even if the A/D converter is not in use.

Noise riding on the  $AV_{CC}$  pin may cause accuracy degradation. So, connect approx. 0.1  $\mu$ F ceramic capacitor as a bypass capacitor between  $AV_{CC}$  and  $AV_{SS}$  pins in the vicinity of this device.

- Power Supply Pins

In products with multiple  $V_{CC}$  or  $V_{SS}$  pins, the pins of the same potential are internally connected in the device to avoid abnormal operations including latch-up. However, all the pins must be connected to external power supply and a ground line to lower the electro-magnetic emission level, to prevent abnormal operation of strobe signals caused by the rise in the ground level, and to conform to the total output current rating. Moreover, connect the current supply source with the  $V_{CC}$  and  $V_{SS}$  pins of this device at the low impedance.

It is also advisable to connect a ceramic bypass capacitor of approximately 0.1  $\mu$ F between  $V_{CC}$  and  $V_{SS}$  pins near this device.

- Mode pin (MOD)

Connect the mode pin directly to  $V_{CC}$  or  $V_{SS}$  pins.

To prevent the device unintentionally entering the test mode due to noise, lay out the printed circuit board so as to minimize the distance from the mode pins to  $V_{CC}$  or  $V_{SS}$  pins and to provide a low-impedance connection.

Use a ceramic capacitor or a capacitor with equivalent frequency characteristics. A bypass capacitor of  $V_{CC}$  pin must have a capacitance value higher than  $C_s$ . For connection of smoothing capacitor  $C_s$ , refer to the diagram below.

- C Pin Connection Diagram

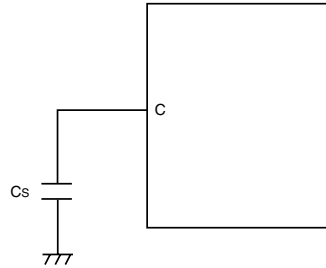

- Analog power supply

Always set the same potential to  $AV_{CC}$  and  $V_{CC}$ . When  $V_{CC} > AV_{CC}$ , the current may flow through the AN00 to AN07 pins.

- NC pins

Any pins marked "NC"(not connected) must be left open.

# MB95130MB Series

## ■ PROGRAMMING FLASH MEMORY MICROCONTROLLERS USING PARALLEL PROGRAMMER

### • Supported parallel programmers and adapters

The following table lists supported parallel programmers and adapters.

Package	Applicable adapter model	Parallel programmers
FPT-28P-M17	TEF110-95F136HSPF	AF9708 (Since Rev 02.43E ) AF9709/B (Since Rev 02.43E )
FPT-30P-M02	TEF110-95F136MB	

Note : For information about applicable adapter models and parallel programmers, contact the following:  
Flash Support Group, Inc. TEL: +81-53-428-8380

### • Sector configuration

The following table shows sector-specific addresses for data access by CPU and by the parallel programmer.

#### • MB95F136MBS/F136NBS/F136MBW/F136NBW/F136JBS/F136JBW (32 Kbytes)

Flash memory	CPU address	Programmer address*
32 Kbytes	8000 <sub>H</sub>	18000 <sub>H</sub>
	FFFF <sub>H</sub>	1FFFF <sub>H</sub>

\*: Programmer addresses are corresponding to CPU addresses, used when the parallel programmer programs data into Flash memory.  
These programmer addresses are used for the parallel programmer to program or erase data in Flash memory.

### • Programming method

- 1) Set the type code of the parallel programmer to "17237".
- 2) Load program data to programmer addresses 18000<sub>H</sub> to 1FFFF<sub>H</sub>.
- 3) Write data with the parallel programmer.

#### • MB95F134MBS/F134NBS/F134JBS/F134MBW/F134NBW/F134JBW (16 Kbytes)

Flash memory	CPU address	Programmer address*
16 Kbytes	C000 <sub>H</sub>	1C000 <sub>H</sub>
	FFFF <sub>H</sub>	1FFFF <sub>H</sub>

\*: Programmer addresses are corresponding to CPU addresses, used when the parallel programmer programs data into Flash memory.  
These programmer addresses are used for the parallel programmer to program or erase data in Flash memory.

### • Programming method

- 1) Set the type code of the parallel programmer to "17237".
- 2) Load program data to programmer addresses 1C000<sub>H</sub> to 1FFFF<sub>H</sub>.
- 3) Write data with the parallel programmer.



- MB95F133MBS/F133NBS/F133JBS/F133MBW/F133NBW/F133JBW (8 Kbytes)

Flash memory	CPU address	Programmer address*
8 Kbytes	E000 <sub>H</sub>	1E000 <sub>H</sub>
	FFFF <sub>H</sub>	1FFFF <sub>H</sub>

\*: Programmer addresses are corresponding to CPU addresses, used when the parallel programmer programs data into Flash memory.

These programmer addresses are used for the parallel programmer to program or erase data in Flash memory.

- **Programming method**

- 1) Set the type code of the parallel programmer to "17237".
- 2) Load program data to programmer addresses 1E000<sub>H</sub> to 1FFFF<sub>H</sub>.
- 3) Write data with the parallel programmer.

# MB95130MB Series

## ■ BLOCK DIAGRAM

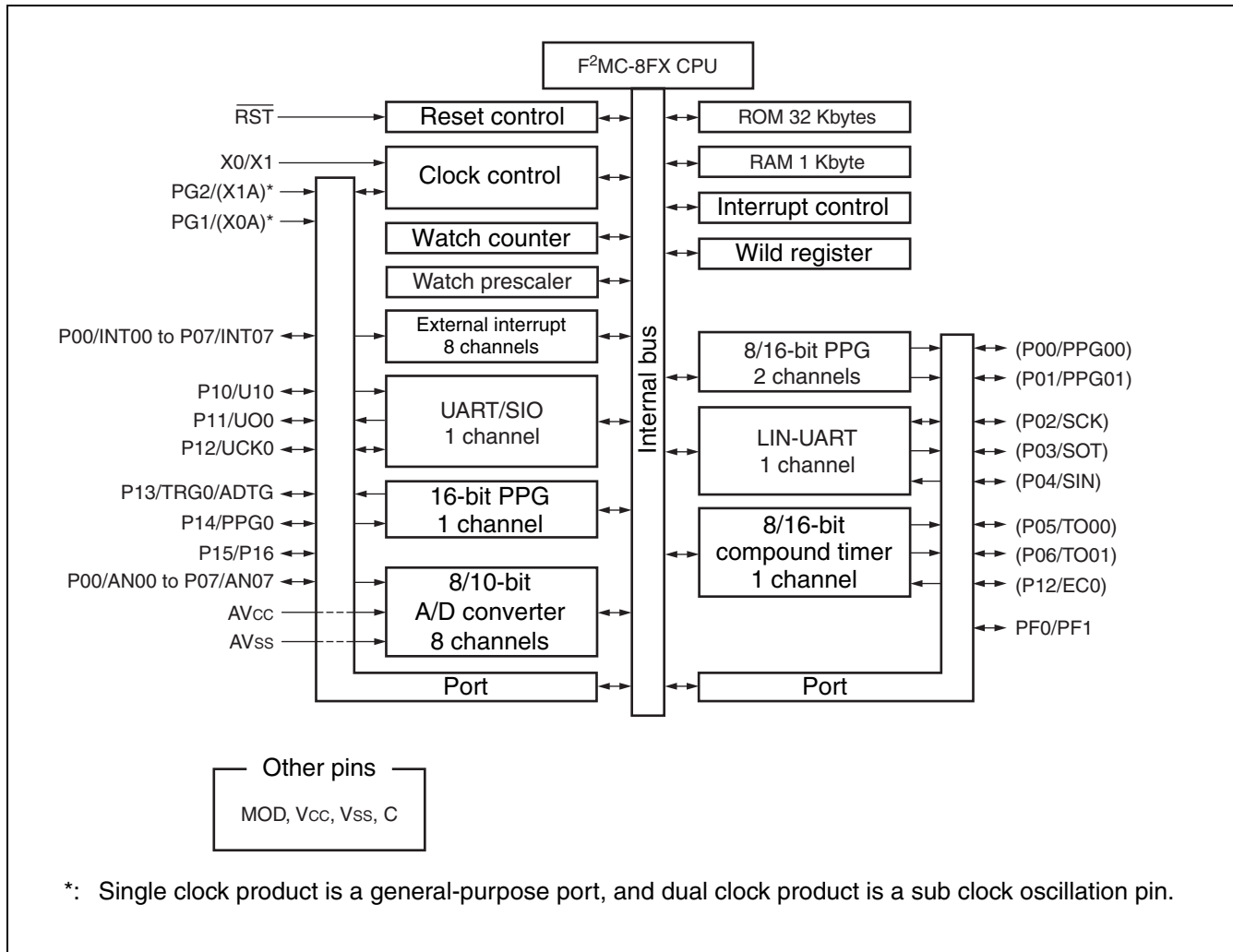

## ■ CPU CORE

### 1. Memory Space

Memory space of the MB95130MB series is 64 Kbytes and consists of I/O area, data area, and program area. The memory space includes special-purpose areas such as the general-purpose registers and vector table. Memory map of the MB95130MB series is shown below.

#### • Memory Map

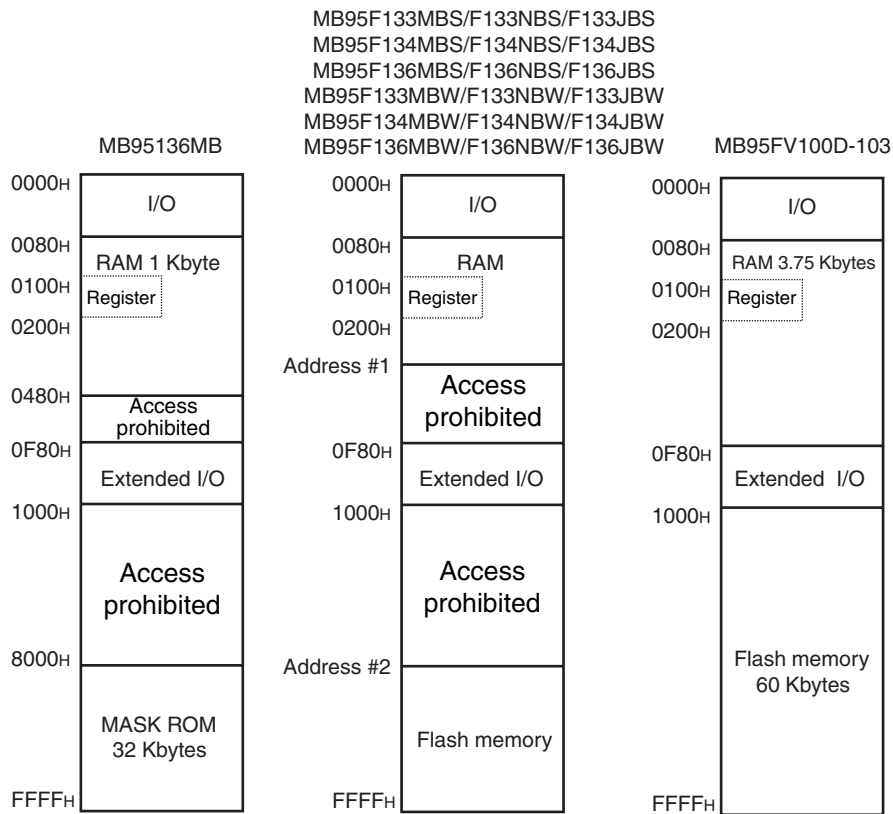

	Flash memory	RAM	Address #1	Address #2
MB95F133MBS/F133NBS/F133JBS	8 Kbytes	256 bytes	0180 <sub>H</sub>	E000 <sub>H</sub>
MB95F133MBW/F133NBW/F133JBW				
MB95F134MBS/F134NBS/F134JBS	16 Kbytes	512 bytes	0280 <sub>H</sub>	C000 <sub>H</sub>
MB95F134MBW/F134NBW/F134JBW				
MB95F136MBS/F136NBS/F136JBS	32 Kbytes	1 Kbyte	0480 <sub>H</sub>	8000 <sub>H</sub>
MB95F136MBW/F136NBW/F136JBW				

# MB95130MB Series

## 2. Register

The MB95130MB series has two types of registers; dedicated registers in the CPU and general-purpose registers in the memory. The dedicated registers are as include:

- Program counter (PC) : A 16-bit register to indicate locations where instructions are stored.
- Accumulator (A) : A 16-bit register for temporary storage of arithmetic operations. In the case of an 8-bit data processing instruction, the lower 1-byte is used.
- Temporary accumulator (T) : A 16-bit register which performs arithmetic operations with the accumulator. In the case of an 8-bit data processing instruction, the lower 1-byte is used.
- Index register (IX) : A 16-bit register for index modification
- Extra pointer (EP) : A 16-bit pointer to point to a memory address.
- Stack pointer (SP) : A 16-bit register to indicate a stack area.
- Program status (PS) : A 16-bit register for storing a register bank pointer, a direct bank pointer, and a condition code register

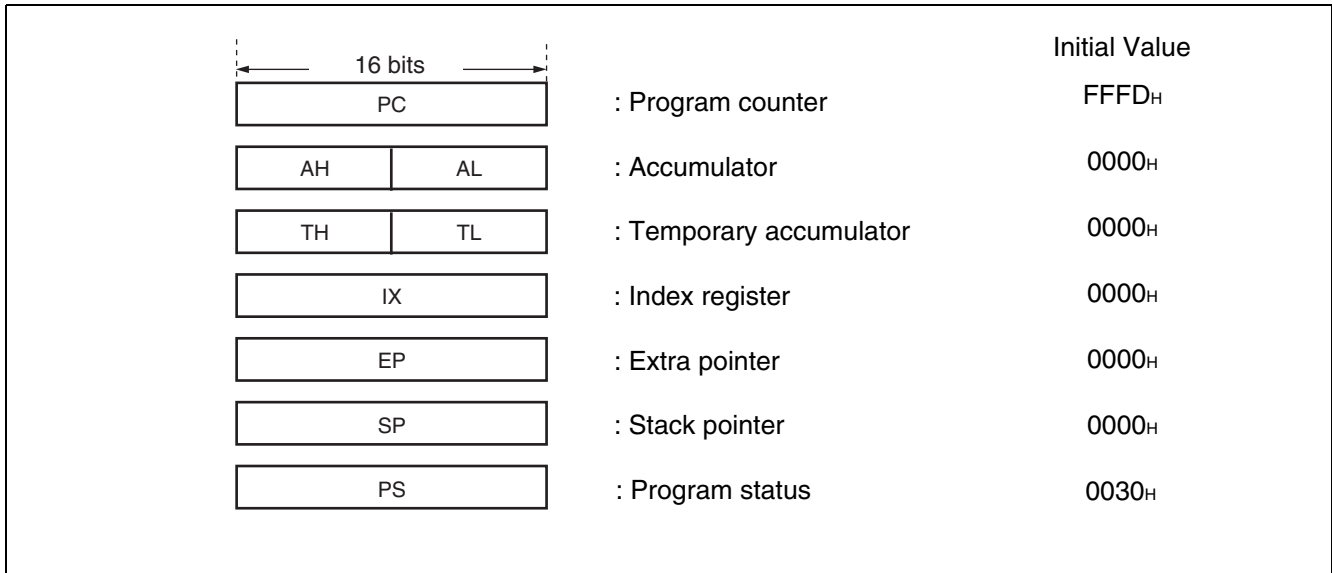

The PS can further be divided into higher 8 bits for use as a register bank pointer (RP) and a direct bank pointer (DP) and the lower 8 bits for use as a condition code register (CCR). (Refer to the diagram below.)

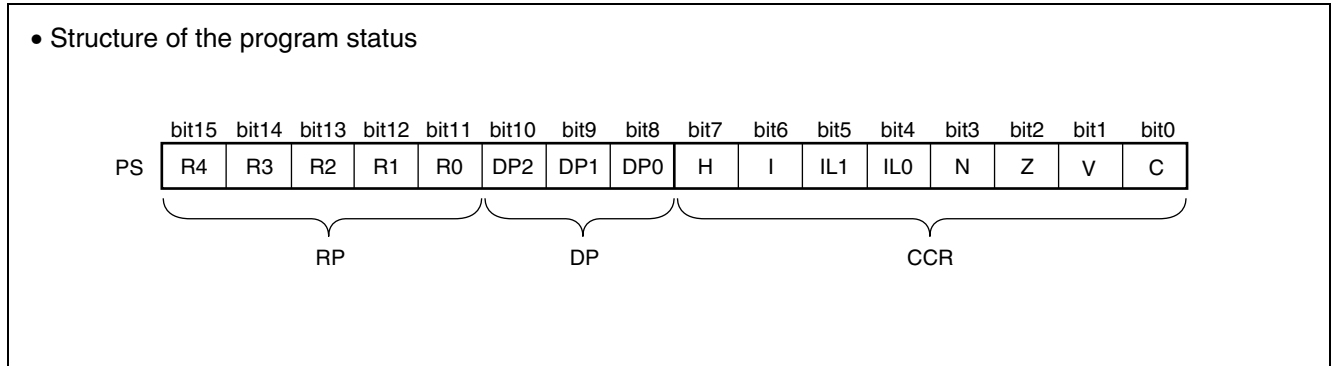

The RP indicates the address of the register bank currently being used. The relationship between the content of RP and the real address conforms to the conversion rule illustrated below:

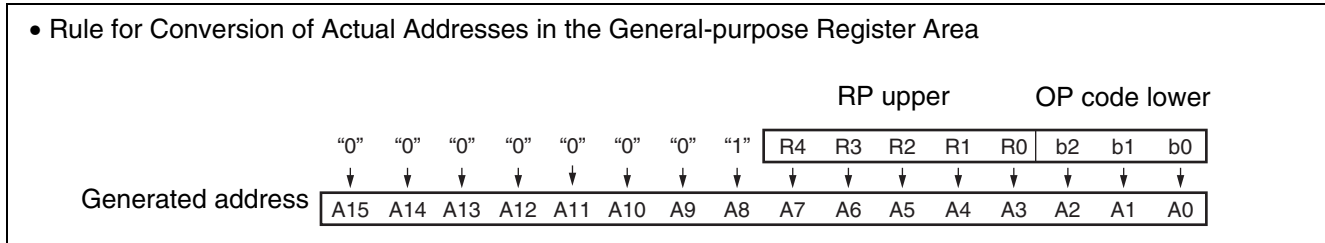

The DP specifies the area for mapping instructions (16 different types of instructions such as MOV A and dir) using direct addresses to 0080H to 00FFH.

Direct bank pointer (DP2 to DP0)	Specified address area	Mapping area
XXX <sub>B</sub> (no effect to mapping)	0000 <sub>H</sub> to 007F <sub>H</sub>	0000 <sub>H</sub> to 007F <sub>H</sub> (without mapping)
000 <sub>B</sub> (initial value)	0080 <sub>H</sub> to 00FF <sub>H</sub>	0080 <sub>H</sub> to 00FF <sub>H</sub> (without mapping)
001 <sub>B</sub>		0100 <sub>H</sub> to 017F <sub>H</sub>
010 <sub>B</sub>		0180 <sub>H</sub> to 01FF <sub>H</sub>
011 <sub>B</sub>		0200 <sub>H</sub> to 027F <sub>H</sub>
100 <sub>B</sub>		0280 <sub>H</sub> to 02FF <sub>H</sub>
101 <sub>B</sub>		0300 <sub>H</sub> to 037F <sub>H</sub>
110 <sub>B</sub>		0380 <sub>H</sub> to 03FF <sub>H</sub>
111 <sub>B</sub>		0400 <sub>H</sub> to 047F <sub>H</sub>

The CCR consists of the bits indicating arithmetic operation results or transfer data content and the bits that control CPU operations at interrupt.

- H flag : Set to "1" when a carry or a borrow from bit 3 to bit 4 occurs as a result of an arithmetic operation. Cleared to "0" otherwise. This flag is for decimal adjustment instructions.
- I flag : Interrupt is enabled when this flag is set to "1". Interrupt is disabled when this flag is set to "0". The flag is cleared to "0" when reset.
- IL1, IL0 : Indicates the level of the interrupt currently enabled. Processes an interrupt only if its request level is higher than the value indicated by these bits.

IL1	IL0	Interrupt level	Priority
0	0	0	High ↑ ↓ Low (no interruption)
0	1	1	
1	0	2	
1	1	3	

- N flag : Set to "1" if the MSB is set to "1" as the result of an arithmetic operation. Cleared to "0" when the bit is set to "0".
- Z flag : Set to "1" when an arithmetic operation results in "0". Cleared to "0" otherwise.
- V flag : Set to "1" if the complement on 2 overflows as a result of an arithmetic operation. Cleared to "0" otherwise.
- C flag : Set to "1" when a carry or a borrow from bit 7 occurs as a result of an arithmetic operation. Cleared to "0" otherwise. Set to the shift-out value in the case of a shift instruction.

# MB95130MB Series

The following general-purpose registers are provided:

General-purpose registers: 8-bit data storage registers

The general-purpose registers are 8 bits and located in the register banks on the memory. 1-bank contains 8 registers. Up to a total of 32 banks can be used on the MB95130MB series. The bank currently in use is specified by the register bank pointer (RP), and the lower 3 bits of OP code indicates the general-purpose register 0 (R0) to general-purpose register 7 (R7).

- Register Bank Configuration

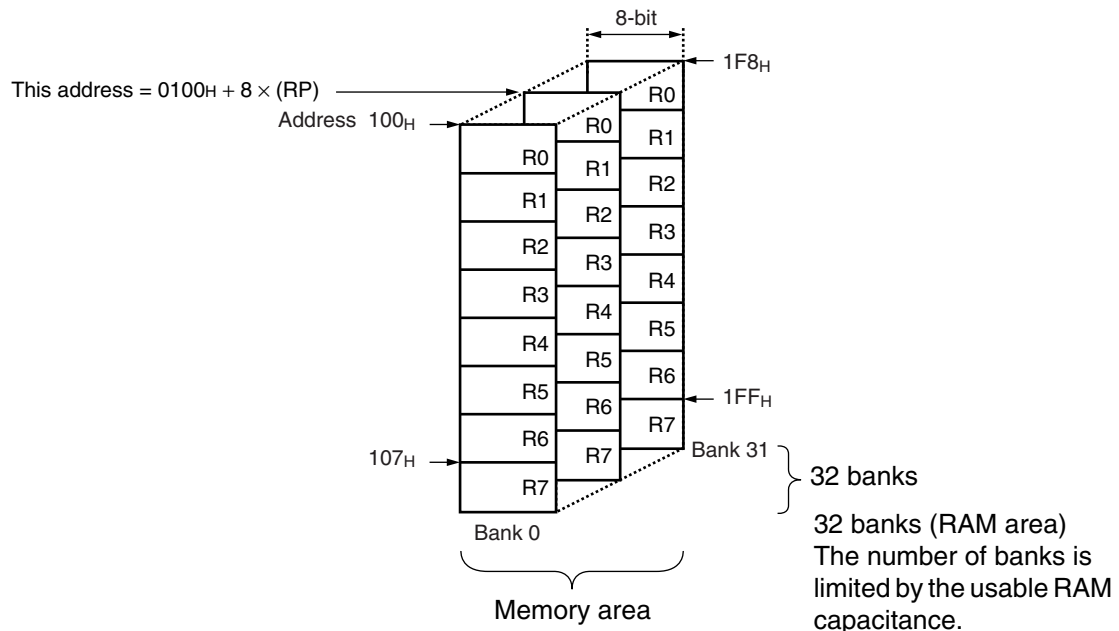

## ■ I/O MAP

Address	Register abbreviation	Register name	R/W	Initial value
0000 <sub>H</sub>	PDR0	Port 0 data register	R/W	00000000 <sub>B</sub>
0001 <sub>H</sub>	DDR0	Port 0 direction register	R/W	00000000 <sub>B</sub>
0002 <sub>H</sub>	PDR1	Port 1 data register	R/W	00000000 <sub>B</sub>
0003 <sub>H</sub>	DDR1	Port 1 direction register	R/W	00000000 <sub>B</sub>
0004 <sub>H</sub>	—	(Disabled)	—	—
0005 <sub>H</sub>	WATR	Oscillation stabilization wait time setting register	R/W	11111111 <sub>B</sub>
0006 <sub>H</sub>	PLLC	PLL control register	R/W	00000000 <sub>B</sub>
0007 <sub>H</sub>	SYCC	System clock control register	R/W	1010X011 <sub>B</sub>
0008 <sub>H</sub>	STBC	Standby control register	R/W	00000000 <sub>B</sub>
0009 <sub>H</sub>	RSRR	Reset source register	R/W	XXXXXXXX <sub>B</sub>
000A <sub>H</sub>	TBTC	Timebase timer control register	R/W	00000000 <sub>B</sub>
000B <sub>H</sub>	WPCR	Watch prescaler control register	R/W	00000000 <sub>B</sub>
000C <sub>H</sub>	WDTC	Watchdog timer control register	R/W	00000000 <sub>B</sub>
000D <sub>H</sub> to 0027 <sub>H</sub>	—	(Disabled)	—	—
0028 <sub>H</sub>	PDRF	Port F data register	R/W	00000000 <sub>B</sub>
0029 <sub>H</sub>	DDRF	Port F direction register	R/W	00000000 <sub>B</sub>
002A <sub>H</sub>	PDRG	Port G data register	R/W	00000000 <sub>B</sub>
002B <sub>H</sub>	DDRG	Port G direction register	R/W	00000000 <sub>B</sub>
002C <sub>H</sub>	PUL0	Port 0 pull-up register	R/W	00000000 <sub>B</sub>
002D <sub>H</sub>	PUL1	Port 1 pull-up register	R/W	00000000 <sub>B</sub>
002E <sub>H</sub> to 0034 <sub>H</sub>	—	(Disabled)	—	—
0035 <sub>H</sub>	PULG	Port G pull-up register	R/W	00000000 <sub>B</sub>
0036 <sub>H</sub>	T01CR1	8/16-bit compound timer 01 control status register 1 ch.0	R/W	00000000 <sub>B</sub>
0037 <sub>H</sub>	T00CR1	8/16-bit compound timer 00 control status register 1 ch.0	R/W	00000000 <sub>B</sub>
0038 <sub>H</sub> , 0039 <sub>H</sub>	—	(Disabled)	—	—
003A <sub>H</sub>	PC01	8/16-bit PPG1 control register ch.0	R/W	00000000 <sub>B</sub>
003B <sub>H</sub>	PC00	8/16-bit PPG0 control register ch.0	R/W	00000000 <sub>B</sub>
003C <sub>H</sub> to 0041 <sub>H</sub>	—	(Disabled)	—	—
0042 <sub>H</sub>	PCNTH0	16-bit PPG control status register (Upper byte) ch.0	R/W	00000000 <sub>B</sub>
0043 <sub>H</sub>	PCNTL0	16-bit PPG control status register (Lower byte) ch.0	R/W	00000000 <sub>B</sub>

(Continued)

# MB95130MB Series

Address	Register abbreviation	Register name	R/W	Initial value
0044 <sub>H</sub> to 0047 <sub>H</sub>	—	(Disabled)	—	—
0048 <sub>H</sub>	EIC00	External interrupt circuit control register ch.0,ch.1	R/W	00000000 <sub>B</sub>
0049 <sub>H</sub>	EIC10	External interrupt circuit control register ch.2,ch.3	R/W	00000000 <sub>B</sub>
004A <sub>H</sub>	EIC20	External interrupt circuit control register ch.4,ch.5	R/W	00000000 <sub>B</sub>
004B <sub>H</sub>	EIC30	External interrupt circuit control register ch.6,ch.7	R/W	00000000 <sub>B</sub>
004C <sub>H</sub> to 004F <sub>H</sub>	—	(Disabled)	—	—
0050 <sub>H</sub>	SCR	LIN-UART serial control register	R/W	00000000 <sub>B</sub>
0051 <sub>H</sub>	SMR	LIN-UART serial mode register	R/W	00000000 <sub>B</sub>
0052 <sub>H</sub>	SSR	LIN-UART serial status register	R/W	00001000 <sub>B</sub>
0053 <sub>H</sub>	RDR/TDR	LIN-UART reception/transmission data register	R/W	00000000 <sub>B</sub>
0054 <sub>H</sub>	ESCR	LIN-UART extended status control register	R/W	00000100 <sub>B</sub>
0055 <sub>H</sub>	ECCR	LIN-UART extended communication control register	R/W	000000XX <sub>B</sub>
0056 <sub>H</sub>	SMC10	UART/SIO serial mode control register 1 ch.0	R/W	00000000 <sub>B</sub>
0057 <sub>H</sub>	SMC20	UART/SIO serial mode control register 2 ch.0	R/W	00100000 <sub>B</sub>
0058 <sub>H</sub>	SSR0	UART/SIO serial status register ch.0	R/W	00000001 <sub>B</sub>
0059 <sub>H</sub>	TDR0	UART/SIO serial output data register ch.0	R/W	00000000 <sub>B</sub>
005A <sub>H</sub>	RDR0	UART/SIO serial input data register ch.0	R	00000000 <sub>B</sub>
005B <sub>H</sub> to 006B <sub>H</sub>	—	(Disabled)	—	—
006C <sub>H</sub>	ADC1	8/10-bit A/D converter control register 1	R/W	00000000 <sub>B</sub>
006D <sub>H</sub>	ADC2	8/10-bit A/D converter control register 2	R/W	00000000 <sub>B</sub>
006E <sub>H</sub>	ADDH	8/10-bit A/D converter data register (Upper byte)	R/W	00000000 <sub>B</sub>
006F <sub>H</sub>	ADDL	8/10-bit A/D converter data register (Lower byte)	R/W	00000000 <sub>B</sub>
0070 <sub>H</sub>	WCSR	Watch counter status register	R/W	00000000 <sub>B</sub>
0071 <sub>H</sub>	—	(Disabled)	—	—
0072 <sub>H</sub>	FSR	Flash memory status register	R/W	000X0000 <sub>B</sub>
0073 <sub>H</sub>	SWRE0	Flash memory sector writing control register 0	R/W	00000000 <sub>B</sub>
0074 <sub>H</sub>	SWRE1	Flash memory sector writing control register 1	R/W	00000000 <sub>B</sub>
0075 <sub>H</sub>	—	(Disabled)	—	—
0076 <sub>H</sub>	WREN	Wild register address compare enable register	R/W	00000000 <sub>B</sub>
0077 <sub>H</sub>	WROR	Wild register data test setting register	R/W	00000000 <sub>B</sub>

(Continued)



# MB95130MB Series

Address	Register abbreviation	Register name	R/W	Initial value
0078 <sub>H</sub>	—	(Register bank pointer (RP) Mirror of direct bank pointer (DP))	—	—
0079 <sub>H</sub>	ILR0	Interrupt level setting register 0	R/W	11111111 <sub>B</sub>
007A <sub>H</sub>	ILR1	Interrupt level setting register 1	R/W	11111111 <sub>B</sub>
007B <sub>H</sub>	ILR2	Interrupt level setting register 2	R/W	11111111 <sub>B</sub>
007C <sub>H</sub>	ILR3	Interrupt level setting register 3	R/W	11111111 <sub>B</sub>
007D <sub>H</sub>	ILR4	Interrupt level setting register 4	R/W	11111111 <sub>B</sub>
007E <sub>H</sub>	ILR5	Interrupt level setting register 5	R/W	11111111 <sub>B</sub>
007F <sub>H</sub>	—	(Disabled)	—	—
0F80 <sub>H</sub>	WRARH0	Wild register address setting register (Upper byte) ch.0	R/W	00000000 <sub>B</sub>
0F81 <sub>H</sub>	WRARL0	Wild register address setting register (Lower byte) ch.0	R/W	00000000 <sub>B</sub>
0F82 <sub>H</sub>	WRDR0	Wild register data setting register ch.0	R/W	00000000 <sub>B</sub>
0F83 <sub>H</sub>	WRARH1	Wild register address setting register (Upper byte) ch.1	R/W	00000000 <sub>B</sub>
0F84 <sub>H</sub>	WRARL1	Wild register address setting register (Lower byte) ch.1	R/W	00000000 <sub>B</sub>
0F85 <sub>H</sub>	WRDR1	Wild register data setting register ch.1	R/W	00000000 <sub>B</sub>
0F86 <sub>H</sub>	WRARH2	Wild register address setting register (Upper byte) ch.2	R/W	00000000 <sub>B</sub>
0F87 <sub>H</sub>	WRARL2	Wild register address setting register (Lower byte) ch.2	R/W	00000000 <sub>B</sub>
0F88 <sub>H</sub>	WRDR2	Wild register data setting register ch.2	R/W	00000000 <sub>B</sub>
0F89 <sub>H</sub> to 0F91 <sub>H</sub>	—	(Disabled)	—	—
0F92 <sub>H</sub>	T01CR0	8/16-bit compound timer 01 control status register 0 ch.0	R/W	00000000 <sub>B</sub>
0F93 <sub>H</sub>	T00CR0	8/16-bit compound timer 00 control status register 0 ch.0	R/W	00000000 <sub>B</sub>
0F94 <sub>H</sub>	T01DR	8/16-bit compound timer 01 data register ch.0	R/W	00000000 <sub>B</sub>
0F95 <sub>H</sub>	T00DR	8/16-bit compound timer 00 data register ch.0	R/W	00000000 <sub>B</sub>
0F96 <sub>H</sub>	TMCR0	8/16-bit compound timer 00/01 timer mode control register ch.0	R/W	00000000 <sub>B</sub>
0F97 <sub>H</sub> to 0F9B <sub>H</sub>	—	(Disabled)	—	—
0F9C <sub>H</sub>	PPS01	8/16-bit PPG1 cycle setting buffer register ch.0	R/W	11111111 <sub>B</sub>
0F9D <sub>H</sub>	PPS00	8/16-bit PPG0 cycle setting buffer register ch.0	R/W	11111111 <sub>B</sub>
0F9E <sub>H</sub>	PDS01	8/16-bit PPG1 duty setting buffer register ch.0	R/W	11111111 <sub>B</sub>
0F9F <sub>H</sub>	PDS00	8/16-bit PPG0 duty setting buffer register ch.0	R/W	11111111 <sub>B</sub>
0FA0 <sub>H</sub> to 0FA3 <sub>H</sub>	—	(Disabled)	—	—

(Continued)

# MB95130MB Series

(Continued)

Address	Register abbreviation	Register name	R/W	Initial value
0FA4 <sub>H</sub>	PPGS	8/16-bit PPG start register	R/W	00000000 <sub>B</sub>
0FA5 <sub>H</sub>	REVC	8/16-bit PPG output inversion register	R/W	00000000 <sub>B</sub>
0FA6 <sub>H</sub> to 0FA9 <sub>H</sub>	—	(Disabled)	—	—
0FAA <sub>H</sub>	PDCRH0	16-bit PPG down counter register (Upper byte) ch.0	R	00000000 <sub>B</sub>
0FAB <sub>H</sub>	PDCRL0	16-bit PPG down counter register (Lower byte) ch.0	R	00000000 <sub>B</sub>
0FAC <sub>H</sub>	PCSRH0	16-bit PPG cycle setting buffer register (Upper byte) ch.0	R/W	11111111 <sub>B</sub>
0FAD <sub>H</sub>	PCSRL0	16-bit PPG cycle setting buffer register (Lower byte) ch.0	R/W	11111111 <sub>B</sub>
0FAE <sub>H</sub>	PDUTH0	16-bit PPG duty setting buffer register (Upper byte) ch.0	R/W	11111111 <sub>B</sub>
0FAF <sub>H</sub>	PDUTL0	16-bit PPG duty setting buffer register (Lower byte) ch.0	R/W	11111111 <sub>B</sub>
0FB0 <sub>H</sub> to 0FBB <sub>H</sub>	—	(Disabled)	—	—
0FBC <sub>H</sub>	BGR1	LIN-UART baud rate generator register 1	R/W	00000000 <sub>B</sub>
0FBD <sub>H</sub>	BGR0	LIN-UART baud rate generator register 0	R/W	00000000 <sub>B</sub>
0FBE <sub>H</sub>	PSSR0	UART/SIO dedicated baud rate generator prescaler selection register ch.0	R/W	00000000 <sub>B</sub>
0FBF <sub>H</sub>	BRSR0	UART/SIO dedicated baud rate generator baud rate setting register ch.0	R/W	00000000 <sub>B</sub>
0FC0 <sub>H</sub> to 0FC2 <sub>H</sub>	—	(Disabled)	—	—
0FC3 <sub>H</sub>	AIDRL	A/D input disable register (Lower byte)	R/W	00000000 <sub>B</sub>
0FC4 <sub>H</sub> to 0FE2 <sub>H</sub>	—	(Disabled)	—	—
0FE3 <sub>H</sub>	WCDR	Watch counter data register	R/W	00111111 <sub>B</sub>
0FE4 <sub>H</sub> to 0FE6 <sub>H</sub>	—	(Disabled)	—	—
0FE7 <sub>H</sub>	ILSR2	Input level select register 2 (option)	R/W	00000000 <sub>B</sub>
0FE8 <sub>H</sub> , 0FE9 <sub>H</sub>	—	(Disabled)	—	—
0FEA <sub>H</sub>	CSVCR	Clock supervisor control register	R/W	00011100 <sub>B</sub>
0FEB <sub>H</sub> to 0FED <sub>H</sub>	—	(Disabled)	—	—
0FEE <sub>H</sub>	ILSR	Input level select register	R/W	00000000 <sub>B</sub>
0FEF <sub>H</sub>	WICR	Interrupt pin control register	R/W	01000000 <sub>B</sub>
0FF0 <sub>H</sub> to 0FFF <sub>H</sub>	—	(Disabled)	—	—

- R/W access symbols
  - R/W : Readable / Writable
  - R : Read only
  - W : Write only
- Initial value symbols
  - 0 : The initial value of this bit is "0".
  - 1 : The initial value of this bit is "1".
  - X : The initial value of this bit is undefined.

Note : Do not write to the " (Disabled) ". Reading the " (Disabled) " returns an undefined value.

# MB95130MB Series

## ■ INTERRUPT SOURCE TABLE

Interrupt source	Interrupt request number	Vector table address		Bit name of interrupt level setting register	Same level priority order (at simultaneous occurrence)
		Upper	Lower		
External interrupt ch.0	IRQ0	FFFA <sub>H</sub>	FFFB <sub>H</sub>	L00 [1 : 0]	<div style="display: flex; align-items: center; justify-content: center;"> <div style="margin-right: 10px;">High</div> <div style="border-left: 1px solid black; border-right: 1px solid black; height: 100%; position: relative;"> <div style="position: absolute; top: -5px; left: 50%; transform: translate(-50%, -50%);">↑</div> <div style="position: absolute; bottom: -5px; left: 50%; transform: translate(-50%, -50%);">↓</div> </div> <div style="margin-left: 10px;">Low</div> </div>
External interrupt ch.4					
External interrupt ch.1	IRQ1	FFF8 <sub>H</sub>	FFF9 <sub>H</sub>	L01 [1 : 0]	
External interrupt ch.5					
External interrupt ch.2	IRQ2	FFF6 <sub>H</sub>	FFF7 <sub>H</sub>	L02 [1 : 0]	
External interrupt ch.6					
External interrupt ch.3	IRQ3	FFF4 <sub>H</sub>	FFF5 <sub>H</sub>	L03 [1 : 0]	
External interrupt ch.7					
UART/SIO ch.0	IRQ4	FFF2 <sub>H</sub>	FFF3 <sub>H</sub>	L04 [1 : 0]	
8/16-bit compound timer ch.0 (Lower)	IRQ5	FFF0 <sub>H</sub>	FFF1 <sub>H</sub>	L05 [1 : 0]	
8/16-bit compound timer ch.0 (Higher)	IRQ6	FFEE <sub>H</sub>	FFEF <sub>H</sub>	L06 [1 : 0]	
LIN-UART (reception)	IRQ7	FFEC <sub>H</sub>	FFED <sub>H</sub>	L07 [1 : 0]	
LIN-UART (transmission)	IRQ8	FFEA <sub>H</sub>	FFEB <sub>H</sub>	L08 [1 : 0]	
(Unused)	IRQ9	FFE8 <sub>H</sub>	FFE9 <sub>H</sub>	L09 [1 : 0]	
(Unused)	IRQ10	FFE6 <sub>H</sub>	FFE7 <sub>H</sub>	L10 [1 : 0]	
(Unused)	IRQ11	FFE4 <sub>H</sub>	FFE5 <sub>H</sub>	L11 [1 : 0]	
8/16-bit PPG ch.0 (Upper)	IRQ12	FFE2 <sub>H</sub>	FFE3 <sub>H</sub>	L12 [1 : 0]	
8/16-bit PPG ch.0 (Lower)	IRQ13	FFE0 <sub>H</sub>	FFE1 <sub>H</sub>	L13 [1 : 0]	
(Unused)	IRQ14	FFDE <sub>H</sub>	FFDF <sub>H</sub>	L14 [1 : 0]	
16-bit PPG ch.0	IRQ15	FFDC <sub>H</sub>	FFDD <sub>H</sub>	L15 [1 : 0]	
(Unused)	IRQ16	FFDA <sub>H</sub>	FFDB <sub>H</sub>	L16 [1 : 0]	
(Unused)	IRQ17	FFD8 <sub>H</sub>	FFD9 <sub>H</sub>	L17 [1 : 0]	
8/10-bit A/D converter	IRQ18	FFD6 <sub>H</sub>	FFD7 <sub>H</sub>	L18 [1 : 0]	
Timebase timer	IRQ19	FFD4 <sub>H</sub>	FFD5 <sub>H</sub>	L19 [1 : 0]	
Watch prescaler/Watch counter	IRQ20	FFD2 <sub>H</sub>	FFD3 <sub>H</sub>	L20 [1 : 0]	
(Unused)	IRQ21	FFD0 <sub>H</sub>	FFD1 <sub>H</sub>	L21 [1 : 0]	
(Unused)	IRQ22	FFCE <sub>H</sub>	FFCF <sub>H</sub>	L22 [1 : 0]	
Flash memory	IRQ23	FFCC <sub>H</sub>	FFCD <sub>H</sub>	L23 [1 : 0]	

## ■ ELECTRICAL CHARACTERISTICS

### 1. Absolute Maximum Ratings

Parameter	Symbol	Rating		Unit	Remarks
		Min	Max		
Power supply voltage*1	$V_{CC}$ $AV_{CC}$	$V_{SS} - 0.3$	$V_{SS} + 6.0$	V	*2
Input voltage*1	$V_I$	$V_{SS} - 0.3$	$V_{SS} + 6.0$	V	*3
Output voltage*1	$V_O$	$V_{SS} - 0.3$	$V_{SS} + 6.0$	V	*3
Maximum clamp current	$I_{CLAMP}$	- 2.0	+ 2.0	mA	Applicable to pins*4
Total maximum clamp current	$\Sigma I_{CLAMP}$	—	20	mA	Applicable to pins*4
“L” level maximum output current	$I_{OL1}$	—	15	mA	Other than PF0, PF1
	$I_{OL2}$		15		PF0, PF1
“L” level average current	$I_{OLAV1}$	—	4	mA	Other than PF0, PF1 Average output current = operating current × operating ratio (1 pin)
	$I_{OLAV2}$		12		PF0, PF1 Average output current = operating current × operating ratio (1 pin)
“L” level total maximum output current	$\Sigma I_{OL}$	—	100	mA	
“L” level total average output current	$\Sigma I_{OLAV}$	—	50	mA	Total average output current = operating current × operating ratio (Total of pins)
“H” level maximum output current	$I_{OH1}$	—	- 15	mA	Other than PF0, PF1
	$I_{OH2}$		- 15		PF0, PF1
“H” level average current	$I_{OHAV1}$	—	- 4	mA	Other than PF0, PF1 Average output current = operating current × operating ratio (1 pin)
	$I_{OHAV2}$		- 8		PF0, PF1 Average output current = operating current × operating ratio (1 pin)
“H” level total maximum output current	$\Sigma I_{OH}$	—	- 100	mA	
“H” level total average output current	$\Sigma I_{OHAV}$	—	- 50	mA	Total average output current = operating current × operating ratio (Total number of pins)
Power consumption	$P_d$	—	320	mW	
Operating temperature	$T_A$	- 40	+ 85	°C	
Storage temperature	$T_{stg}$	- 55	+ 150	°C	

# MB95130MB Series

- \*1: The parameter is based on  $AV_{SS} = V_{SS} = 0.0\text{ V}$ .
- \*2: Apply equal potential to  $AV_{CC}$  and  $V_{CC}$ .
- \*3:  $V_I$  and  $V_O$  should not exceed  $V_{CC} + 0.3\text{ V}$ .  $V_I$  must not exceed the rating voltage. However, if the maximum current to/from an input is limited by some means with external components, the  $I_{CLAMP}$  rating supersedes the  $V_I$  rating.
- \*4: Applicable pins: P10 to P15, PF0, PF1 (Inapplicable pins: PG1, PG2)
  - Use within recommended operating conditions.
  - Use at DC voltage (current).
  - +B signal is an input signal that exceeds  $V_{CC}$  voltage. The + B signal should always be applied a limiting resistance placed between the + B signal and the microcontroller.
  - The value of the limiting resistance should be set so that when the + B signal is applied the input current to the microcontroller pin does not exceed rated values, either instantaneously or for prolonged periods.
  - Note that when the microcontroller drive current is low, such as in the power saving modes, the +B input potential may pass through the protective diode and increase the potential at the  $V_{CC}$  pin, and this affects other devices.
  - Note that if the + B signal is inputted when the microcontroller power supply is off (not fixed at 0 V), the power supply is provided from the pins, so that incomplete operation may result.
  - Note that if the + B input is applied during power-on, the power supply is provided from the pins and the resulting power supply voltage may not be sufficient to operate the power-on reset.
  - Care must be taken not to leave the + B input pin open.
  - Note that analog system input/output pins other than the A/D input pins (LCD drive pins, etc.) cannot accept +B signal input.
  - Sample recommended circuits :

- Input/Output Equivalent circuits

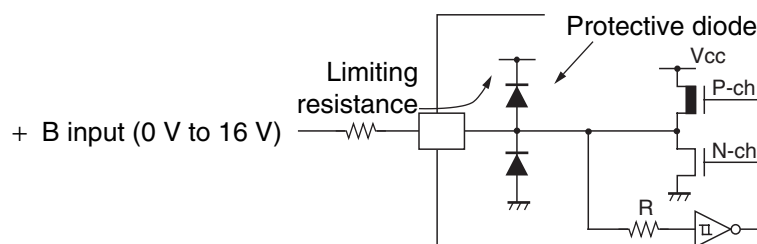

**WARNING:** Semiconductor devices can be permanently damaged by application of stress (voltage, current, temperature, etc.) in excess of absolute maximum ratings. Do not exceed these ratings.

## 2. Recommended Operating Conditions

( $AV_{SS} = V_{SS} = 0.0\text{ V}$ )

Parameter	Symbol	Value		Unit	Remarks
		Min	Max		
Power supply voltage	$V_{CC}, AV_{CC}$	2.42* <sup>2</sup>	5.5* <sup>1</sup>	V	At normal operation
		2.3	5.5		Holds condition in stop mode
Smoothing capacitor	$C_S$	0.1	1.0	$\mu\text{F}$	*3
Operating temperature	$T_A$	- 40	+ 85	$^{\circ}\text{C}$	

\*1: The value varies depending on the operating frequency.

\*2: The value is 2.88 V when the low-voltage detection reset is used.

\*3: Use ceramic capacitor or a capacitor with equivalent frequency characteristics. A bypass capacitor of  $V_{CC}$  pin must have a capacitance value higher than  $C_S$ . For connection of smoothing capacitor  $C_S$ , refer to the diagram below.

• C pin connection diagram

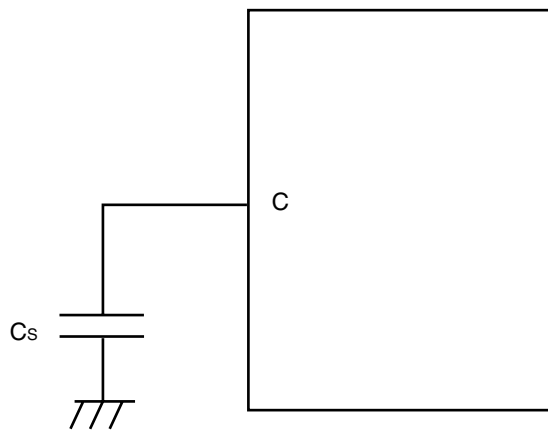

**WARNING:** The recommended operating conditions are required in order to ensure the normal operation of the semiconductor device. All of the device's electrical characteristics are warranted when the device is operated within these ranges.

Always use semiconductor devices within their recommended operating condition ranges. Operation outside these ranges may adversely affect reliability and could result in device failure.

No warranty is made with respect to uses, operating conditions, or combinations not represented on the data sheet. Users considering application outside the listed conditions are advised to contact their FUJITSU representatives beforehand.

# MB95130MB Series

## 3. DC Characteristics

( $V_{CC} = AV_{CC} = 5.0\text{ V} \pm 10\%$ ,  $AV_{SS} = V_{SS} = 0.0\text{ V}$ ,  $T_A = -40\text{ }^\circ\text{C}$  to  $+85\text{ }^\circ\text{C}$ )

Parameter	Symbol	Pin name	Condition	Value			Unit	Remarks
				Min	Typ	Max		
“H” level input voltage	$V_{IHI}$	P04 (selectable in SIN), P10 (selectable in UI0)	—	$0.7 V_{CC}$	—	$V_{CC} + 0.3$	V	Hysteresis input
	$V_{IHSI}$	P00 to P07, P10 to P16, PF0, PF1, PG1, PG2	—	$0.8 V_{CC}$	—	$V_{CC} + 0.3$	V	Hysteresis input
	$V_{IHA}$	P00 to P07, P10 to P16, PF0, PF1, PG1, PG2	—	$0.8 V_{CC}$	—	$V_{CC} + 0.3$	V	Pin input at selecting of Automotive input level
	$V_{IHM}$	$\overline{RST}$ , MOD	—	$0.7 V_{CC}$	—	$V_{CC} + 0.3$	V	CMOS input (Flash memory product)
—			$0.8 V_{CC}$	—	$V_{CC} + 0.3$	V	Hysteresis input (MASK ROM product)	
“L” level input voltage	$V_{IL}$	P04 (selectable in SIN), P10 (selectable in UI0)	—	$V_{SS} - 0.3$	—	$0.3 V_{CC}$	V	Hysteresis input
	$V_{ILS}$	P00 to P07, P10 to P16, PF0, PF1, PG1, PG2	—	$V_{SS} - 0.3$	—	$0.2 V_{CC}$	V	Hysteresis input
	$V_{ILA}$	P00 to P07, P10 to P16, PF0, PF1, PG1, PG2	—	$V_{SS} - 0.3$	—	$0.5 V_{CC}$	V	Pin input at selecting of Automotive input level
	$V_{ILM}$	$\overline{RST}$ , MOD	—	$V_{SS} - 0.3$	—	$0.3 V_{CC}$	V	CMOS input (Flash memory product)
—			$V_{SS} - 0.3$	—	$0.2 V_{CC}$	V	Hysteresis input (MASK ROM product)	
“H” level output voltage	$V_{OH1}$	Output pins other than PF0, PF1	$I_{OH} = -4.0\text{ mA}$	$V_{CC} - 0.5$	—	—	V	
	$V_{OH2}$	PF0, PF1	$I_{OH} = -8.0\text{ mA}$	$V_{CC} - 0.5$	—	—	V	
“L” level output voltage	$V_{OL1}$	Output pins other than PF0 to PF7, $\overline{RST}^{*1}$	$I_{OL} = 4.0\text{ mA}$	—	—	0.4	V	
	$V_{OL2}$	PF0, PF1	$I_{OL} = 12\text{ mA}$	—	—	0.4	V	

(Continued)



# MB95130MB Series

( $V_{CC} = AV_{CC} = 5.0\text{ V} \pm 10\%$ ,  $AV_{SS} = V_{SS} = 0.0\text{ V}$ ,  $T_A = -40\text{ }^\circ\text{C}$  to  $+85\text{ }^\circ\text{C}$ )

Parameter	Symbol	Pin name	Condition	Value			Unit	Remarks
				Min	Typ	Max		
Input leakage current (Hi-Z output leakage current)	$I_{LI}$	P00 to P07, P10 to P16, PF0, PF1, PG1, PG2	$0.0\text{ V} < V_I < V_{CC}$	-5	—	+5	$\mu\text{A}$	When the pull-up prohibition setting
Pull-up resistor	$R_{PULL}$	P00 to P07, P10 to P16, PG1, PG2	$V_I = 0.0\text{ V}$	25	50	100	$\text{k}\Omega$	When the pull-up permission setting
Pull-down resistor	$R_{MOD}$	MOD	$V_I = V_{CC}$	50	100	200	$\text{k}\Omega$	MASK ROM product only
Input capacity	$C_{IN}$	Other than $AV_{CC}$ , $AV_{SS}$ , C, $V_{CC}$ and $V_{SS}$	$f = 1\text{ MHz}$	—	5	15	$\text{pF}$	
Power supply current*2	$I_{CC}$	$V_{CC}$ (External clock operation)	$V_{CC} = 5.5\text{ V}$ $F_{CH} = 20\text{ MHz}$ $F_{MP} = 10\text{ MHz}$ Main clock mode (divided by 2)	—	9.5	12.5	$\text{mA}$	Flash memory product (at other than Flash memory writing and erasing)
				—	30	35	$\text{mA}$	Flash memory product (at Flash memory writing and erasing)
				—	7.2	9.5	$\text{mA}$	MASK ROM product
			$F_{CH} = 32\text{ MHz}$ $F_{MP} = 16\text{ MHz}$ Main clock mode (divided by 2)	—	15.2	20.0	$\text{mA}$	Flash memory product (at other than Flash memory writing and erasing)
				—	35.7	42.5	$\text{mA}$	Flash memory product (at Flash memory writing and erasing)
				—	11.6	15.2	$\text{mA}$	MASK ROM product

(Continued)

# MB95130MB Series

( $V_{CC} = AV_{CC} = 5.0\text{ V} \pm 10\%$ ,  $AV_{SS} = V_{SS} = 0.0\text{ V}$ ,  $T_A = -40\text{ }^\circ\text{C}$  to  $+85\text{ }^\circ\text{C}$ )

Parameter	Symbol	Pin name	Condition	Value			Unit	Remarks
				Min	Typ	Max		
Power supply current*2	I <sub>CCS</sub>	V <sub>CC</sub> (External clock operation)	V <sub>CC</sub> = 5.5 V F <sub>CH</sub> = 20 MHz F <sub>MP</sub> = 10 MHz Main Sleep mode (divided by 2)	—	4.5	7.5	mA	
			F <sub>CH</sub> = 32 MHz F <sub>MP</sub> = 16 MHz Main Sleep mode (divided by 2)	—	7.2	12.0	mA	
	I <sub>CCCL</sub>		V <sub>CC</sub> = 5.5 V F <sub>CL</sub> = 32 kHz F <sub>MPL</sub> = 16 kHz Sub clock mode (divided by 2), T <sub>A</sub> = +25 °C	—	45	100	μA	Dual clock product only
	I <sub>CCLS</sub>		V <sub>CC</sub> = 5.5 V F <sub>CL</sub> = 32 kHz F <sub>MPL</sub> = 16 kHz Sub sleep mode (divided by 2), T <sub>A</sub> = +25 °C	—	10	81	μA	Dual clock product only
	I <sub>CCCT</sub>		V <sub>CC</sub> = 5.5 V F <sub>CL</sub> = 32 kHz Watch mode Main stop mode T <sub>A</sub> = +25 °C	—	4.6	27	μA	Dual clock product only
	I <sub>CCMPLL</sub>		V <sub>CC</sub> = 5.5 V F <sub>CH</sub> = 4 MHz F <sub>MP</sub> = 10 MHz Main PLL mode (multiplied by 2.5)	—	9.3	12.5	mA	Flash memory product
			F <sub>CH</sub> = 6.4 MHz F <sub>MP</sub> = 16 MHz Main PLL mode (multiplied by 2.5)	—	7	9.5	mA	MASK ROM product
			F <sub>CH</sub> = 6.4 MHz F <sub>MP</sub> = 16 MHz Main PLL mode (multiplied by 2.5)	—	14.9	20.0	mA	Flash memory product
			F <sub>CH</sub> = 6.4 MHz F <sub>MP</sub> = 16 MHz Main PLL mode (multiplied by 2.5)	—	11.2	15.2	mA	MASK ROM product
	I <sub>CCSPLL</sub>		V <sub>CC</sub> = 5.5 V F <sub>CL</sub> = 32 kHz F <sub>MPL</sub> = 128 kHz Sub PLL mode (multiplied by 4), T <sub>A</sub> = +25 °C	—	160	400	μA	Dual clock product only

(Continued)

# MB95130MB Series

(Continued)

( $V_{CC} = AV_{CC} = 5.0 \text{ V} \pm 10\%$ ,  $AV_{SS} = V_{SS} = 0.0 \text{ V}$ ,  $T_A = -40 \text{ }^\circ\text{C}$  to  $+85 \text{ }^\circ\text{C}$ )

Parameter	Symbol	Pin name	Condition	Value			Unit	Remarks
				Min	Typ	Max		
Power supply current*2	I <sub>CTS</sub>	V <sub>CC</sub> (External clock operation)	V <sub>CC</sub> = 5.5 V F <sub>CH</sub> = 10 MHz Timebase timer mode T <sub>A</sub> = +25 °C	—	0.15	1.1	mA	
	I <sub>CCH</sub>		V <sub>CC</sub> = 5.5 V Sub stop mode T <sub>A</sub> = +25 °C	—	3.5	20.0	μA	Main stop mode for single clock product
	I <sub>A</sub>	AV <sub>CC</sub>	V <sub>CC</sub> = 5.5 V F <sub>CH</sub> = 16 MHz When A/D conversion is in operation	—	2.4	4.7	mA	
	I <sub>AH</sub>		V <sub>CC</sub> = 5.5 V F <sub>CH</sub> = 16 MHz When A/D conversion is stopped T <sub>A</sub> = +25 °C	—	1	5	μA	

\*1: Product without clock supervisor only

- \*2:
- The power supply current is specified by the external clock. When the low-voltage detection and clock supervisor options are selected, the consumption current values of both the low-voltage detection circuit (I<sub>LVD</sub>) and the built-in CR oscillator (I<sub>CSV</sub>) must also be added to the power supply current value.
  - Refer to “4. AC Characteristics: (1) Clock Timing” for F<sub>CH</sub> and F<sub>CL</sub>.
  - Refer to “4. AC Characteristics: (2) Source Clock/Machine Clock” for F<sub>MP</sub> and F<sub>MPL</sub>.

# MB95130MB Series

## 4. AC Characteristics

### (1) Clock Timing

( $V_{CC} = 2.42 \text{ V to } 5.0 \text{ V}$ ,  $AV_{SS} = V_{SS} = 0.0 \text{ V}$ ,  $T_A = -40 \text{ }^\circ\text{C to } +85 \text{ }^\circ\text{C}$ )

Parameter	Sym- bol	Pin name	Condi- tion	Value			Unit	Remarks
				Min	Typ	Max		
Clock frequency	F <sub>CH</sub>	X0, X1	—	1.00	—	16.25	MHz	When using main oscillation circuit
				1.00	—	32.50	MHz	When using external clock
				3.00	—	10.00	MHz	Main PLL multiplied by 1
				3.00	—	8.13	MHz	Main PLL multiplied by 2
				3.00	—	6.50	MHz	Main PLL multiplied by 2.5
				3.00	—	4.06	MHz	Main PLL multiplied by 4
	F <sub>CL</sub>	X0A, X1A		—	32.768	—	kHz	When using sub oscillation circuit
				—	32.768	—	kHz	When using sub PLL $V_{CC} = 2.3 \text{ V to } 3.6 \text{ V}$
Clock cycle time	t <sub>H CYL</sub>	X0, X1	61.5	—	1000	ns	When using main oscillation circuit	
			30.8	—	1000	ns	When using external clock	
	t <sub>L CYL</sub>	X0A, X1A	—	30.5	—	μs	When using sub oscillation circuit	
Input clock pulse width	t <sub>WH1</sub> t <sub>WL1</sub>	X0	61.5	—	—	ns	When using external clock duty ratio is about 30% to 70%.	
	t <sub>WH2</sub> t <sub>WL2</sub>	X0A	—	15.2	—	μs		
Input clock rise/fall time	t <sub>CR</sub> t <sub>CF</sub>	X0, X0A	—	—	5	ns	When using external clock	

- Input wave form for using external clock (main clock)

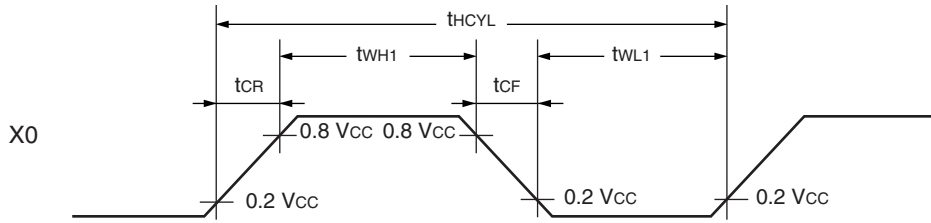

- Figure of Main Clock Input Port External Connection

When using crystal or ceramic oscillator

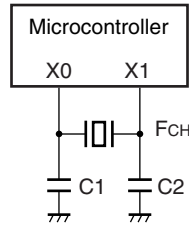

When using external clock

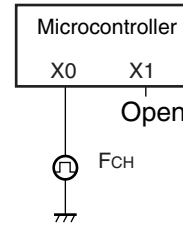

- Input wave form for using external clock (sub clock)

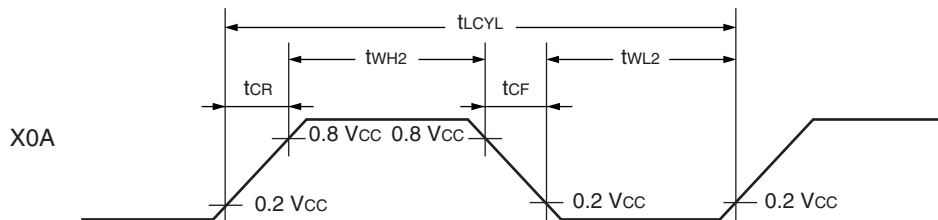

- Figure of Sub clock Input Port External Connection

When using crystal or ceramic oscillator

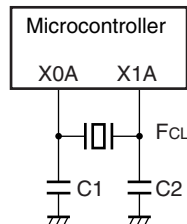

When using external clock

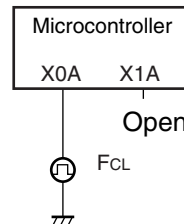

# MB95130MB Series

## (2) Source Clock/Machine Clock

( $V_{CC} = 5.0\text{ V} \pm 10\%$ ,  $AV_{SS} = V_{SS} = 0.0\text{ V}$ ,  $T_A = -40\text{ }^\circ\text{C}$  to  $+85\text{ }^\circ\text{C}$ )

Parameter	Symbol	Pin name	Value			Unit	Remarks
			Min	Typ	Max		
Source clock cycle time* <sup>1</sup> (Clock before setting division)	$t_{SCLK}$	—	61.5	—	2000	ns	When using main clock Min : $F_{CH} = 8.125\text{ MHz}$ , PLL multiplied by 2 Max : $F_{CH} = 1\text{ MHz}$ , divided by 2
			7.6	—	61.0	$\mu\text{s}$	When using sub clock Min : $F_{CL} = 32\text{ kHz}$ , PLL multiplied by 4 Max : $F_{CL} = 32\text{ kHz}$ , divided by 2
Source clock frequency	$F_{SP}$	—	0.50	—	16.25	MHz	When using main clock
	$F_{SPL}$	—	16.384	—	131.072	kHz	When using sub clock
Machine clock cycle time* <sup>2</sup> (Minimum instruction execution time)	$t_{MCLK}$	—	61.5	—	32000	ns	When using main clock Min : $F_{SP} = 16.25\text{ MHz}$ , no division Max : $F_{SP} = 0.5\text{ MHz}$ , divided by 16
			7.6	—	976.5	$\mu\text{s}$	When using sub clock Min : $F_{SPL} = 131\text{ kHz}$ , no division Max : $F_{SPL} = 16\text{ kHz}$ , divided by 16
Machine clock frequency	$F_{MP}$	—	0.031	—	16.250	MHz	When using main clock
	$F_{MPL}$	—	1.024	—	131.072	kHz	When using sub clock

\*1 : Clock before setting division due to machine clock division ratio selection bit (SYCC : DIV1 and DIV0) . This source clock is divided by the machine clock division ratio selection bit (SYCC : DIV1 and DIV0) , and it becomes the machine clock. Further, the source clock can be selected as follows.

- Main clock divided by 2
- PLL multiplication of main clock (select from 1, 2, 2.5, 4 multiplication)
- Sub clock divided by 2
- PLL multiplication of sub clock (select from 2, 3, 4 multiplication)

\*2 : Operation clock of the microcontroller. Machine clock can be selected as follows.

- Source clock (no division)
- Source clock divided by 4
- Source clock divided by 8
- Source clock divided by 16

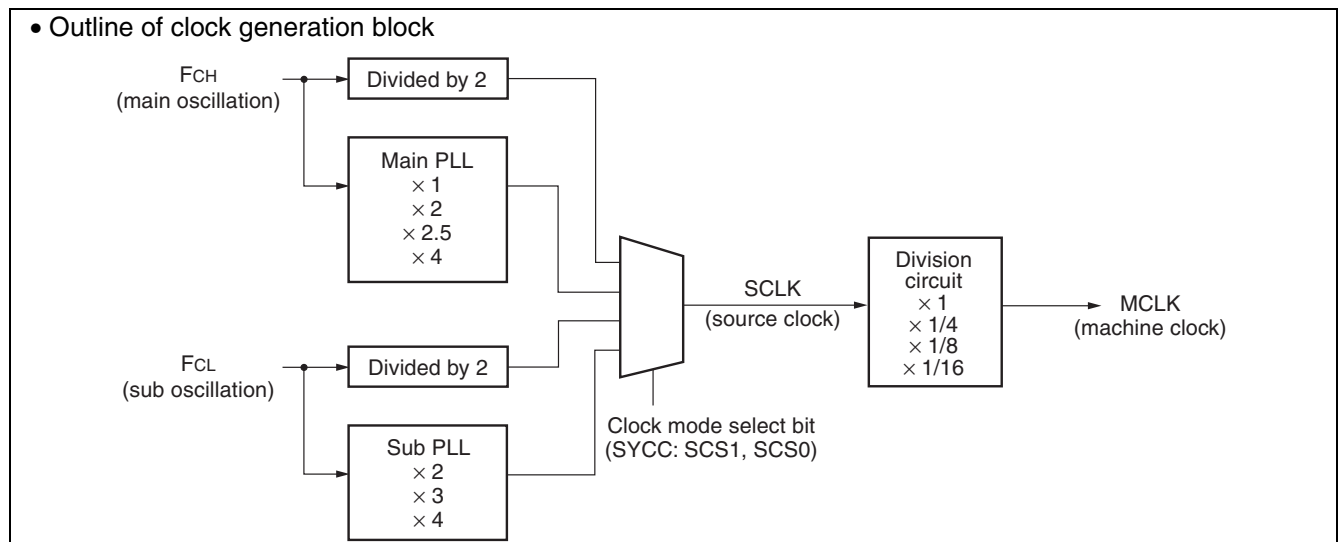

# MB95130MB Series

- Operating voltage - Operating frequency (When  $T_A = -40\text{ }^\circ\text{C}$  to  $+85\text{ }^\circ\text{C}$ )
  - MB95F133MBS/F133NBS/F133JBS/F134MBS/F134NBS/F134JBS/F136MBS/F136NBS/F136JBS/  
MB95F133MBW/F133NBW/F133JBW/F134MBW/F134NBW/F134JBW/F136MBW/F136NBW/  
MB95F136JBW

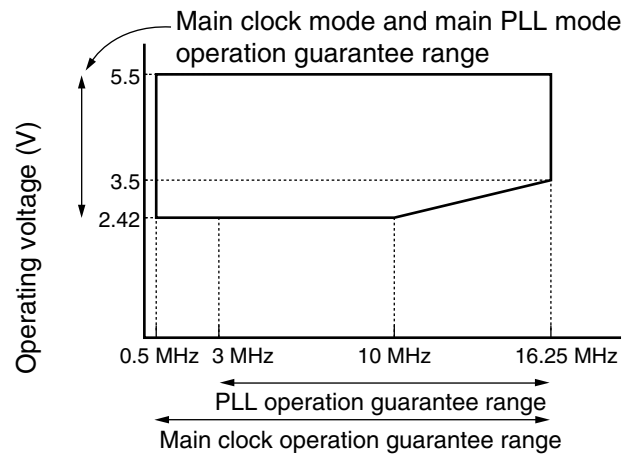
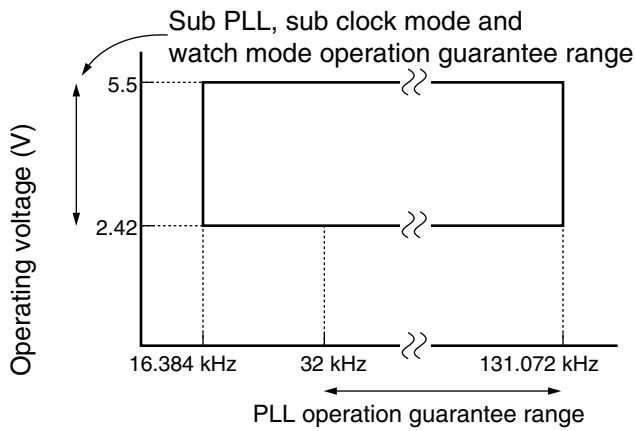

- Operating voltage - Operating frequency (When  $T_A = +5\text{ }^\circ\text{C}$  to  $+35\text{ }^\circ\text{C}$ )
  - MB95FV100D-103

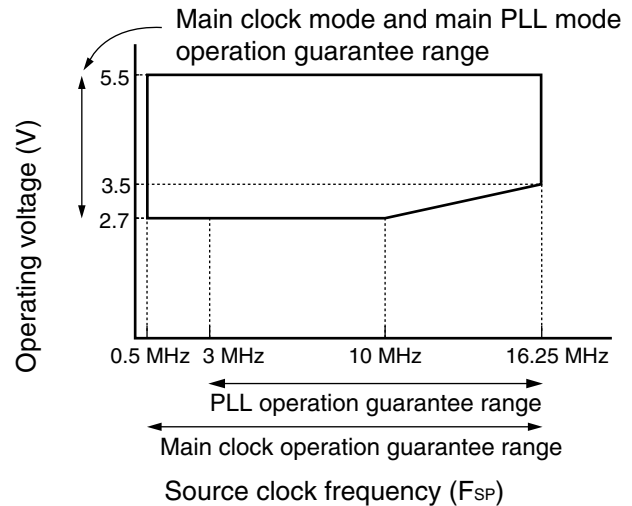
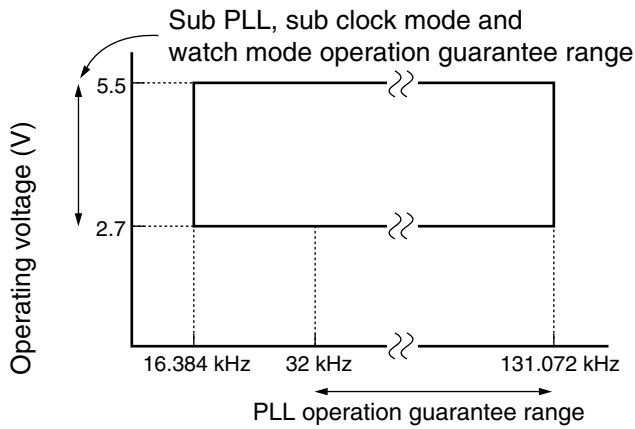

# MB95130MB Series

- Main PLL operation frequency

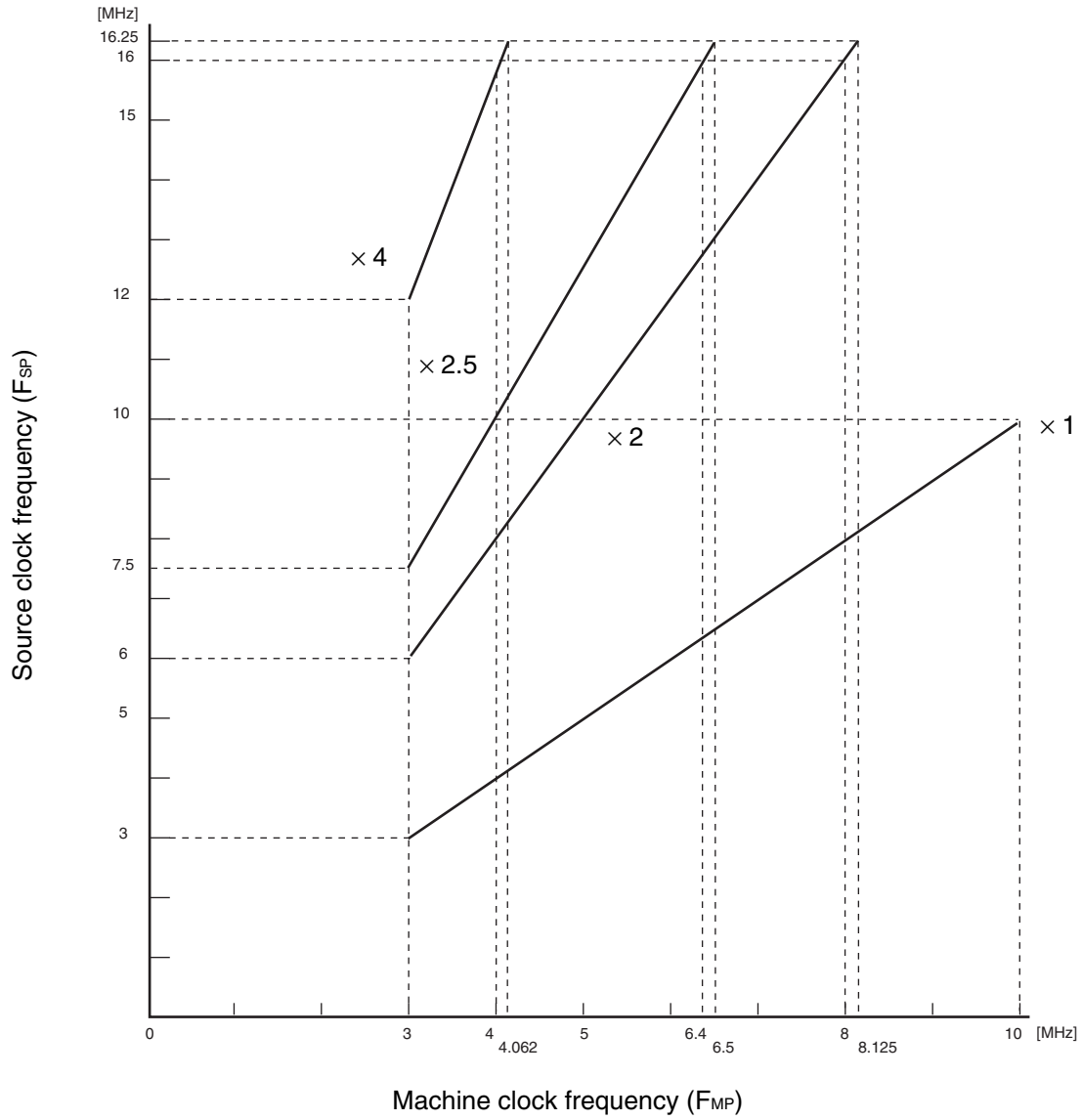



## (3) External Reset

( $V_{CC} = 5.0\text{ V} \pm 10\%$ ,  $AV_{SS} = V_{SS} = 0.0\text{ V}$ ,  $T_A = -40\text{ }^\circ\text{C}$  to  $+85\text{ }^\circ\text{C}$ )

Parameter	Symbol	Pin name	Value		Unit	Remarks
			Min	Max		
$\overline{\text{RST}}$ "L" level pulse width	$t_{\text{RSTL}}$	$\overline{\text{RST}}$	$2 t_{\text{MCLK}}^{*1}$	—	ns	At normal operation
			Oscillation time of oscillator <sup>*2</sup> + 100	—	$\mu\text{s}$	At stop mode, sub clock mode, sub sleep mode & watch mode
			100	—	$\mu\text{s}$	At timebase timer mode

\*1 : Refer to "(2) Source Clock/Machine Clock" for  $t_{\text{MCLK}}$ .

\*2 : Oscillation start time of oscillator is the time that the amplitude reaches 90 %. In the crystal oscillator, the oscillation time is between several ms and tens of ms. In ceramic oscillators, the oscillation time is between hundreds of  $\mu\text{s}$  and several ms. In the external clock, the oscillation time is 0 ms.

- At normal operation

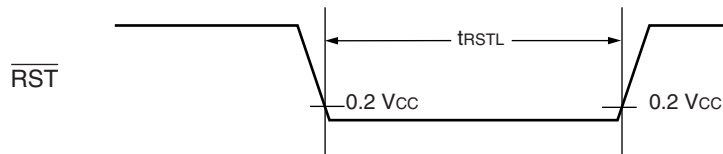

- At stop mode, sub clock mode, sub sleep mode, watch mode, and power-on

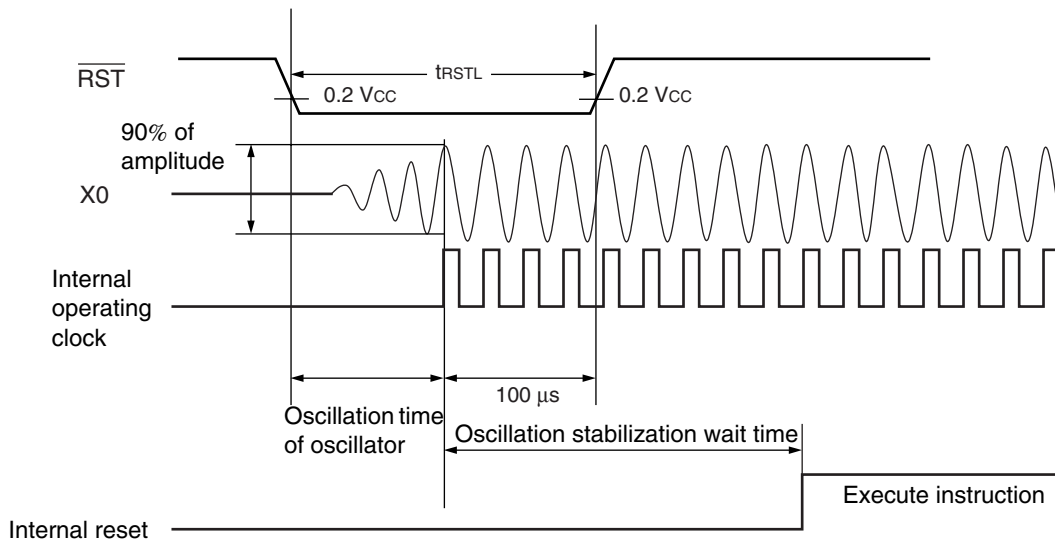

# MB95130MB Series

## (4) Power-on Reset

( $A_{V_{SS}} = V_{SS} = 0.0 \text{ V}$ ,  $T_A = -40 \text{ }^\circ\text{C}$  to  $+85 \text{ }^\circ\text{C}$ )

Parameter	Symbol	Pin name	Condition	Value		Unit	Remarks
				Min	Max		
Power supply rising time	$t_R$	$V_{CC}$	—	—	50	ms	
Power supply cutoff time	$t_{OFF}$		—	1	—	ms	Waiting time until power-on

Note : Complete the power-on process within the selected oscillation stabilization wait time.

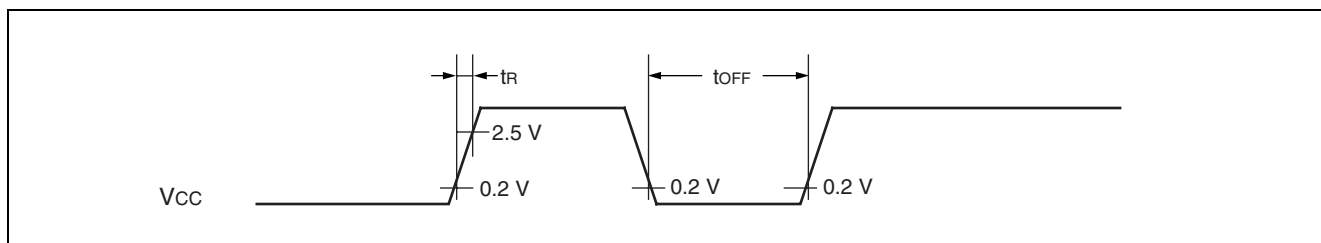

Note : Sudden change of power supply voltage may activate the power-on reset function. When changing power supply voltages during operation, set the slope of rising within 30 mV/ms as shown below.

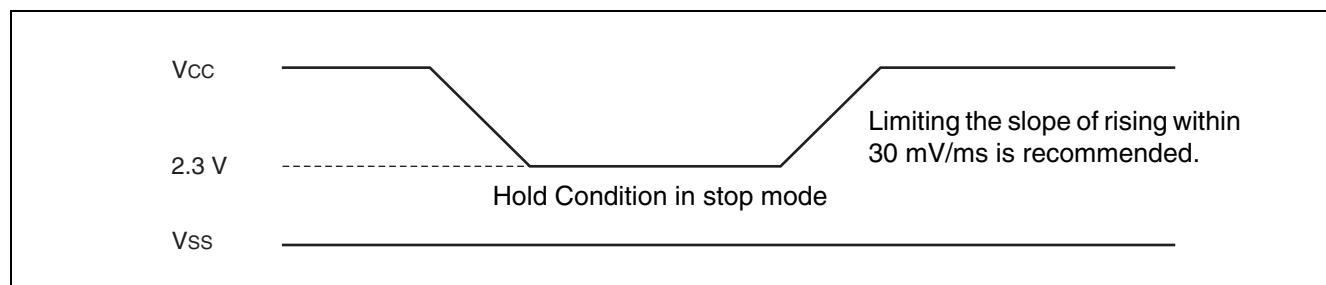

## (5) Peripheral Input Timing

( $V_{CC} = 5.0\text{ V} \pm 10\%$ ,  $AV_{SS} = V_{SS} = 0.0\text{ V}$ ,  $T_A = -40\text{ }^\circ\text{C}$  to  $+85\text{ }^\circ\text{C}$ )

Parameter	Symbol	Pin name	Value		Unit
			Min	Max	
Peripheral input "H" pulse	$t_{LIH}$	INT00 to INT07, EC0, TRG0/ADTG	$2 t_{MCLK}^*$	—	ns
Peripheral input "L" pulse	$t_{LIL}$		$2 t_{MCLK}^*$	—	ns

\* : Refer to "(2) Source Clock/Machine Clock" for  $t_{MCLK}$ .

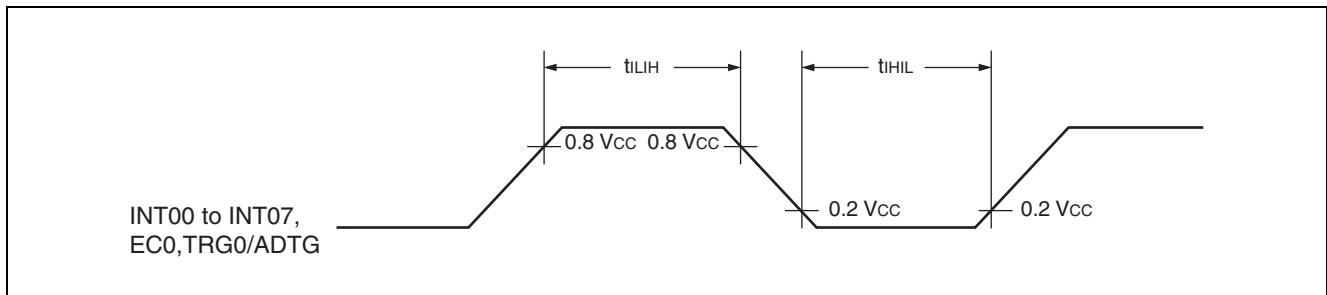

# MB95130MB Series

## (6) UART/SIO Serial I/O Timing

( $V_{CC} = 5.0\text{ V} \pm 10\%$ ,  $AV_{SS} = V_{SS} = 0.0\text{ V}$ ,  $T_A = -40\text{ }^\circ\text{C}$  to  $+85\text{ }^\circ\text{C}$ )

Parameter	Symbol	Pin name	Condition	Value		Unit
				Min	Max	
Serial clock cycle time	$t_{SCYC}$	UCK0	Internal clock operation output pin : $C_L = 80\text{ pF} + 1\text{ TTL}$ .	$4\ t_{MCLK}^*$	—	ns
UCK ↓ → UO time	$t_{SLOV}$	UCK0, UO0		- 190	+190	ns
Valid UI → UCK ↑	$t_{IVSH}$	UCK0, UI0		$2\ t_{MCLK}^*$	—	ns
UCK ↑ → valid UI hold time	$t_{SHIX}$	UCK0, UI0		$2\ t_{MCLK}^*$	—	ns
Serial clock "H" pulse width	$t_{SHSL}$	UCK0	External clock operation output pin : $C_L = 80\text{ pF} + 1\text{ TTL}$ .	$4\ t_{MCLK}^*$	—	ns
Serial clock "L" pulse width	$t_{SLSH}$	UCK0		$4\ t_{MCLK}^*$	—	ns
UCK ↓ → UO time	$t_{SLOV}$	UCK0, UO0		—	190	ns
Valid UI → UCK ↑	$t_{IVSH}$	UCK0, UI0		$2\ t_{MCLK}^*$	—	ns
UCK ↑ → valid UI hold time	$t_{SHIX}$	UCK0, UI0	$2\ t_{MCLK}^*$	—	ns	

\* : Refer to "(2) Source Clock/Machine Clock" for  $t_{MCLK}$ .

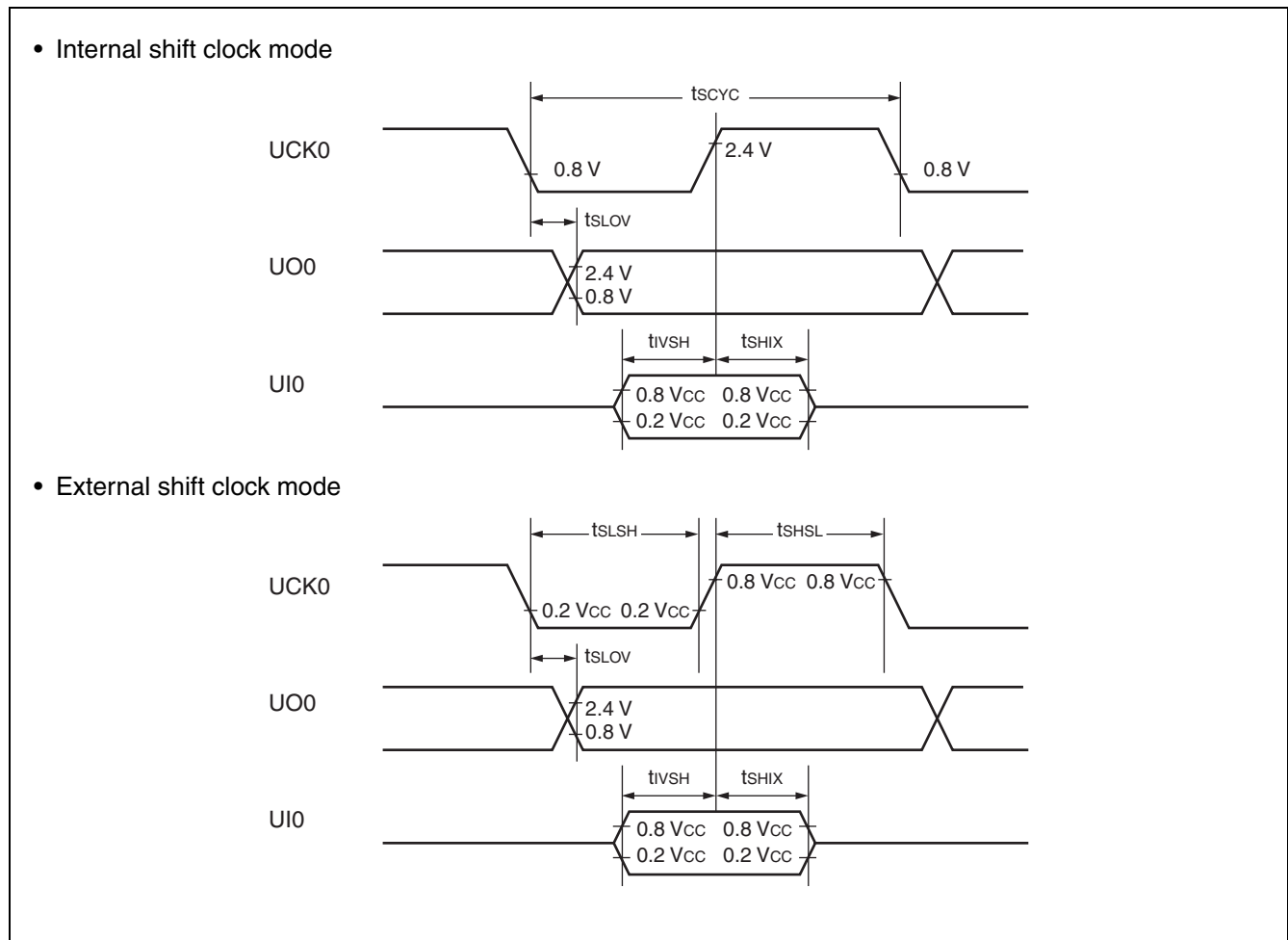

## (7) LIN-UART Timing

Sampling at the rising edge of sampling clock\*1 and prohibited serial clock delay\*2

(ESCR register : SCES bit = 0, ECCR register : SCDE bit = 0)

( $V_{CC} = 5.0\text{ V} \pm 10\%$ ,  $AV_{SS} = V_{SS} = 0.0\text{ V}$ ,  $T_A = -40\text{ }^\circ\text{C}$  to  $+85\text{ }^\circ\text{C}$ )

Parameter	Symbol	Pin name	Condition	Value		Unit
				Min	Max	
Serial clock cycle time	$t_{SCYC}$	SCK	Internal clock operation output pin : $C_L = 80\text{ pF} + 1\text{ TTL}$ .	$5 t_{MCLK}^{*3}$	—	ns
SCK $\downarrow \rightarrow$ SOT delay time	$t_{SLOVI}$	SCK, SOT		-95	+95	ns
Valid SIN $\rightarrow$ SCK $\uparrow$	$t_{IVSHI}$	SCK, SIN		$t_{MCLK}^{*3} + 190$	—	ns
SCK $\uparrow \rightarrow$ valid SIN hold time	$t_{SHIXI}$	SCK, SIN		0	—	ns
Serial clock "L" pulse width	$t_{SLSH}$	SCK	External clock operation output pin : $C_L = 80\text{ pF} + 1\text{ TTL}$ .	$3 t_{MCLK}^{*3} - t_R$	—	ns
Serial clock "H" pulse width	$t_{SHSL}$	SCK		$t_{MCLK}^{*3} + 95$	—	ns
SCK $\downarrow \rightarrow$ SOT delay time	$t_{SLOVE}$	SCK, SOT		—	$2 t_{MCLK}^{*3} + 95$	ns
Valid SIN $\rightarrow$ SCK $\uparrow$	$t_{IVSHE}$	SCK, SIN		190	—	ns
SCK $\uparrow \rightarrow$ valid SIN hold time	$t_{SHIXE}$	SCK, SIN		$t_{MCLK}^{*3} + 95$	—	ns
SCK fall time	$t_F$	SCK		—	10	ns
SCK rise time	$t_R$	SCK		—	10	ns

\*1 : Provide switch function whether sampling of reception data is performed at rising edge or falling edge of the serial clock.

\*2 : Serial clock delay function is used to delay half clock for the output signal of serial clock.

\*3 : Refer to "(2) Source Clock/Machine Clock" for  $t_{MCLK}$ .

# MB95130MB Series

- Internal shift clock mode

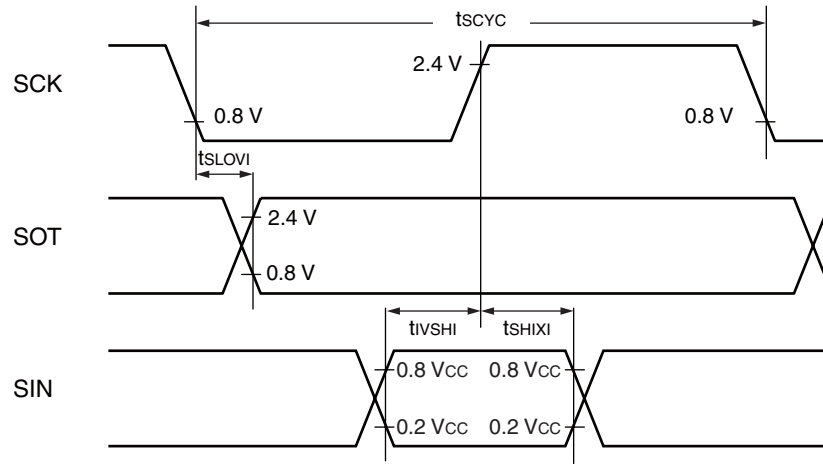

- External shift clock mode

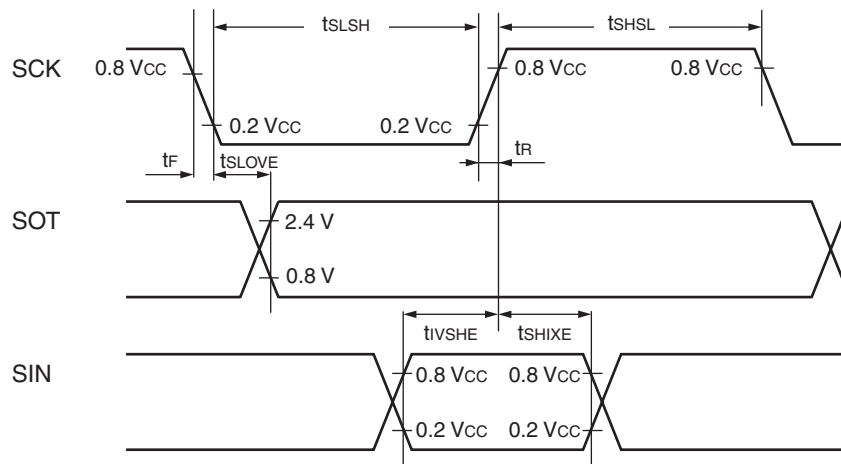

# MB95130MB Series

Sampling at the falling edge of sampling clock\*1 and prohibited serial clock delay\*2  
(ESCR register : SCES bit = 1, ECCR register : SCDE bit = 0)

( $V_{CC} = 5.0 V \pm 10\%$ ,  $AV_{SS} = V_{SS} = 0.0 V$ ,  $T_A = -40\text{ }^\circ\text{C}$  to  $+85\text{ }^\circ\text{C}$ )

Parameter	Symbol	Pin name	Condition	Value		Unit
				Min	Max	
Serial clock cycle time	$t_{SCYC}$	SCK	Internal clock operation output pin : $C_L = 80\text{ pF} + 1\text{ TTL}$ .	$5 t_{MCLK}^{*3}$	—	ns
SCK $\uparrow$ → SOT delay time	$t_{SHOVI}$	SCK, SOT		-95	+95	ns
Valid SIN → SCK $\downarrow$	$t_{IVSLI}$	SCK, SIN		$t_{MCLK}^{*3} + 190$	—	ns
SCK $\downarrow$ → valid SIN hold time	$t_{SLIXI}$	SCK, SIN		0	—	ns
Serial clock "H" pulse width	$t_{SHSL}$	SCK	External clock operation output pin : $C_L = 80\text{ pF} + 1\text{ TTL}$ .	$3 t_{MCLK}^{*3} - t_R$	—	ns
Serial clock "L" pulse width	$t_{SLSH}$	SCK		$t_{MCLK}^{*3} + 95$	—	ns
SCK $\uparrow$ → SOT delay time	$t_{SHOVE}$	SCK, SOT		—	$2 t_{MCLK}^{*3} + 95$	ns
Valid SIN → SCK $\downarrow$	$t_{IVSLE}$	SCK, SIN		190	—	ns
SCK $\downarrow$ → valid SIN hold time	$t_{SLIXE}$	SCK, SIN		$t_{MCLK}^{*3} + 95$	—	ns
SCK fall time	$t_F$	SCK		—	10	ns
SCK rise time	$t_R$	SCK		—	10	ns

\*1 : Provide switch function whether sampling of reception data is performed at rising edge or falling edge of the serial clock.

\*2 : Serial clock delay function is used to delay half clock for the output signal of serial clock.

\*3 : Refer to "(2) Source Clock/Machine Clock" for  $t_{MCLK}$ .

# MB95130MB Series

- Internal shift clock mode

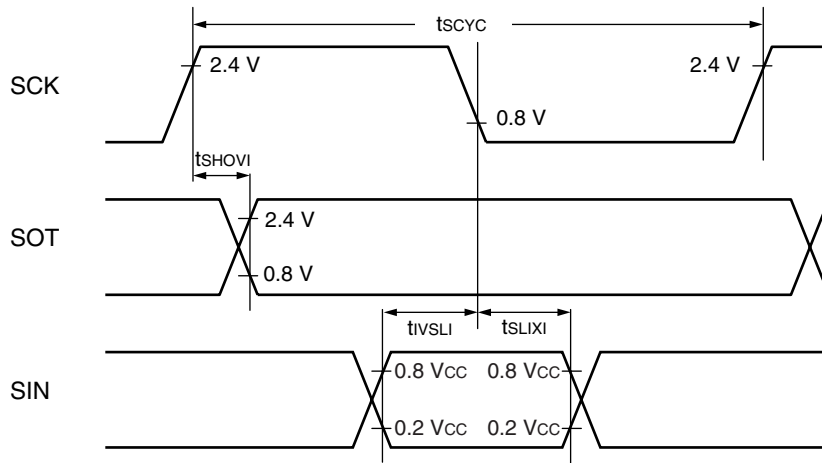

- External shift clock mode

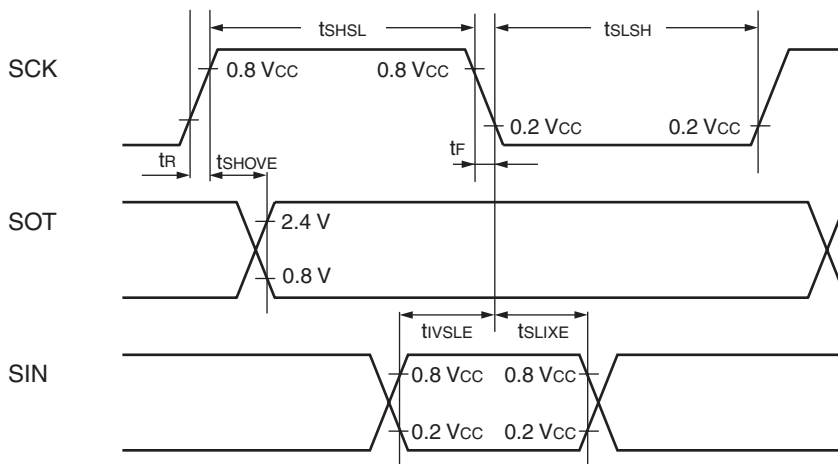



# MB95130MB Series

Sampling at the rising edge of sampling clock\*<sup>1</sup> and enabled serial clock delay\*<sup>2</sup>  
 (ESCR register : SCES bit = 0, ECCR register : SCDE bit = 1)

( $V_{CC} = 5.0 V \pm 10\%$ ,  $AV_{SS} = V_{SS} = 0.0 V$ ,  $T_A = -40\text{ }^\circ\text{C}$  to  $+85\text{ }^\circ\text{C}$ )

Parameter	Symbol	Pin name	Condition	Value		Unit
				Min	Max	
Serial clock cycle time	$t_{SCYC}$	SCK	Internal clock operation output pin : $C_L = 80\text{ pF} + 1\text{ TTL.}$	$5 t_{MCLK}^{*3}$	—	ns
SCK $\uparrow$ → SOT delay time	$t_{SHOVI}$	SCK, SOT		-95	+95	ns
Valid SIN → SCK $\downarrow$	$t_{IVSLI}$	SCK, SIN		$t_{MCLK}^{*3} + 190$	—	ns
SCK $\downarrow$ → valid SIN hold time	$t_{SLIXI}$	SCK, SIN		0	—	ns
SOT → SCK $\downarrow$ delay time	$t_{SOVLI}$	SCK, SOT		—	$4 t_{MCLK}^{*3}$	ns

\*1 : Provide switch function whether sampling of reception data is performed at rising edge or falling edge of the serial clock.

\*2 : Serial clock delay function is used to delay half clock for the output signal of serial clock.

\*3 : Refer to “ (2) Source Clock/Machine Clock” for  $t_{MCLK}$ .

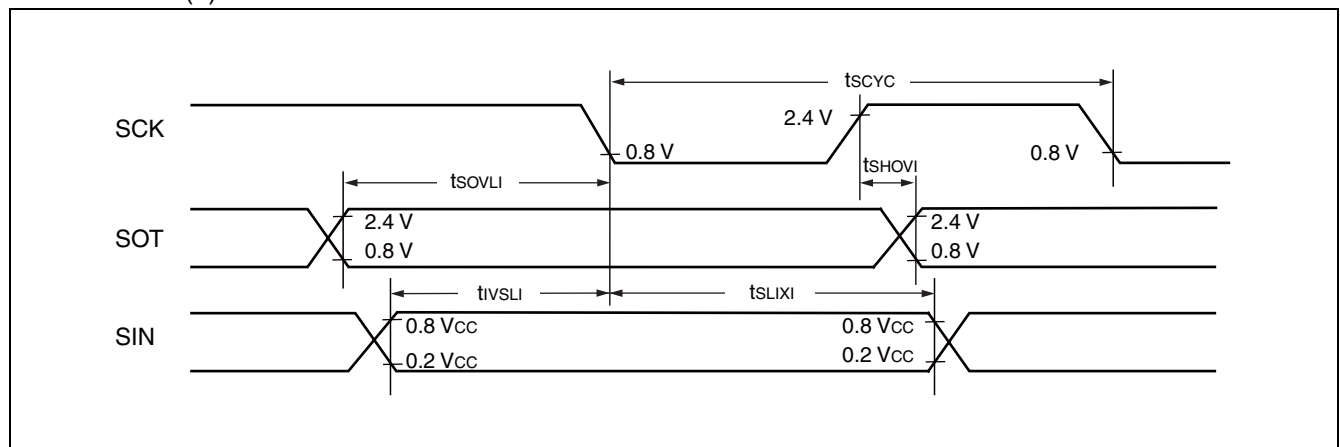

# MB95130MB Series

Sampling at the falling edge of sampling clock\*1 and enabled serial clock delay\*2  
 (ESCR register : SCES bit = 1, ECCR register : SCDE bit = 1)

( $V_{CC} = 5.0\text{ V} \pm 10\%$ ,  $AV_{SS} = V_{SS} = 0.0\text{ V}$ ,  $T_A = -40\text{ }^\circ\text{C}$  to  $+85\text{ }^\circ\text{C}$ )

Parameter	Symbol	Pin name	Condition	Value		Unit
				Min	Max	
Serial clock cycle time	$t_{SCYC}$	SCK	Internal clock operating output pin : $C_L = 80\text{ pF} + 1\text{ TTL}$ .	$5 t_{MCLK}^{*3}$	—	ns
SCK $\downarrow \rightarrow$ SOT delay time	$t_{SLOVI}$	SCK, SOT		-95	+95	ns
Valid SIN $\rightarrow$ SCK $\uparrow$	$t_{VSHI}$	SCK, SIN		$t_{MCLK}^{*3} + 190$	—	ns
SCK $\uparrow \rightarrow$ valid SIN hold time	$t_{SHIXI}$	SCK, SIN		0	—	ns
SOT $\rightarrow$ SCK $\uparrow$ delay time	$t_{SOVHI}$	SCK, SOT		—	$4 t_{MCLK}^{*3}$	ns

\*1 : Provide switch function whether sampling of reception data is performed at rising edge or falling edge of the serial clock.

\*2 : Serial clock delay function is used to delay half clock for the output signal of serial clock.

\*3 : Refer to “ (2) Source Clock/Machine Clock” for  $t_{MCLK}$ .

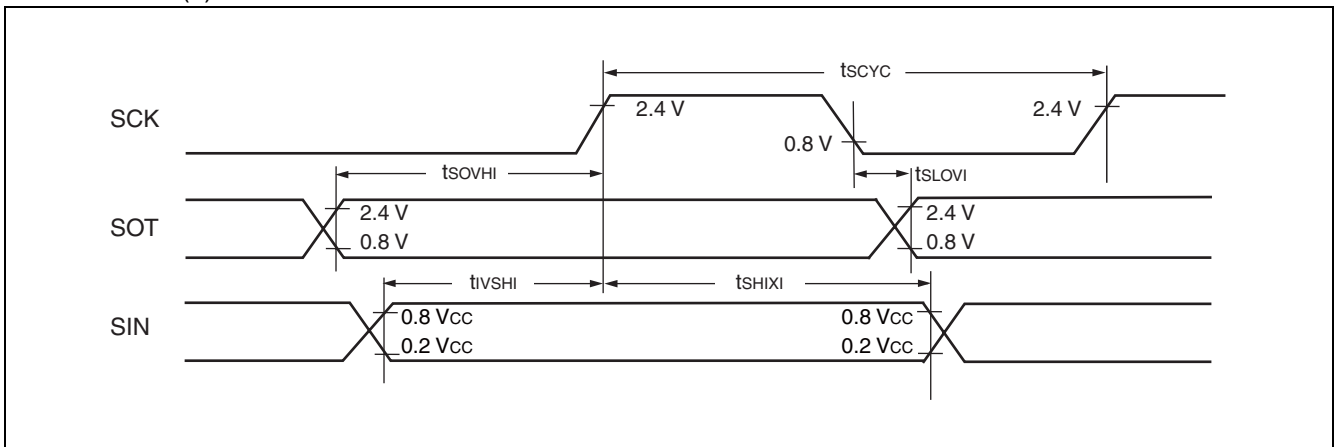

## (8) Low voltage Detection

( $A_{V_{SS}} = V_{SS} = 0.0 \text{ V}$ ,  $T_A = -40 \text{ }^\circ\text{C}$  to  $+85 \text{ }^\circ\text{C}$ )

Parameter	Symbol	Value			Unit	Remarks
		Min	Typ	Max		
Release voltage	$V_{DL+}$	2.52	2.70	2.88	V	At power-supply rise
Detection voltage	$V_{DL-}$	2.42	2.60	2.78	V	At power-supply fall
Hysteresis width	$V_{HYS}$	70	100	—	mV	
Power-supply start voltage	$V_{off}$	—	—	2.3	V	
Power-supply end voltage	$V_{on}$	4.9	—	—	V	
Power-supply voltage change time (at power supply rise)	$t_r$	0.3	—	—	$\mu\text{s}$	Slope of power supply that reset release signal generates
		—	3000	—	$\mu\text{s}$	Slope of power supply that reset release signal generates within rating ( $V_{DL+}$ )
Power-supply voltage change time (at power supply fall)	$t_f$	300	—	—	$\mu\text{s}$	Slope of power supply that reset detection signal generates
		—	300	—	$\mu\text{s}$	Slope of power supply that reset detection signal generates within rating ( $V_{DL-}$ )
Reset release delay time	$t_{d1}$	—	—	400	$\mu\text{s}$	
Reset detection delay time	$t_{d2}$	—	—	30	$\mu\text{s}$	
Consumption current	$I_{LVD}$	—	38	50	$\mu\text{A}$	Consumption current of low voltage detection circuit only

# MB95130MB Series

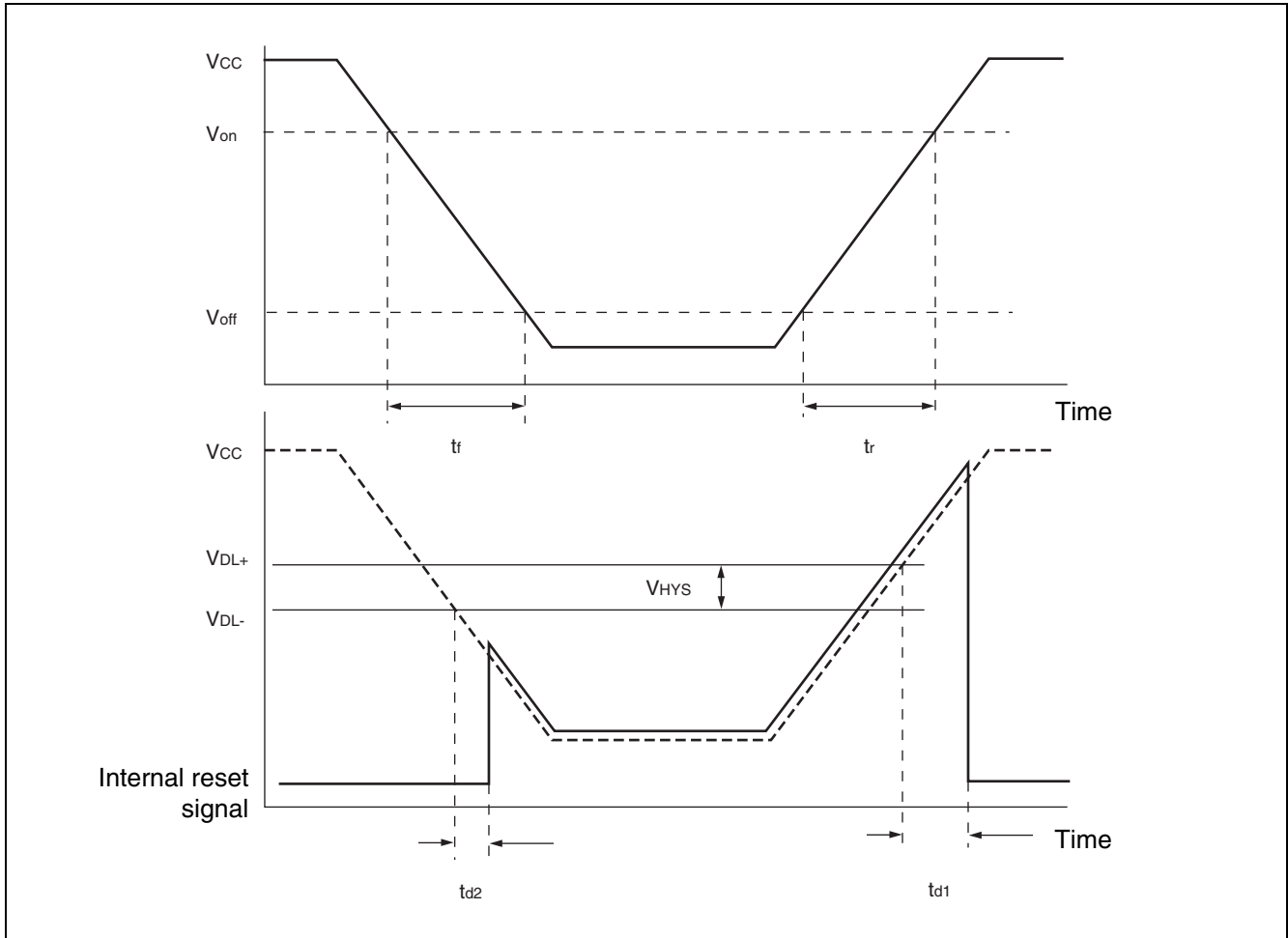

## (9) Clock Supervisor Clock

( $V_{CC} = AV_{CC} = 5\text{ V} \pm 10\%$ ,  $AV_{SS} = V_{SS} = 0.0\text{ V}$ ,  $T_A = -40\text{ }^\circ\text{C}$  to  $+85\text{ }^\circ\text{C}$ )

Parameter	Symbol	Value			Unit	Remarks
		Min	Typ	Max		
Oscillation frequency	$f_{OUT}$	50	100	200	kHz	
Oscillation start time	$t_{wk}$	—	—	10	$\mu\text{s}$	
Current consumption	$I_{CSV}$	—	20	36	$\mu\text{A}$	Current consumption of built-in CR oscillator at 100 kHz oscillation

# MB95130MB Series

## 5. A/D Converter

### (1) A/D Converter Electrical Characteristics

( $AV_{CC} = V_{CC} = 4.0\text{ V to }5.5\text{ V}$ ,  $AV_{SS} = V_{SS} = 0.0\text{ V}$ ,  $T_A = -40\text{ }^\circ\text{C to }+85\text{ }^\circ\text{C}$ )

Parameter	Symbol	Value			Unit	Remarks
		Min	Typ	Max		
Resolution	—	—	—	10	bit	
Total error		-3.0	—	+3.0	LSB	
Linearity error		-2.5	—	+2.5	LSB	
Differential linear error		-1.9	—	+1.9	LSB	
Zero transition voltage	$V_{OT}$	$AV_{SS} - 1.5\text{ LSB}$	$AV_{SS} + 0.5\text{ LSB}$	$AV_{SS} + 2.5\text{ LSB}$	V	
Full-scale transition voltage	$V_{FST}$	$AV_{CC} - 4.5\text{ LSB}$	$AV_{CC} - 1.5\text{ LSB}$	$AV_{CC} + 0.5\text{ LSB}$	V	
Compare time	—	0.9	—	16500	$\mu\text{s}$	$4.5\text{ V} \leq AV_{CC} \leq 5.5\text{ V}$
		1.8	—	16500	$\mu\text{s}$	$4.0\text{ V} \leq AV_{CC} < 4.5\text{ V}$
Sampling time	—	0.6	—	$\infty$	$\mu\text{s}$	$4.5\text{ V} \leq AV_{CC} \leq 5.5\text{ V}$ , At external impedance < at 5.4 k $\Omega$
		1.2	—	$\infty$	$\mu\text{s}$	$4.0\text{ V} \leq AV_{CC} \leq 4.5\text{ V}$ , At external impedance < at 2.4 k $\Omega$
Analog input current	$I_{AIN}$	-0.3	—	+0.3	$\mu\text{A}$	
Analog input voltage	$V_{AIN}$	$AV_{SS}$	—	$AV_{CC}$	V	

## (2) Notes on Using A/D Converter

### • External impedance of analog input and its sampling time

- A/D converter with sample and hold circuit. If the external impedance is too high to keep sufficient sampling time, the analog voltage charged to the internal sample and hold capacitor is insufficient, adversely affecting A/D conversion precision. Therefore to satisfy the A/D conversion precision standard, consider the relationship between the external impedance and minimum sampling time and either adjust the register value and operating frequency or decrease the external impedance so that the sampling time is longer than the minimum value. Also, if the sampling time cannot be sufficient, connect a capacitor of about 0.1  $\mu\text{F}$  to the analog input pin.

### • Analog input equivalent circuit

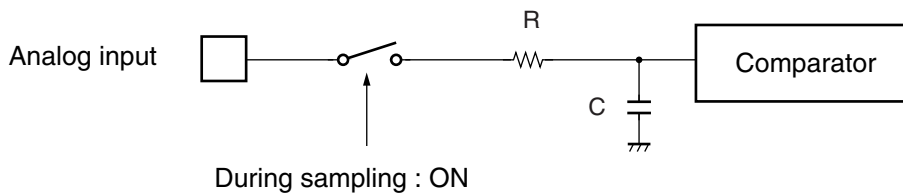

	<b>R</b>	<b>C</b>
$4.5\text{ V} \leq AV_{CC} \leq 5.5\text{ V}$	2.0 k $\Omega$ (Max)	16 pF (Max)
$4.0\text{ V} \leq AV_{CC} < 4.5\text{ V}$	8.2 k $\Omega$ (Max)	16 pF (Max)

Note : The values are reference values.

### • The relationship between external impedance and minimum sampling time

(External impedance = at 0 k $\Omega$  to 100 k $\Omega$ )

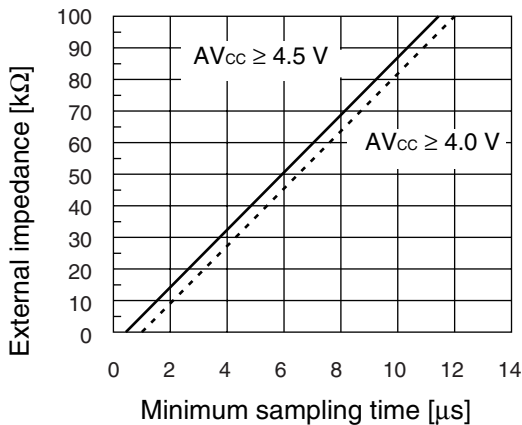

(External impedance = at 0 k $\Omega$  to 20 k $\Omega$ )

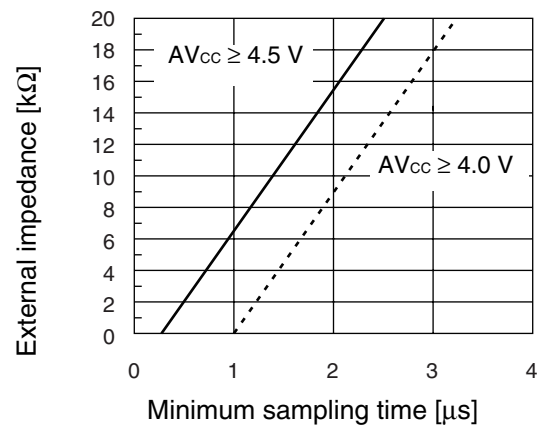

### • Errors

As  $AV_{CC} - AV_{SSL}$  becomes smaller, values of relative errors grow larger.

### (3) Definition of A/D Converter Terms

- Resolution  
The level of analog variation that can be distinguished by the A/D converter.  
When the number of bits is 10, analog voltage can be divided into  $2^{10} = 1024$ .
- Linearity error (unit : LSB)  
The deviation between the value along a straight line connecting the zero transition point (“00 0000 0000” ← → “00 0000 0001”) of a device and the full-scale transition point (“11 1111 1111” ← → “11 1111 1110”) compared with the actual conversion values obtained.
- Differential linear error (Unit : LSB)  
Deviation of input voltage, which is required for changing output code by 1 LSB, from an ideal value.
- Total error (unit: LSB)  
Difference between actual and theoretical values, caused by a zero transition error, full-scale transition error, linearity error, quantum error, and noise.

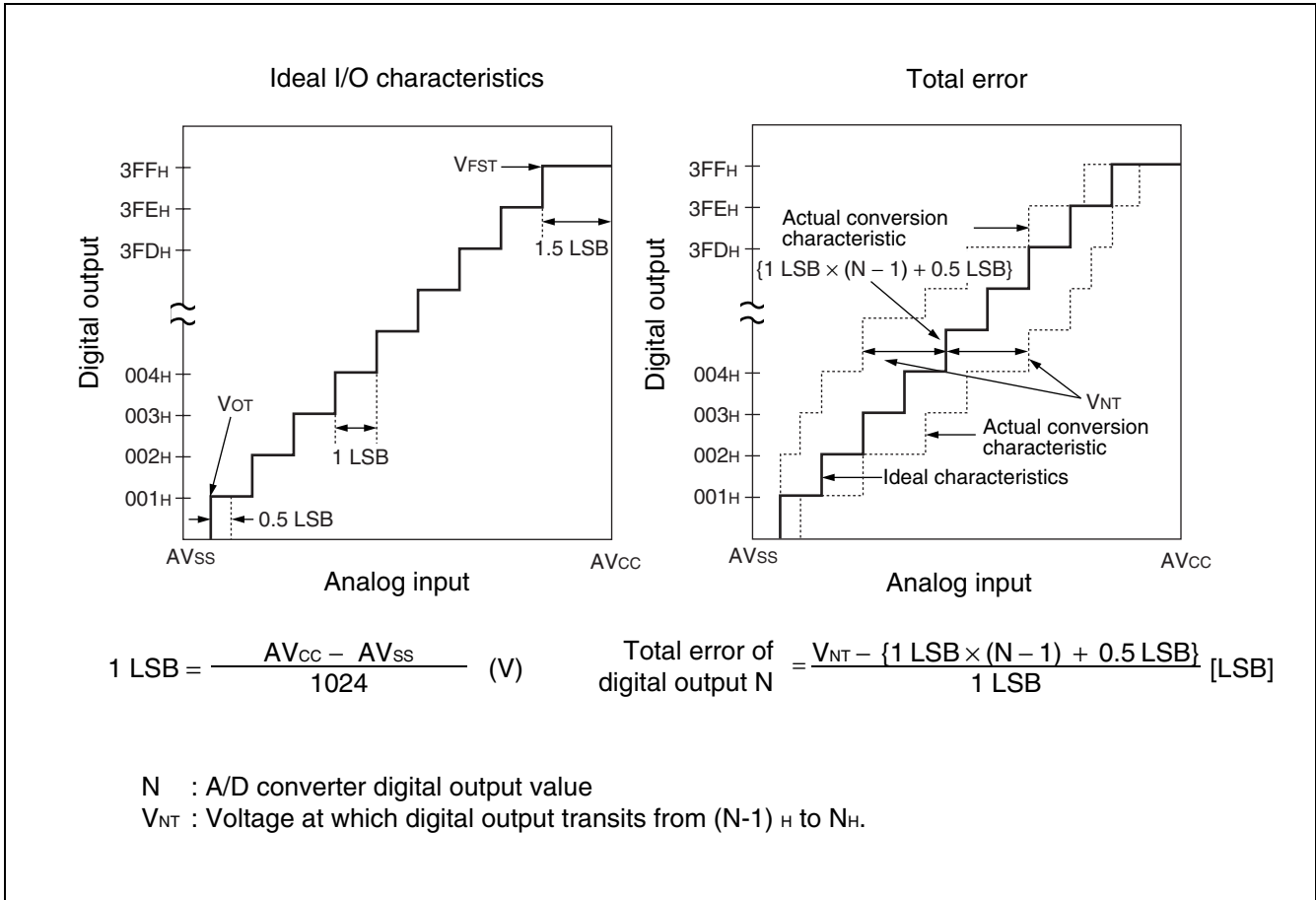

(Continued)



(Continued)

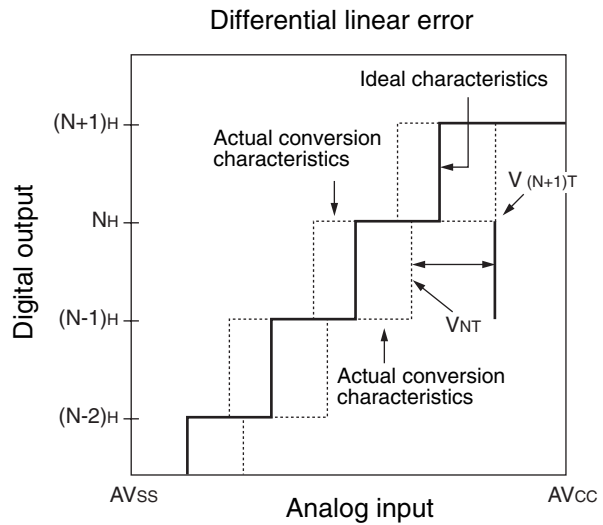
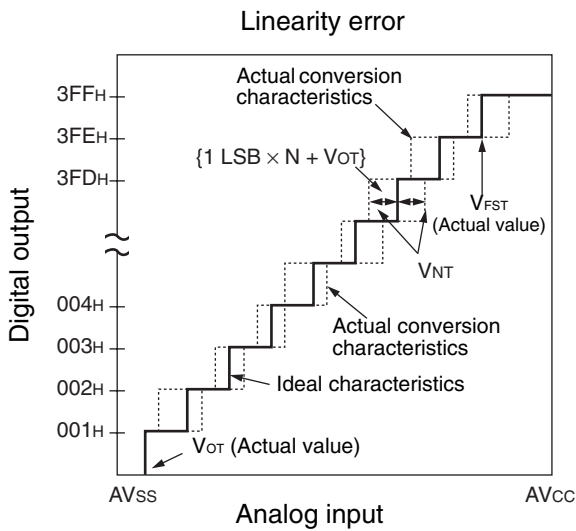
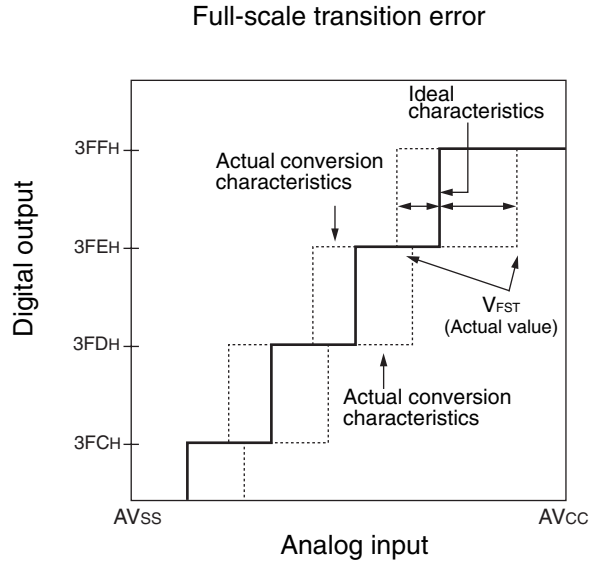
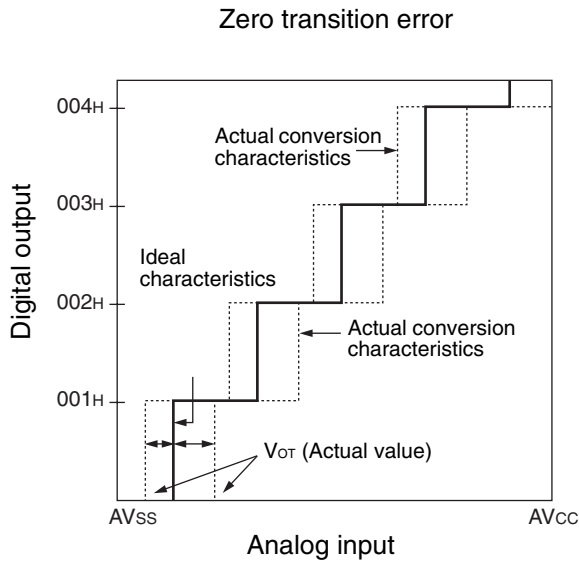

$$\text{Linear error of digital output } N = \frac{V_{NT} - \{1 \text{ LSB} \times N + V_{OT}\}}{1 \text{ LSB}}$$

$$\text{Differential linear error of digital output } N = \frac{V_{(N+1)T} - V_{NT}}{1 \text{ LSB}} - 1$$

N : A/D converter digital output value

$V_{NT}$  : Voltage at which digital output transits from  $(N - 1)_H$  to  $N_H$ .

$V_{OT}$  (Ideal value) =  $AV_{SS} + 0.5 \text{ LSB [V]}$

$V_{FST}$  (Ideal value) =  $AV_{CC} - 1.5 \text{ LSB [V]}$

# MB95130MB Series

## 6. Flash Memory Program/Erase Characteristics

Parameter	Value			Unit	Remarks
	Min	Typ	Max		
Chip erase time	—	1.0* <sup>1</sup>	15.0* <sup>2</sup>	s	Excludes 00 <sub>H</sub> programming prior erasure.
Byte programming time	—	32	3600	μs	Excludes system-level overhead.
Erase/program cycle	10000	—	—	cycle	
Power supply voltage at erase/ program	4.5	—	5.5	V	
Flash memory data retention time	20* <sup>3</sup>	—	—	year	Average T <sub>A</sub> = +85 °C

\*1 : T<sub>A</sub> = + 25 °C, V<sub>CC</sub> = 5.0 V, 10000 cycles

\*2 : T<sub>A</sub> = + 85 °C, V<sub>CC</sub> = 4.5 V, 10000 cycles

\*3 : This value comes from the technology qualification (using Arrhenius equation to translate high temperature measurements into normalized value at +85 °C) .

## ■ MASK OPTION

No.	Part number	MB95136MB	MB95F133MBS MB95F133NBS MB95F133JBS MB95F134MBS MB95F134NBS MB95F134JBS MB95F136MBS MB95F136NBS MB95F136JBS	MB95F133MBW MB95F133NBW MB95F133JBW MB95F134MBW MB95F134NBW MB95F134JBW MB95F136MBW MB95F136NBW MB95F136JBW	MB95FV100D-103
	Specifying procedure	Specify when ordering MASK	Setting disabled	Setting disabled	Setting disabled
1	Clock mode select • Single-system clock mode • Dual-system clock mode	selectable	Single-system clock mode	Dual-system clock mode	Changing by the switch on MCU board
2	Low voltage detection reset* • With low voltage detection reset • Without low voltage detection reset	Specify when ordering MASK	Specified by part number	Specified by part number	Change by the switch on MCU board
3	Clock supervisor* • With clock supervisor • Without clock supervisor	Specify when ordering MASK	Specified by part number	Specified by part number	Change by the switch on MCU board
4	Reset output* • With reset output • Without reset output	Specify when ordering MASK	Specified by part number	Specified by part number	MCU board switch set as following ; • With supervisor : Without reset output • Without supervisor : With reset output
5	Oscillation stabilization wait time	Fixed to oscillation stabilization wait time of $(2^{14} - 2) / F_{CH}$	Fixed to oscillation stabilization wait time of $(2^{14} - 2) / F_{CH}$	Fixed to oscillation stabilization wait time of $(2^{14} - 2) / F_{CH}$	Fixed to oscillation stabilization wait time of $(2^{14} - 2) / F_{CH}$

\*: Refer to table below about clock mode select, low voltage detection reset, clock supervisor select and reset output.

# MB95130MB Series

Part number	Clock mode select	Low-voltage detection reset	Clock supervisor	Reset output
MB95136MB	Single - system	No	No	Yes
		Yes	No	Yes
		Yes	Yes	No
	Dual - system	No	No	Yes
		Yes	No	Yes
		Yes	Yes	No
MB95F133MBS	Single - system	No	No	Yes
MB95F133NBS		Yes	No	Yes
MB95F133JBS		Yes	Yes	No
MB95F134MBS		No	No	Yes
MB95F134NBS		Yes	No	Yes
MB95F134JBS		Yes	Yes	No
MB95F136MBS		No	No	Yes
MB95F136NBS		Yes	No	Yes
MB95F136JBS		Yes	Yes	No
MB95F133MBW		Dual - system	No	No
MB95F133NBW	Yes		No	Yes
MB95F133JBW	Yes		Yes	No
MB95F134MBW	No		No	Yes
MB95F134NBW	Yes		No	Yes
MB95F134JBW	Yes		Yes	No
MB95F136MBW	No		No	Yes
MB95F136NBW	Yes		No	Yes
MB95F136JBW	Yes		Yes	No
MB95FV100D-103	Single - system	No	No	Yes
		Yes	No	Yes
		Yes	Yes	No
	Dual - system	No	No	Yes
		Yes	No	Yes
		Yes	Yes	No

# MB95130MB Series

## ■ ORDERING INFORMATION

Part number	Package
MB95136MBPF MB95F133MBSPF MB95F133NBSPF MB95F133JBSPF MB95F134MBSPF MB95F134NBSPF MB95F134JBSPF MB95F136MBSPF MB95F136NBSPF MB95F136JBSPF MB95F133MBWPF MB95F133NBWPF MB95F133JBWPF MB95F134MBWPF MB95F134NBWPF MB95F134JBWPF MB95F136MBWPF MB95F136NBWPF MB95F136JBWPF	28-pin plastic SOP (FPT-28P-M17)
MB95136MBPFV MB95F133MBSPFV MB95F133NBSPFV MB95F133JBSPFV MB95F134MBSPFV MB95F134NBSPFV MB95F134JBSPFV MB95F136MBSPFV MB95F136NBSPFV MB95F136JBSPFV MB95F133MBWPFV MB95F133NBWPFV MB95F133JBWPFV MB95F134MBWPFV MB95F134NBWPFV MB95F134JBWPFV MB95F136MBWPFV MB95F136NBWPFV MB95F136JBWPFV	30-pin plastic SSOP (FPT-30P-M02)
MB2146-303A (MB95FV100D-103PBT)	MCU board ( 224-pin plastic PFBGA ) (BGA-224P-M08)

# MB95130MB Series

## PACKAGE DIMENSION

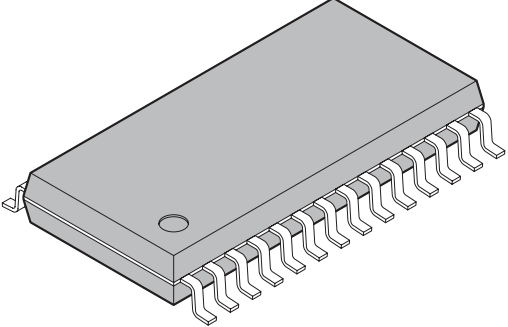
 <p>28-pin plastic SOP</p> <p>(FPT-28P-M17)</p>	Lead pitch	1.27 mm
	Package width × package length	8.6 × 17.75 mm
	Lead shape	Gullwing
	Sealing method	Plastic mold
	Mounting height	2.80 mm MAX
	Weight	0.82 g
	Code (Reference)	P-SOP28-8.6×17.75-1.27

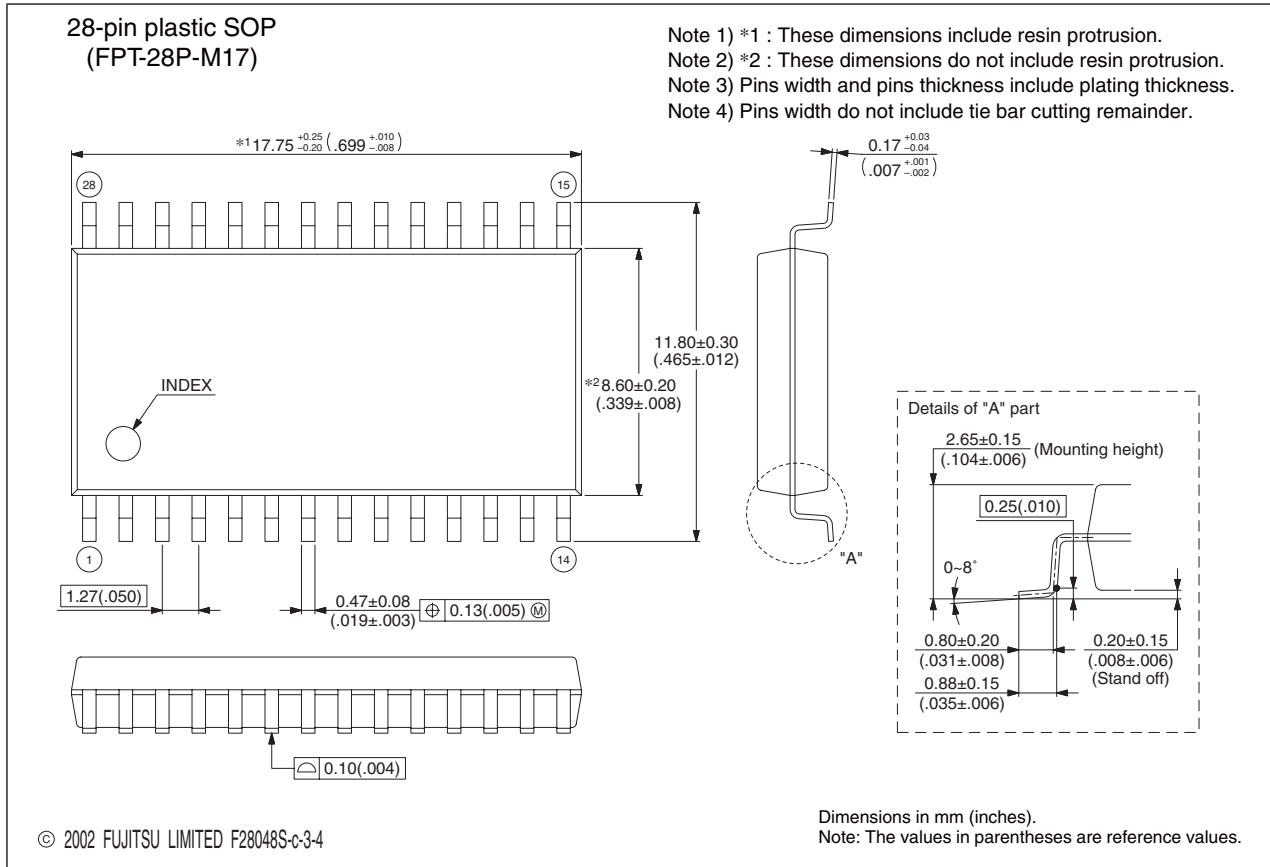

Please confirm the latest Package dimension by following URL.  
<http://edevic.fujitsu.com/fj/DATASHEET/ef-ovpklv.html>

(Continued)

# MB95130MB Series

(Continued)

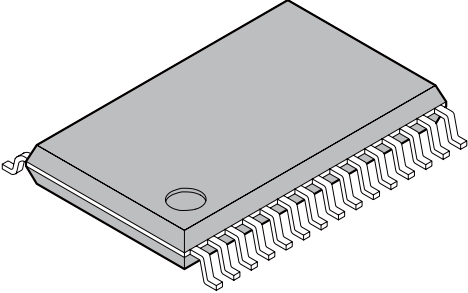
<p style="text-align: center;">30-pin plastic SSOP</p>  <p style="text-align: center;">(FPT-30P-M02)</p>	Lead pitch	0.65 mm
	Package width × package length	5.60 × 9.70 mm
	Lead shape	Gullwing
	Sealing method	Plastic mold
	Mounting height	1.45 mm MAX
	Code (Reference)	P-SSOP30-5.6×9.7-0.65

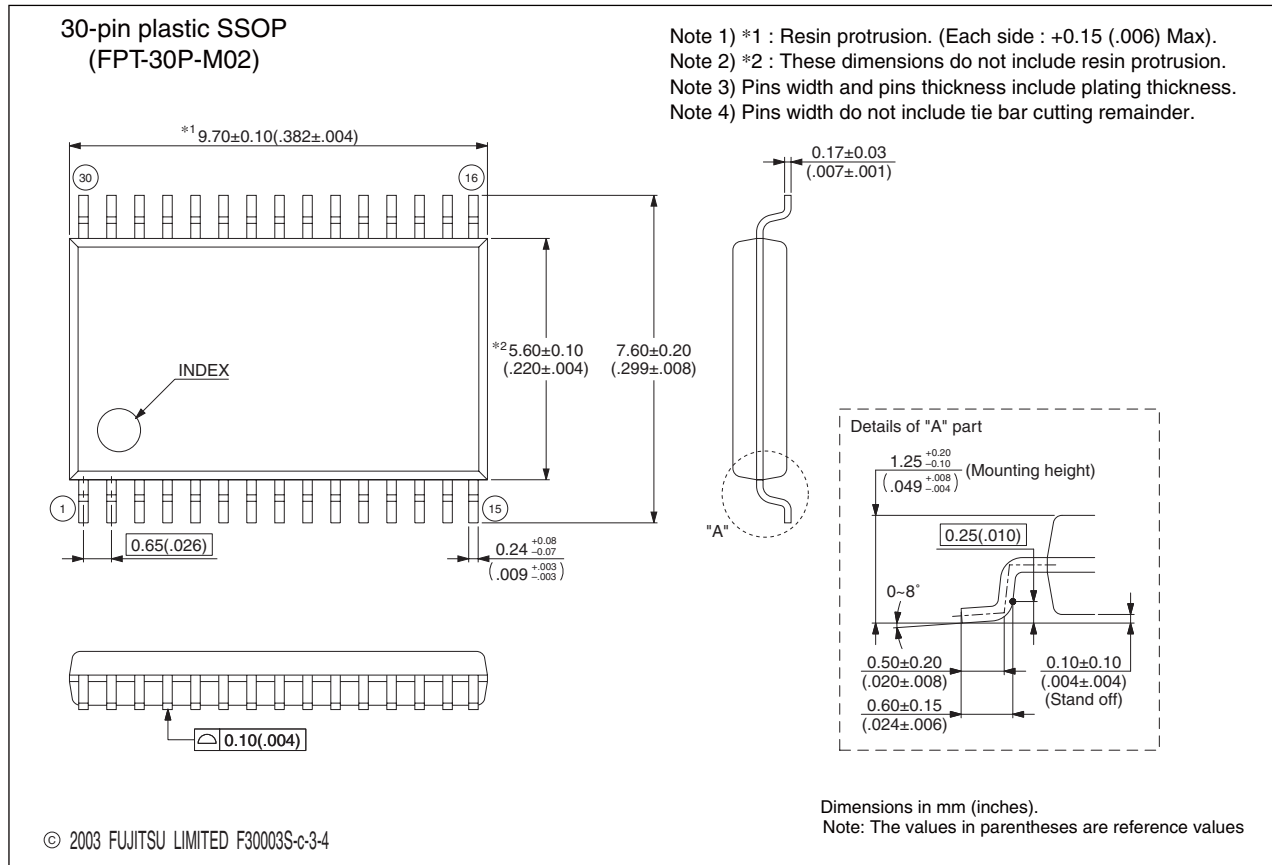

Please confirm the latest Package dimension by following URL.  
<http://edevic.fujitsu.com/fj/DATASHEET/ef-ovpkiv.html>

# MB95130MB Series

The information for microcontroller supports is shown in the following homepage.  
<http://www.fujitsu.com/global/services/microelectronics/product/micom/support/index.html>

## FUJITSU LIMITED

All Rights Reserved.

The contents of this document are subject to change without notice. Customers are advised to consult with FUJITSU sales representatives before ordering.

The information, such as descriptions of function and application circuit examples, in this document are presented solely for the purpose of reference to show examples of operations and uses of Fujitsu semiconductor device; Fujitsu does not warrant proper operation of the device with respect to use based on such information. When you develop equipment incorporating the device based on such information, you must assume any responsibility arising out of such use of the information. Fujitsu assumes no liability for any damages whatsoever arising out of the use of the information.

Any information in this document, including descriptions of function and schematic diagrams, shall not be construed as license of the use or exercise of any intellectual property right, such as patent right or copyright, or any other right of Fujitsu or any third party or does Fujitsu warrant non-infringement of any third-party's intellectual property right or other right by using such information. Fujitsu assumes no liability for any infringement of the intellectual property rights or other rights of third parties which would result from the use of information contained herein.

The products described in this document are designed, developed and manufactured as contemplated for general use, including without limitation, ordinary industrial use, general office use, personal use, and household use, but are not designed, developed and manufactured as contemplated (1) for use accompanying fatal risks or dangers that, unless extremely high safety is secured, could have a serious effect to the public, and could lead directly to death, personal injury, severe physical damage or other loss (i.e., nuclear reaction control in nuclear facility, aircraft flight control, air traffic control, mass transport control, medical life support system, missile launch control in weapon system), or (2) for use requiring extremely high reliability (i.e., submersible repeater and artificial satellite).

Please note that Fujitsu will not be liable against you and/or any third party for any claims or damages arising in connection with above-mentioned uses of the products.

Any semiconductor devices have an inherent chance of failure. You must protect against injury, damage or loss from such failures by incorporating safety design measures into your facility and equipment such as redundancy, fire protection, and prevention of over-current levels and other abnormal operating conditions.

If any products described in this document represent goods or technologies subject to certain restrictions on export under the Foreign Exchange and Foreign Trade Law of Japan, the prior authorization by Japanese government will be required for export of those products from Japan.

The company names and brand names herein are the trademarks or registered trademarks of their respective owners.

Edited Business Promotion Dept.