

**Boost chopper  
MOSFET Power Module**

**$V_{DSS} = 500V$   
 $R_{DSon} = 38m\Omega \text{ max @ } T_j = 25^\circ C$   
 $I_D = 90A \text{ @ } T_c = 25^\circ C$**

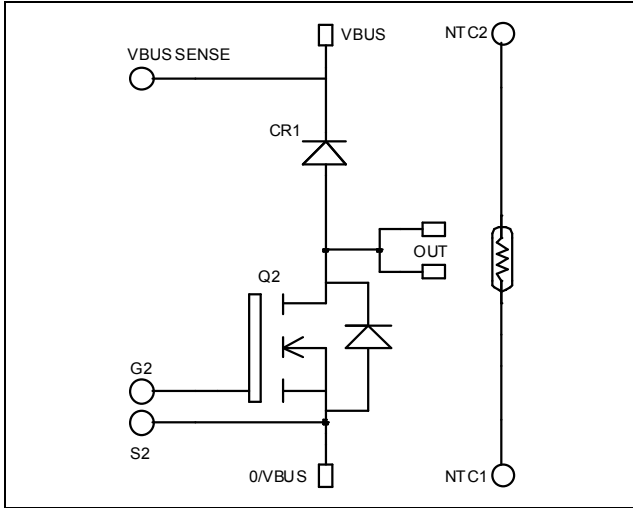

**Application**

- AC and DC motor control
- Switched Mode Power Supplies
- Power Factor Correction

**Features**

- Power MOS 7<sup>®</sup> MOSFETs
  - Low  $R_{DSon}$
  - Low input and Miller capacitance
  - Low gate charge
  - Avalanche energy rated
  - Very rugged
- Kelvin source for easy drive
- Very low stray inductance
  - Symmetrical design
  - Lead frames for power connections
- Internal thermistor for temperature monitoring
- High level of integration

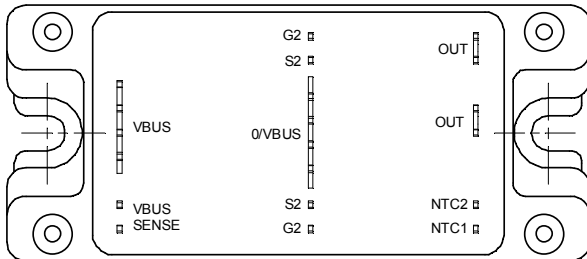

**Benefits**

- Outstanding performance at high frequency operation
- Direct mounting to heatsink (isolated package)
- Low junction to case thermal resistance
- Solderable terminals both for power and signal for easy PCB mounting
- Low profile

**Absolute maximum ratings**

Symbol	Parameter	Max ratings	Unit
$V_{DSS}$	Drain - Source Breakdown Voltage	500	V
$I_D$	Continuous Drain Current	$T_c = 25^\circ C$	90
		$T_c = 80^\circ C$	67
$I_{DM}$	Pulsed Drain current	360	
$V_{GS}$	Gate - Source Voltage	$\pm 30$	V
$R_{DSon}$	Drain - Source ON Resistance	38	m $\Omega$
$P_D$	Maximum Power Dissipation	$T_c = 25^\circ C$	694
$I_{AR}$	Avalanche current (repetitive and non repetitive)	46	A
$E_{AR}$	Repetitive Avalanche Energy	50	mJ
$E_{AS}$	Single Pulse Avalanche Energy	2500	

**CAUTION:** These Devices are sensitive to Electrostatic Discharge. Proper Handling Procedures Should Be Followed.

All ratings @  $T_j = 25^\circ\text{C}$  unless otherwise specified

## Electrical Characteristics

Symbol	Characteristic	Test Conditions	Min	Typ	Max	Unit
$BV_{DSS}$	Drain - Source Breakdown Voltage	$V_{GS} = 0V, I_D = 375\mu A$	500			V
$I_{DSS}$	Zero Gate Voltage Drain Current	$V_{GS} = 0V, V_{DS} = 500V$   $T_j = 25^\circ\text{C}$			150	$\mu A$
		$V_{GS} = 0V, V_{DS} = 400V$   $T_j = 125^\circ\text{C}$			750	
$R_{DS(on)}$	Drain - Source on Resistance	$V_{GS} = 10V, I_D = 45A$			38	$m\Omega$
$V_{GS(th)}$	Gate Threshold Voltage	$V_{GS} = V_{DS}, I_D = 5mA$	3		5	V
$I_{GSS}$	Gate - Source Leakage Current	$V_{GS} = \pm 30V, V_{DS} = 0V$			$\pm 150$	nA

## Dynamic Characteristics

Symbol	Characteristic	Test Conditions	Min	Typ	Max	Unit
$C_{iss}$	Input Capacitance	$V_{GS} = 0V$ $V_{DS} = 25V$ $f = 1MHz$		11.2		nF
$C_{oss}$	Output Capacitance			2.4		
$C_{rss}$	Reverse Transfer Capacitance			0.18		
$Q_g$	Total gate Charge	$V_{GS} = 10V$ $V_{Bus} = 250V$ $I_D = 90A$		246		nC
$Q_{gs}$	Gate - Source Charge			66		
$Q_{gd}$	Gate - Drain Charge			130		
$T_{d(on)}$	Turn-on Delay Time	<b>Inductive switching @ <math>125^\circ\text{C}</math></b> $V_{GS} = 15V$ $V_{Bus} = 333V$ $I_D = 90A$ $R_G = 2\Omega$		18		ns
$T_r$	Rise Time			35		
$T_{d(off)}$	Turn-off Delay Time			87		
$T_f$	Fall Time			77		
$E_{on}$	Turn-on Switching Energy ❶	<b>Inductive switching @ <math>25^\circ\text{C}</math></b> $V_{GS} = 15V, V_{Bus} = 333V$ $I_D = 90A, R_G = 2\Omega$		1510		$\mu J$
$E_{off}$	Turn-off Switching Energy ❷			1452		
$E_{on}$	Turn-on Switching Energy ❶	<b>Inductive switching @ <math>125^\circ\text{C}</math></b> $V_{GS} = 15V, V_{Bus} = 333V$ $I_D = 90A, R_G = 2\Omega$		2482		$\mu J$
$E_{off}$	Turn-off Switching Energy ❷			1692		

## Diode ratings and characteristics

Symbol	Characteristic	Test Conditions	Min	Typ	Max	Unit
$I_{F(AV)}$	Maximum Average Forward Current	50% duty cycle   $T_c = 70^\circ\text{C}$		60		A
$V_F$	Diode Forward Voltage	$I_F = 60A$		1.6	1.8	V
		$I_F = 120A$		1.9		
		$I_F = 60A$   $T_j = 125^\circ\text{C}$		1.4		
$t_{rr}$	Reverse Recovery Time	$I_F = 60A$   $T_j = 25^\circ\text{C}$		130		ns
		$V_R = 400V$   $T_j = 125^\circ\text{C}$ $di/dt = 200A/\mu s$		170		
$Q_{rr}$	Reverse Recovery Charge	$I_F = 60A$   $T_j = 25^\circ\text{C}$		220		nC
		$V_R = 400V$   $T_j = 125^\circ\text{C}$ $di/dt = 200A/\mu s$		920		

❶  $E_{on}$  includes diode reverse recovery.

❷ In accordance with JEDEC standard JESD24-1.

**Thermal and package characteristics**

Symbol	Characteristic	Min	Typ	Max	Unit	
R <sub>thJC</sub>	Junction to Case	Transistor		0.18	°C/W	
		Diode		0.9		
V <sub>ISOL</sub>	RMS Isolation Voltage, any terminal to case t = 1 min, I <sub>isol</sub> < 1mA, 50/60Hz	2500			V	
T <sub>J</sub>	Operating junction temperature range	-40		150	°C	
T <sub>STG</sub>	Storage Temperature Range	-40		125		
T <sub>C</sub>	Operating Case Temperature	-40		100		
Torque	Mounting torque		To Heatsink	M5	4.7	N.m
Wt	Package Weight				160	g

**Temperature sensor NTC**

Symbol	Characteristic	Min	Typ	Max	Unit
R <sub>25</sub>	Resistance @ 25°C		68		kΩ
B <sub>25/85</sub>	T <sub>25</sub> = 298.16 K		4080		K

$$R_T = \frac{R_{25}}{\exp \left[ B_{25/85} \left( \frac{1}{T_{25}} - \frac{1}{T} \right) \right]}$$

T: Thermistor temperature  
R<sub>T</sub>: Thermistor value at T

**Package outline**

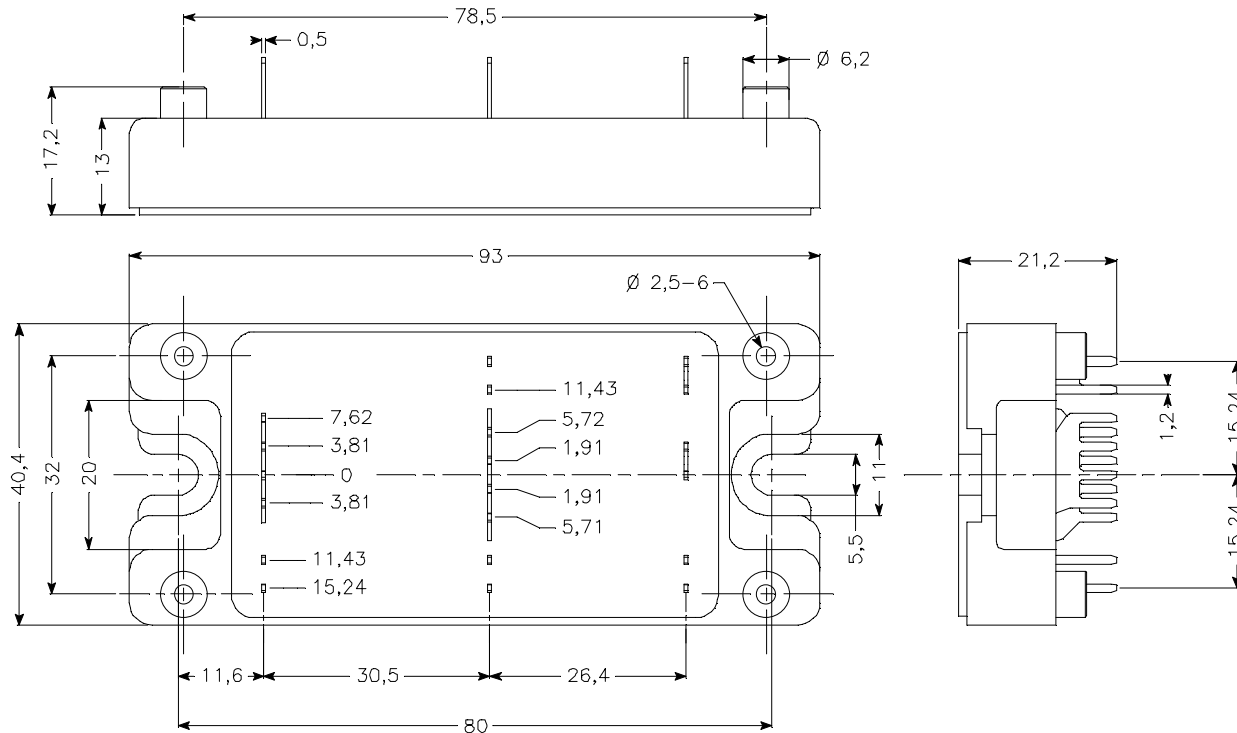

**Typical Performance Curve**

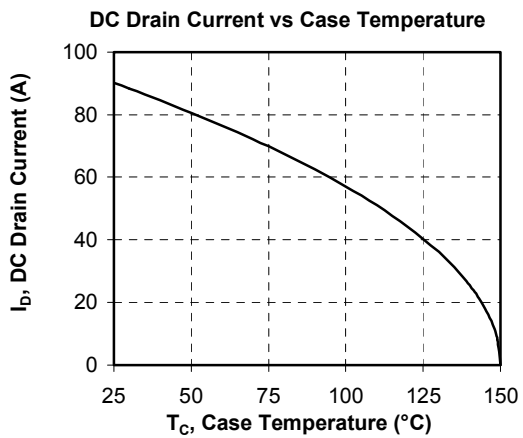
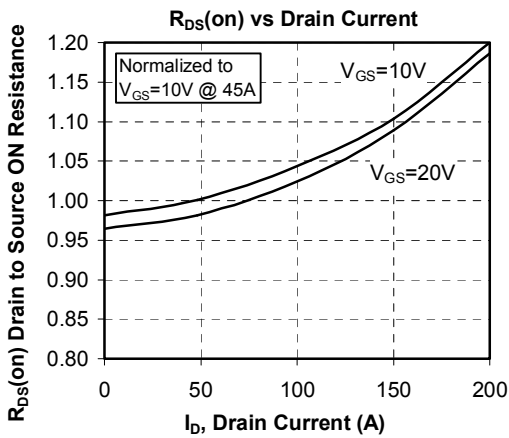
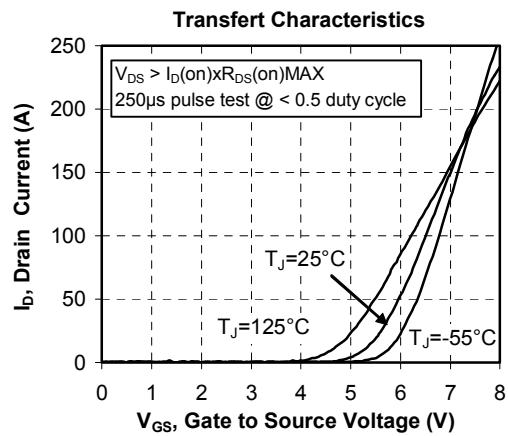
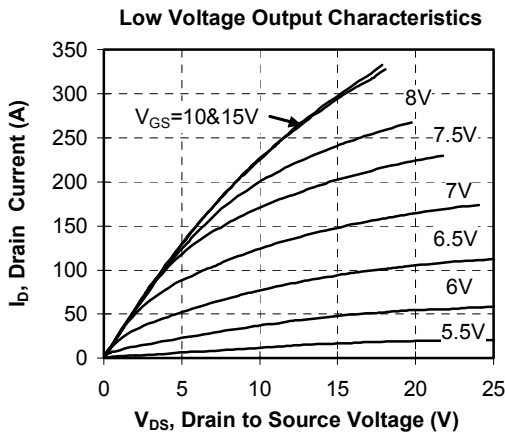
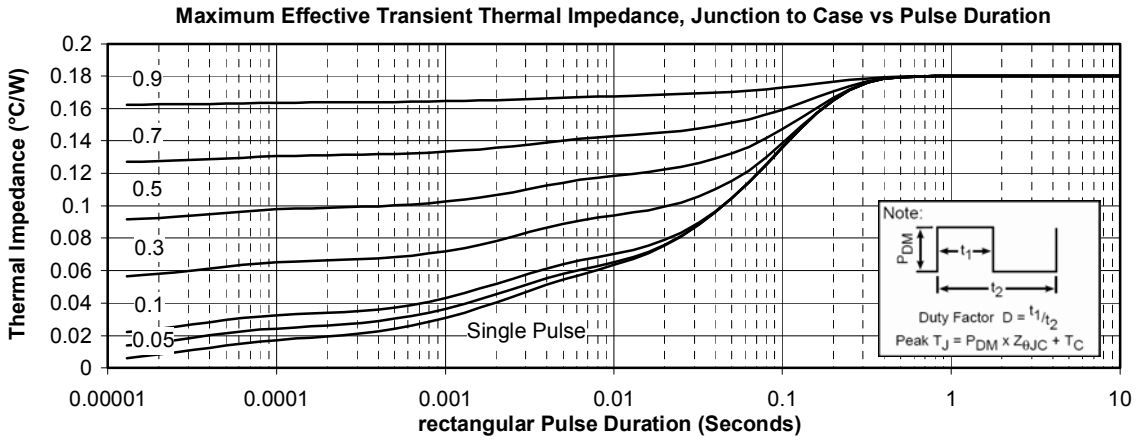

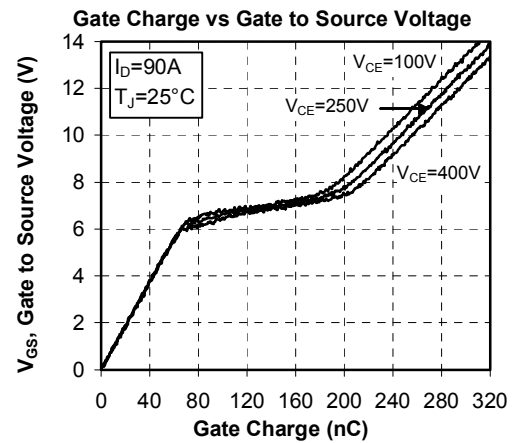
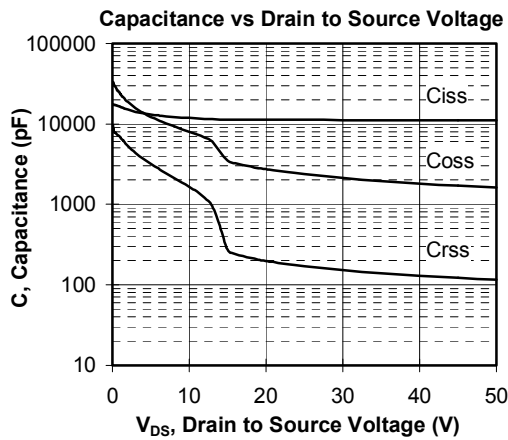
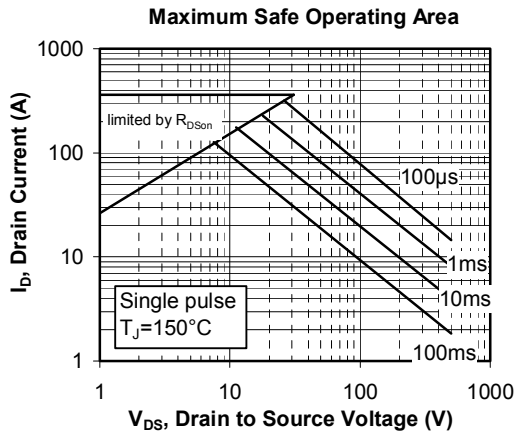
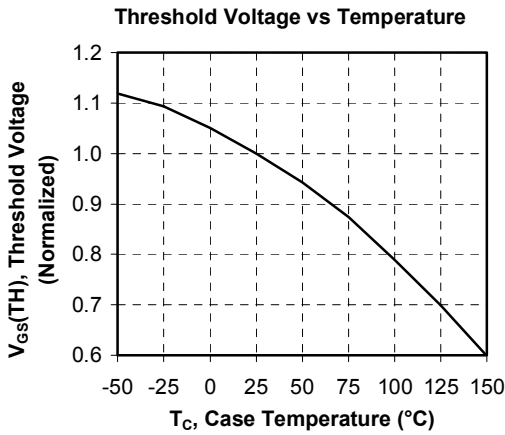
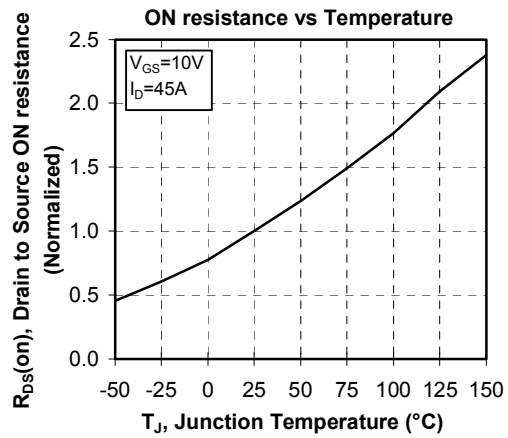
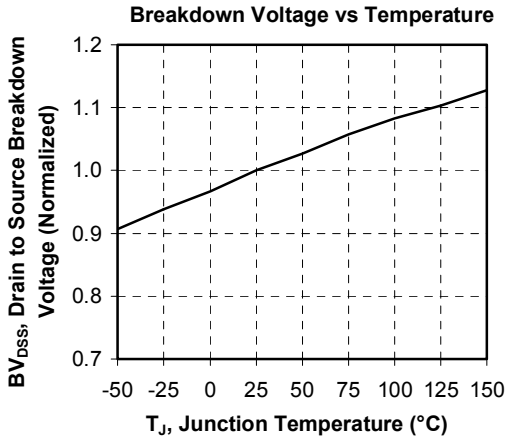

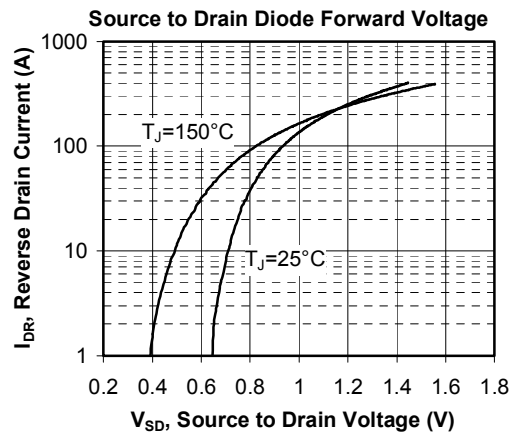
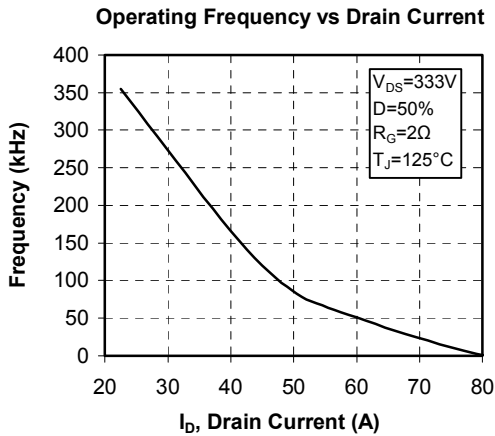
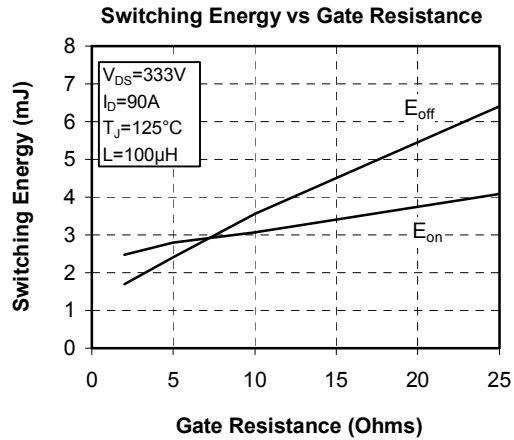
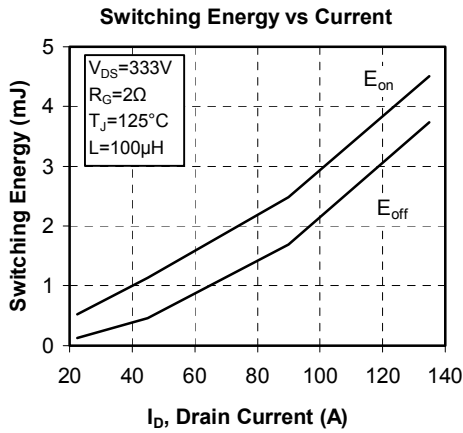
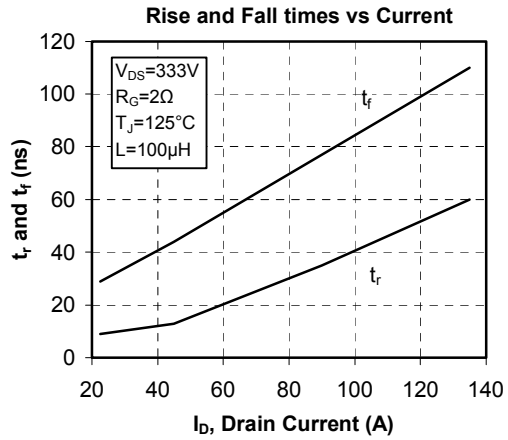
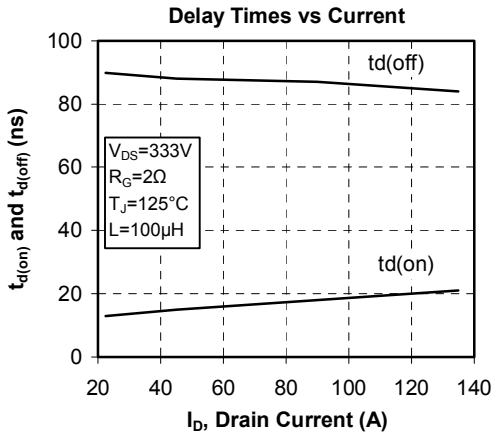

APT reserves the right to change, without notice, the specifications and information contained herein

APT's products are covered by one or more of U.S. patents 4,895,810 5,045,903 5,089,434 5,182,234 5,019,522 5,262,336 6,503,786 5,256,583 4,748,103 5,283,202 5,231,474 5,434,095 5,528,058 and foreign patents. U.S. and Foreign patents pending. All Rights Reserved.