

PC920 Power OPIC Photocoupler

T-41-83

Features

1. High power
(I_{O1} : MAX. -0.8A (DC))
(I_{O2} : MAX. 1.6A (Pulse))
2. Low input current drive
(I_{FLH} : MAX. 2mA at $T_a = T_{opr}$)
3. Operating supply voltage V_{CC} : 5.4~15V
4. Compact single-in-line package (With heat sink)
5. UL recognized, file No. E64380

Applications

1. Inverter controlled air conditioners

Outline Dimensions

(Unit : mm)

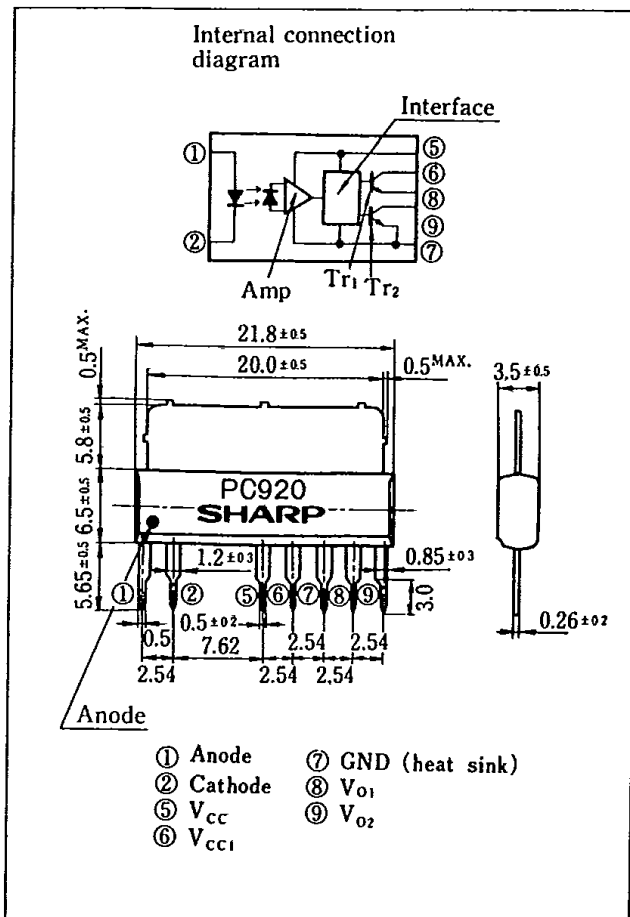

※ OPIC is a registered trademark of Sharp and stands for Optical IC. It has a light detecting element and signal processing circuitry integrated onto a single chip.

Absolute Maximum Ratings

($T_a = 25^\circ\text{C}$)

Parameter	Symbol	Rating	Unit
Input	Forward current	I_F	50 mA
	Reverse voltage	V_R	6 V
	Power dissipation	P	70 mW
Output	Supply voltage	V_{CC}	16 V
	V_{O1} output current	I_{O1}	-0.8 A
	*1 V_{O2} output current	I_{O2P}	1.6 A
	Total power dissipation	P_{tot}	1,200 mW
	*2 Isolation voltage	V_{iso}	1,500 Vrms
Operating temperature	T_{opr}	-20 ~ +80	$^\circ\text{C}$
Storage temperature	T_{stg}	-55 ~ +125	$^\circ\text{C}$
*3 Soldering temperature	T_{sol}	260	$^\circ\text{C}$

*1 Pulse width $\leq 10\mu\text{s}$, Duty ratio = 0.02

*2 RH = 40~60%, AC for 1 minute

*3 For 10 seconds

Electro-optical Characteristics

(Ta=25°C unless specified)

Parameter		Symbol	Conditions	MIN.	TYP.	MAX.	Unit			
Input	Forward voltage	V_F	$I_F=2mA$	—	1.1	1.4	V			
			$I_F=0.1mA$	0.6	0.95	—				
	Reverse current	I_R	$V_R=3V$	—	—	10	μA			
	Terminal capacitance	C_t	$V=0, f=1kHz$	—	30	80	pF			
	Operating supply voltage	V_{CC}		5.4	6.0	15	V			
Output	V_{O1} output voltage	V_{O1}	$V_{CC}=V_{CC1}=6V, I_{O1}=-0.3A, I_F=2mA$	4.5	5.2	—	V			
	V_{O2} output voltage	V_{O2}	$V_{CC}=V_{CC1}=6V, I_{O2P}=1A, I_F=0$	—	0.3	2.0	V			
	V_{O1} leak current	I_{OL1}	$V_{CC}=V_{CC1}=6V, V_{O1}=GND, I_F=0$	—	—	200	μA			
	V_{O2} leak current	I_{OL2}	$V_{CC}=V_{CC1}=6V, I_F=2mA$	—	—	200	μA			
	High level supply current	I_{CCH}	$V_{CC}=V_{CC1}=6V, I_F=2mA$	—	5	10	mA			
	Low level supply current	I_{CCL}	$V_{CC}=V_{CC1}=6V, I_F=0$	—	12	20	mA			
				$V_{CC}=V_{CC1}=6V, R_{L1}=15\Omega$	—	0.5	1.0	mA		
Transfer characteristics	**“Low→High” threshold input current	I_{FLH}	$T_a=T_{opr}, V_{CC}=V_{CC1}=6V, R_{L1}=15\Omega$	0.1	—	2.0	mA			
			DC=500V, RH=40~60%	5×10^{10}	10^{11}	—	Ω			
	Response time			$V_{CC}=V_{CC1}=6V$	“Low→High” propagation time	t_{PLH}	—	3	10	μs
					“High→Low” propagation time	t_{PHL}	—	3	10	
					Rise time	t_r	—	0.2	2	
					Fall time	t_f	—	0.2	2	

*4 I_{FLH} represents forward current when output goes from “low” to “high”.

Truth Table

Input	Output	Tr ₁	Tr ₂
ON	High level	ON	OFF
OFF	Low level	OFF	ON

Test Circuit for V_{O1}

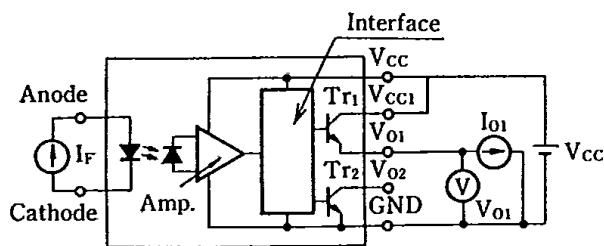

Test Circuit for V_{O2}

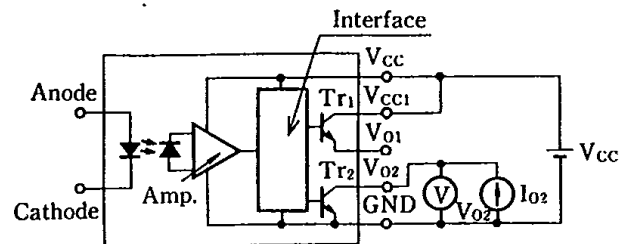

Test Circuit for I_{OL1}

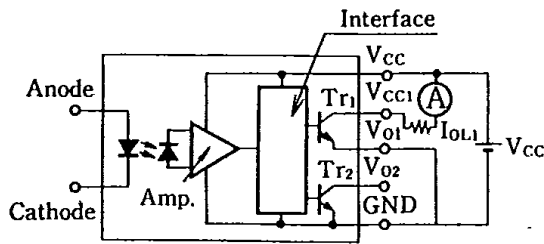

Test Circuit for I_{OL2}

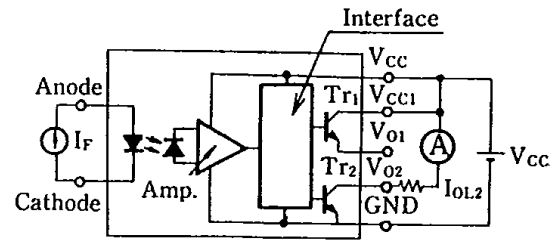

Test Circuit for Response Time

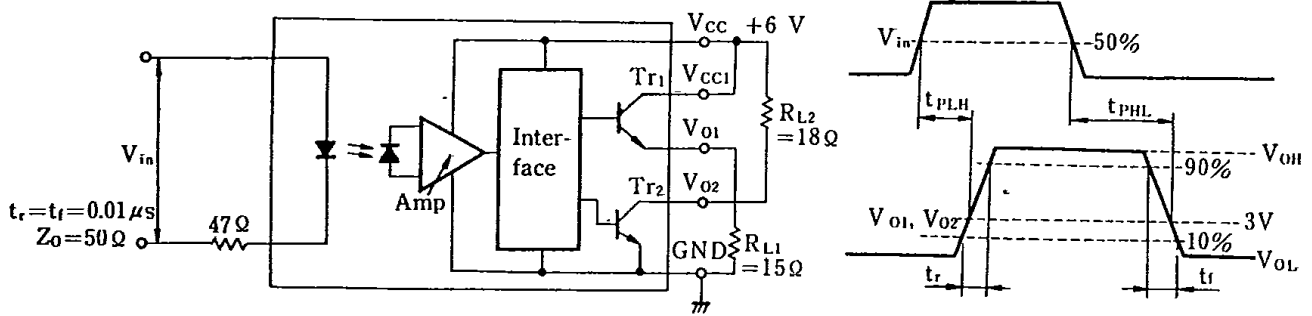

Fig. 1 Forward Current vs. Ambient Temperature

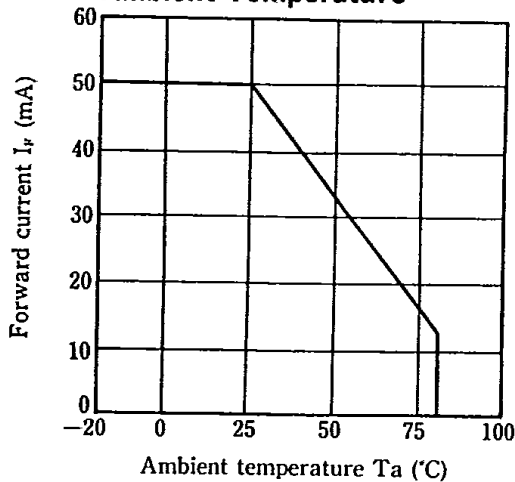
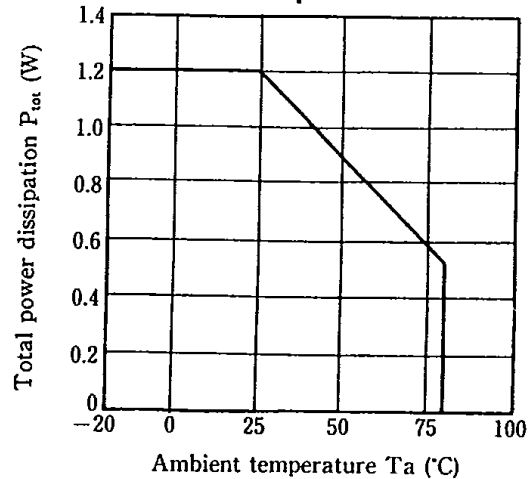

Fig. 2 Total Power Dissipation vs. Ambient Temperature



6

Fig. 3 Forward Current vs. Forward Voltage

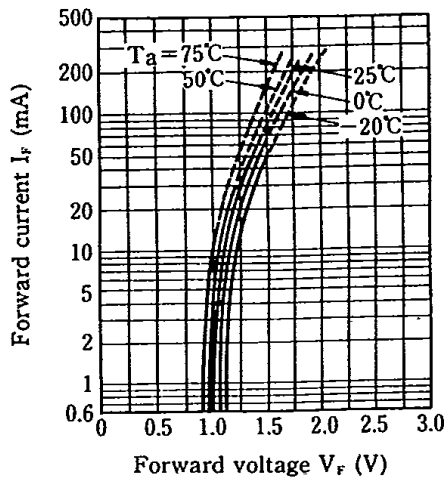

Fig. 4 Relative Threshold Input Current vs. Supply Voltage

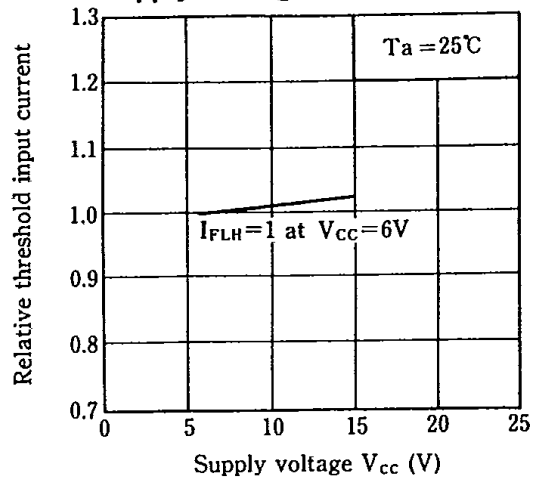

Fig. 5 Relative Threshold Input Current vs. Ambient Temperature

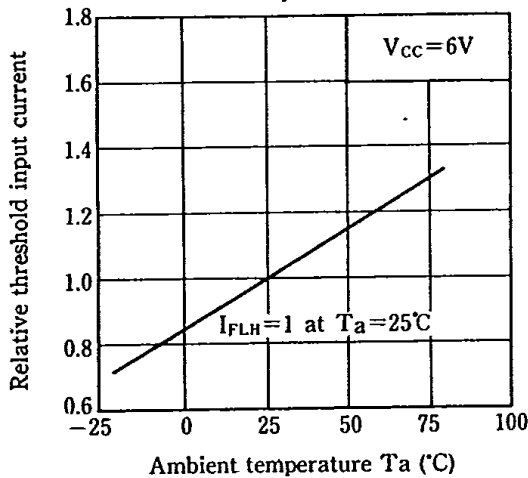

Fig. 6 Output Voltage vs. Output Current (Tr_1)

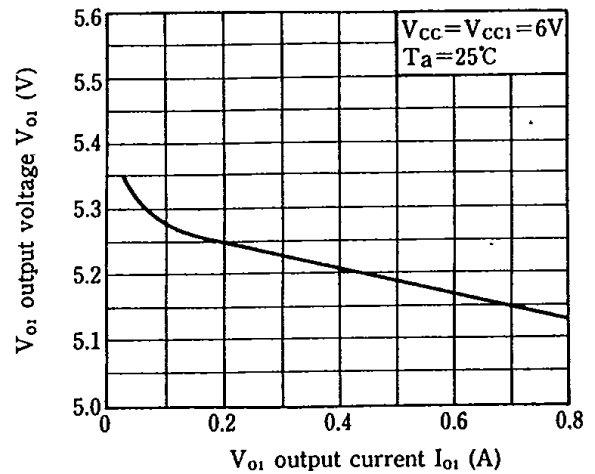

Fig. 7 Output Voltage vs. Output Current (Tr_2)

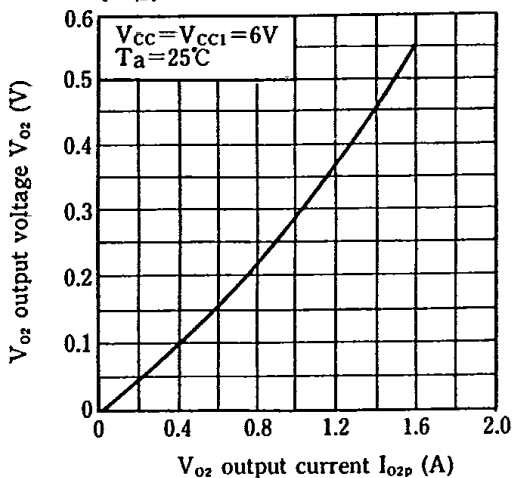

Fig. 8 Output Voltage vs. Ambient Temperature (Tr_1)

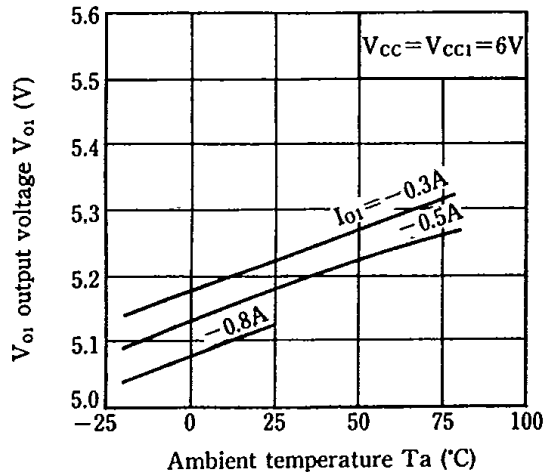

Fig. 9 Output Voltage vs. Ambient Temperature (T_r)

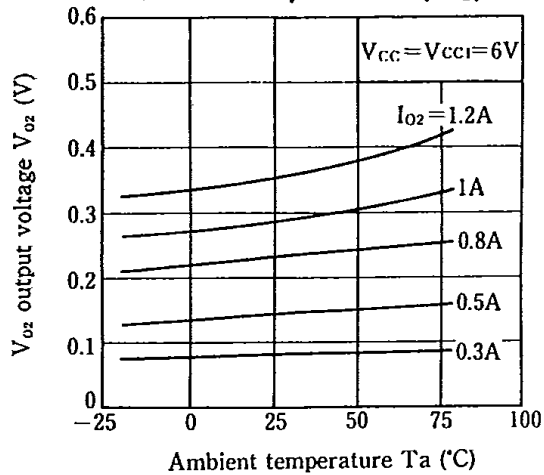

Fig. 10 Supply Current vs. Supply Voltage

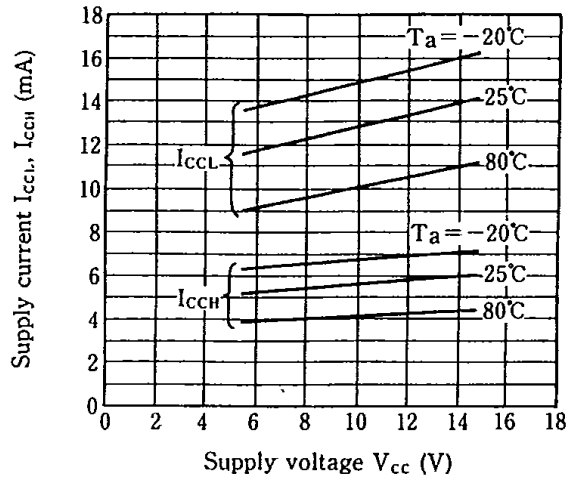

Fig. 11 Propagation Time vs. Forward Current

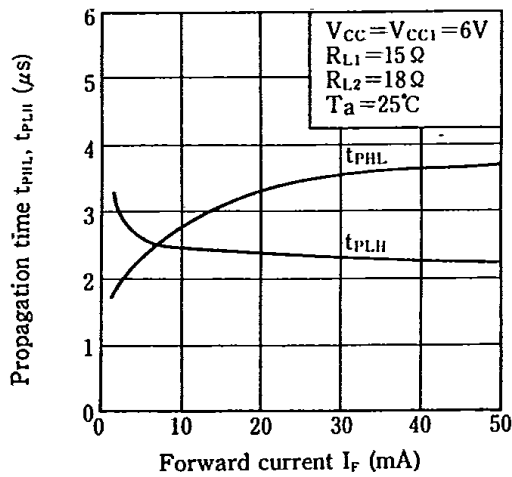
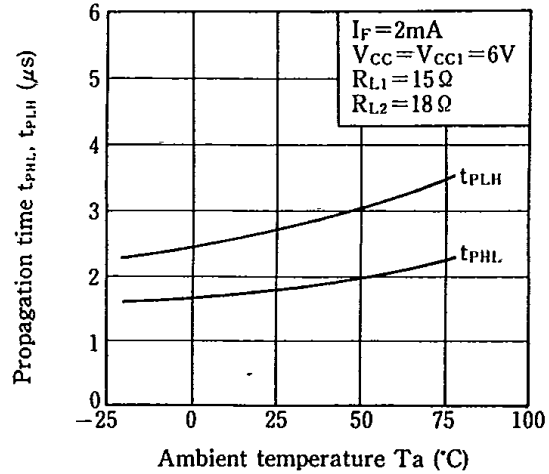

Fig. 12 Propagation Time vs. Ambient Temperature



6

Application Circuit Example

