



Micro Commercial Components
 21201 Itasca Street Chatsworth
 CA 91311
 Phone: (818) 701-4933
 Fax: (818) 701-4939

MMBD4448

Features

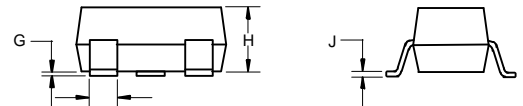
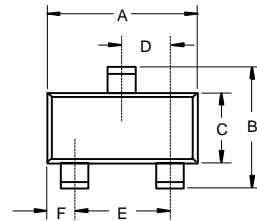
- Fast Switching Speed
- Surface Mount Package Ideally Suited for Automatic Insertion
- For General Purpose Switching Applications
- High Conductance

Surface Mount Schottky Barrier Switching Diode 350mW

Mechanical Data

- Case: SOT-23, Molded Plastic
- Terminals: Solderable per MIL-STD-202, Method 208
- Polarity: See Diagram
- Marking: KA3

SOT-23



Maximum Ratings @ 25°C Unless Otherwise Specified

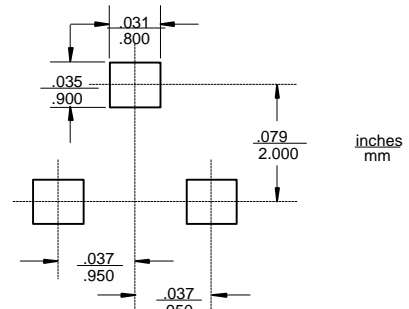
Characteristic	Symbol	Value	Unit
Non-Repetitive Peak Reverse Volt.	V_{RM}	100	V
Peak Repetitive Reverse Voltage	V_{RRM}		
Working Peak Reverse Voltage	V_{RWM}	75	V
DC Blocking Voltage	V_R		
RMS Reverse Voltage	$V_{R(RMS)}$	53	V
Forward Continuous Current(Note1)	I_{FM}	500	mA
Average Rectified Output Current	I_o	250	mA
Non-Repetitive Peak @ $t \leq 1.0s$	I_{FSM}	2	A
Forward Surge Current @ $t = 1.0us$		4	A
Power Dissipation(Note 1)	P_d	350	mW
Thermal Resistance(Note 1)	R	357	K/W
Operation/Storage Temp. Range	T_j, T_{STG}	-55 to +150	°C

DIM	INCHES		MM		NOTE
	MIN	MAX	MIN	MAX	
A	.110	.120	2.80	3.04	
B	.083	.098	2.10	2.64	
C	.047	.055	1.20	1.40	
D	.035	.041	.89	1.03	
E	.070	.081	1.78	2.05	
F	.018	.024	.45	.60	
G	.0005	.0039	.013	.100	
H	.035	.044	.89	1.12	
J	.003	.007	.085	.180	
K	.015	.020	.37	.51	

Electrical Characteristics @ 25°C Unless Otherwise Specified

Charateristic	Symbol	Min	Max	Unit	Test Cond.
Maximum Forward Voltage Drop	V_{FM}	0.62	0.72	V	$I_F=5.0mA$ $I_F=10mA$ $I_F=100mA$ $I_F=150mA$
Maximum Peak Reverse Current	I_{RM}		2.5	uA	$V_R=75V$
			50	uA	$V_R=75V T_j=150^\circ C$
			30	uA	$V_R=25V T_j=150^\circ C$
			25	nA	$V_R=20V$
Junction Capacitance	C_j		4	pF	$V_R=0V, f=1.0MHz$
Reverse Recovery Time	t_{rr}		4	ns	

Suggested Solder Pad Layout

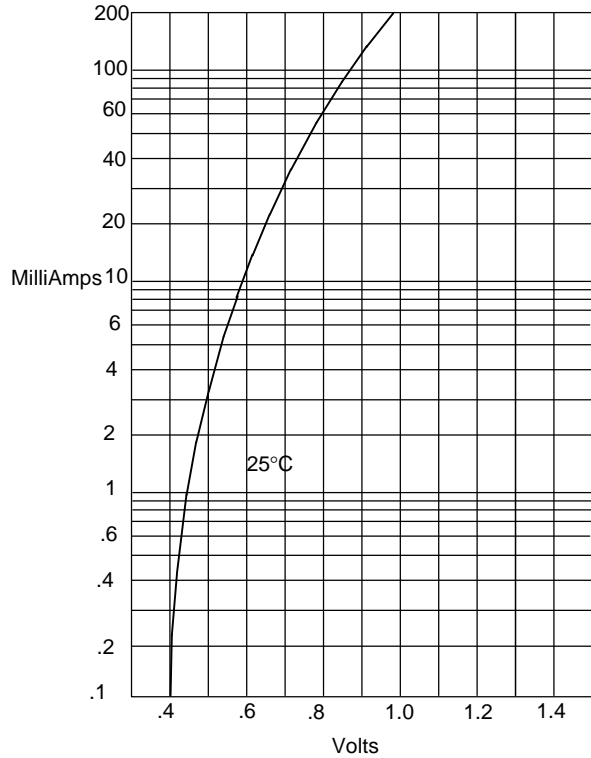


Note: 1. Valid provided that terminals are kept at ambient temperature
 2. T_{rr} Test Condition: $I_F=I_R=10mA, I_{rr}=0.1 \cdot I_R, R=100 \text{ OHM}$

MMBD4448

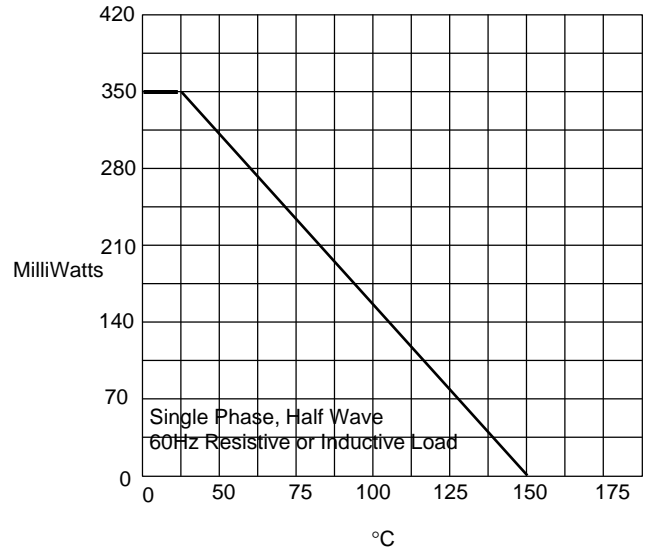


Figure 1
Typical Forward Characteristics



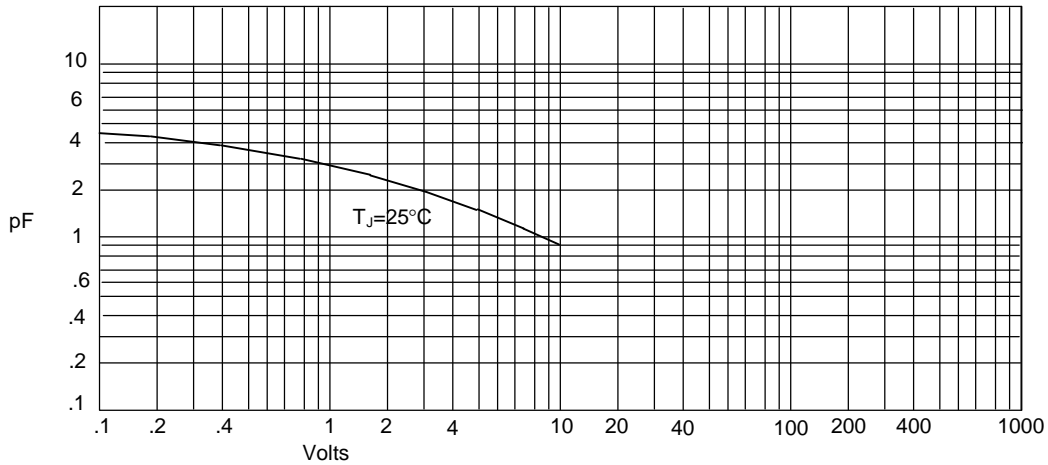
Instantaneous Forward Current - Amperes *versus*
Instantaneous Forward Voltage - Volts

Figure 2
Forward Derating Curve



Admissible Power Dissipation - MilliWatts *versus*
Ambient Temperature - °C

Figure 3
Junction Capacitance

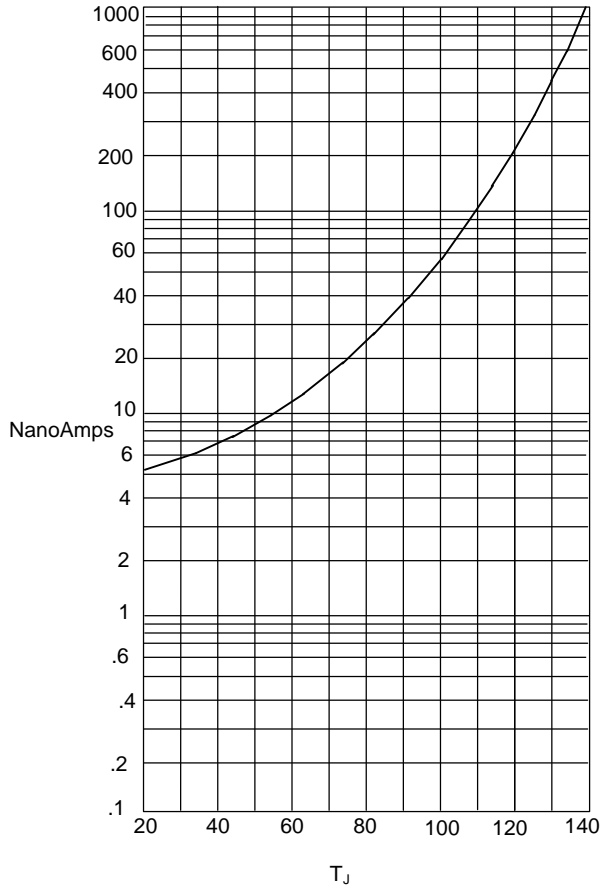


Junction Capacitance - pF *versus*
Reverse Voltage - Volts

MMBD4448



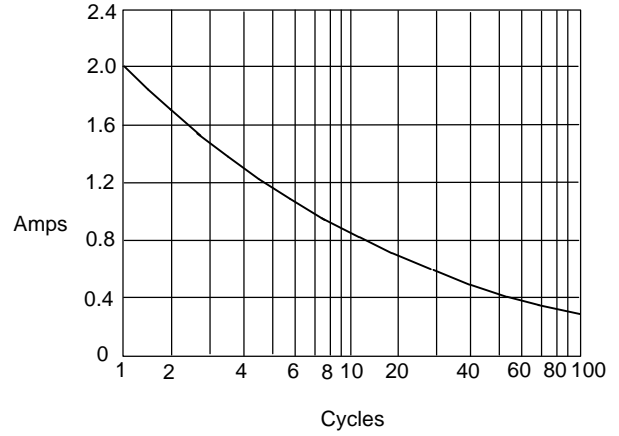
Figure 4
Typical Reverse Characteristics



Instantaneous Reverse Leakage Current - NanoAmperes versus
Junction Temperature - °C

T_A=25°C
T_A=100°C

Figure 5
Peak Forward Surge Current



Peak Forward Surge Current - Amperes versus
Number Of Cycles At 60Hz - Cycles