

High IIP3 PIN Diode Variable Attenuator
1.70-2.00 GHz

MA4VAT2007-1061T
V2

Features

- RoHs and ELV compliant
- Bandwidth: 1.70 GHz to 2.00 GHz
- 1.4 dB Insertion Loss, Typical
- 1.4:1 VSWR, Typical
- 23 dB Attenuation, Typical
- 50 dBm Input IP3, Typical (1 MHz Offset, @ + 0 dBm Pinc)
- 0 - 2.77 Volts Control Voltage @ 3 mA Typical

Extra Features

- Covers the following Bands:
 - DCS
 - PCS
 - UMTS/WCDMA/CDMA
 - TD-S_CDMA
 - SCDMA
- Usable Bandwidth: 1.50 GHz to 2.50 GHz
- 2.0 dB Insertion Loss, Typical
- 2:1 VSWR, Typical
- 18.5 dB Attenuation, Typical

Description and Applications

M/A-COM's MA4VAT2007-1061T is a HMIC PIN Diode Variable Attenuator which utilizes an integrated 90 degree 3dB hybrid with a pair of Silicon PIN Diodes to perform the required attenuation function as D.C. Voltage (Current) is applied.

This device operates from 0 to 2.77 Volts at 3.0mA typical control current for maximum attenuation. The user can add external biasing resistors to the bias ports for higher voltage requirements as required.

M/A-COM's MA4VAT2007-1061T PIN Diode Variable Attenuator is designed for AGC Circuit Applications requiring:

- Lower Insertion Loss
- Lower distortion through attenuation
- Large dynamic range for wide spread spectrum applications

PIN Configuration (Topview)

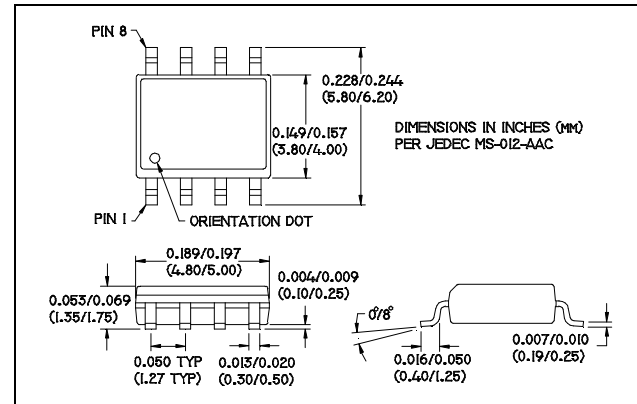

PIN Configuration (Topview)

PIN	Function	Comments
1	DC1	
2	GND	
3	GND	
4	RFin/out	Symmetrical as RF Input/Ouput
5	RFout/in	Symmetrical as RF Input/Ouput
6	GND	
7	GND	
8	DC2	

Absolute Maximum Ratings^{1,2}
@ T = +25 °C

Parameter	Maximum Ratings
Operating Temperature	-40 °C to +85 °C
Storage Temperature	-65 °C to +150 °C
Junction Temperature	+175 °C
RF C.W. Incident Power	+33 dBm C.W.
Reversed Current @ -30 V	I -50nA I
Control Current	50mA per Diode

1. All the above are at Room Temperature except as noted
2. Exceeding the above Limits may cause permanent damage

**High IIP3 PIN Diode Variable Attenuator
1.70-2.00 GHz**

**MA4VAT2007-1061T
V2**

Electrical Specifications @ +25 °C

Parameter	Frequency Band	Unit	Min	Typ	Max
No DC Bias Low Loss State (Pin = +10dBm, except for P1dB, & IP3)					
Insertion Loss	1.70 GHz – 2.00 GHz	dB	-	1.4	1.6
Input Return Loss		dB	13	15	-
Output Return Loss		dB	13	15	-
P1dB		dBm	33	-	-
IIP3		dBm	50	52	-
Control Voltage		V	-	0V @ 0uA	-
DC Bias RF Attenuation State (Pin = +10dBm, except for P1dB, & IP3)					
Maximum Attenuation	1.70 GHz – 2.00 GHz	dB	21	24	26
Input Return Loss @ Max Attenuation		dB	19	21	-
Output Return Loss @ Max Attenuation		dB	19	21	-
Input IP3		dBm	40	42	-
Control Voltage @ Max Attenuation		V	-	2.77V @ 3.00mA	-

Typical RF Performance Over Industry Designated RF Frequency Bands

Band		Freq	I. Loss	Att.	R. Loss	IIP3	Phase -Relative-
		(MHz)	(dB)	(dB)	(dB)	(dBm)	(Degree)
DCS	RX	1710-1785	1.6	22	13	50	+15°
	TX	1805-1880	1.6	22	13	50	
PCS	RX	1850-1910	1.6	21	13	50	+10°
	TX	1930-1990	1.6	21	13	50	
UMTS	RX	1920-1980	1.6	20	13	50	-5°
WCDMA/CDMA	TX	2110-2170	1.8	20	13	50	
TD-S-CDMA	-	2010-2025	1.7	20	13	50	-2°
SCDMA	-	1800-2200	1.8	20	13	50	-10°

1. All are typical values only.
2. Relative phase is the measured Insertion Phase Difference between Insertion Loss and the 20dB Attenuation State.
(Please refer to the plots below)

**High IIP3 PIN Diode Variable Attenuator
1.70-2.00 GHz**

**MA4VAT2007-1061T
V2**

Plots of Typical RF Characteristics @ + 25 °C

Typical Insertion Loss & Attenuation Plot

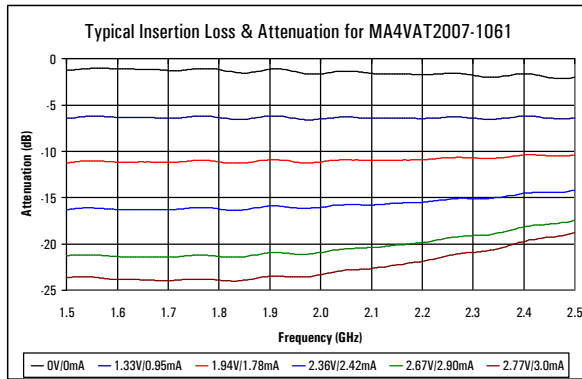

Typical Attenuation Vs Voltage Plot

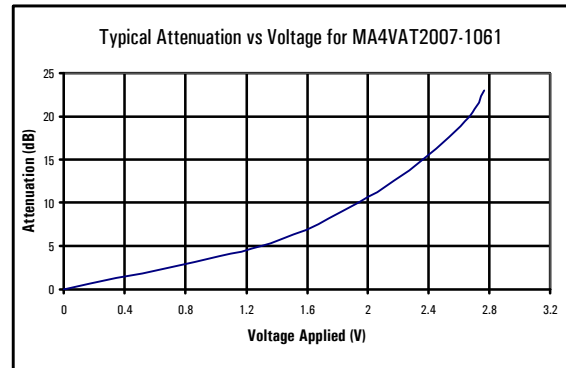

Typical Return Loss @ All Attenuation Levels Plot

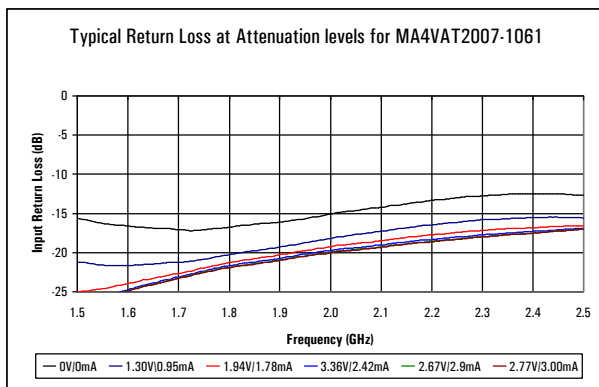

Typical IIP3 Vs Attenuation Plot

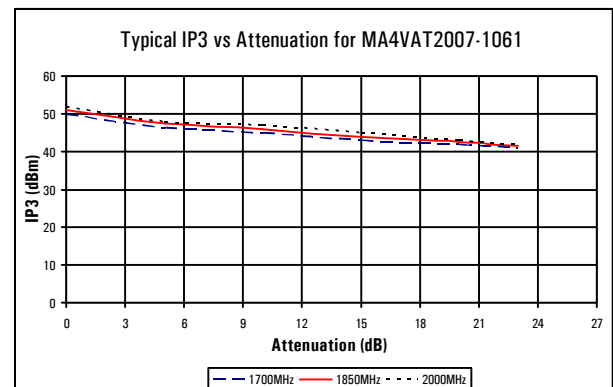

Typical Relative Phase Shift Per Attenuation (Voltage) Plot

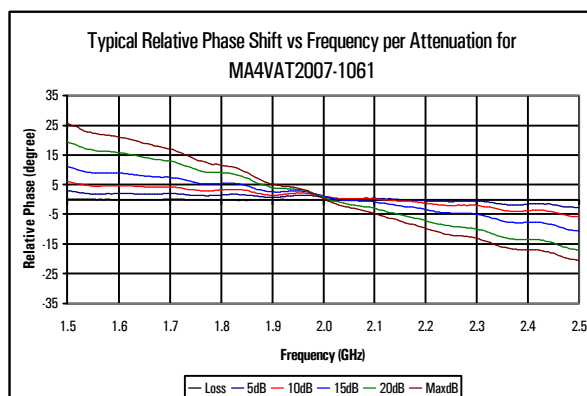

For Reference ONLY:

- Low Loss = 0.00V, @0.00mA
- 5 dB Attenuation = 1.30V, @0.95mA
- 10 dB Attenuation = 1.94V, @1.78mA
- 15 dB Attenuation = 2.36V, @2.42mA
- 20 dB Attenuation = 2.67V, @2.90mA
- Max Attenuation = 2.77V, @3.00mA

**High IIP3 PIN Diode Variable Attenuator
1.70-2.00 GHz**

**MA4VAT2007-1061T
V2**

Package Pin Designation, External Components, and Equivalent Circuit

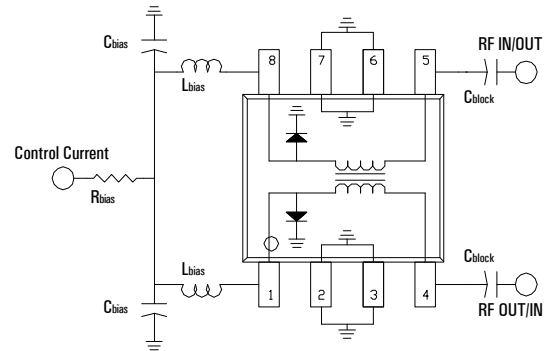
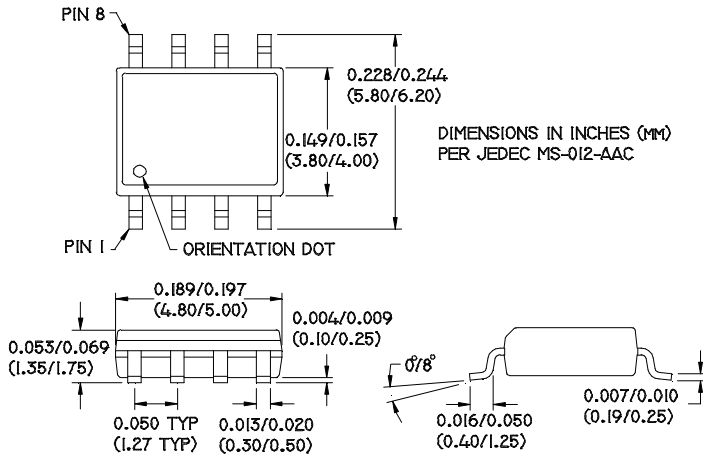

External Bias Components

Rbias= 680 Ohms (2.77 V, 3.0 mA)
Lbias= 150 nH
Cbias =100 pF
Cblock =100 pF

Ordering Information

Part Number	Package
MA4VAT2007-1061T	Tape and Reel