

Power LED Driver the Smallest and Low Profile, Constant Current Source 0 - 2.0A, 2.5V to 7V, with 450W/in³ Power Density and High Efficiency



FEATURES

- Fully integrated Power LED driver
- High efficiency over large load range
- 100% duty cycle
- Power density - more than 450W/inch³
- 1µA shutdown current
- Variable input voltage 2.5V to 6V (1Li+ or 3-cell NiCd or NiMH cells)
- Controlled output current
- Programmable PWM/ $\overline{\text{PSM}}$ controls
- Low output ripple
- BGA construction
- Temperature range: - 40°C to + 85°C
- No external components required
- Output power 15W
- Maximum current 2.5A
- Short circuit protection
- Low profile

The Power LED Driver is dedicated for optimum performance to drive Power LED's. FX5959 is a complete system solution for all Power LED's with high current for e.g. > 300mA. The driver provides a constant current without exceeding the applicable LED voltage to ensure the specified LED load life time. The integrated Current Source provides flexibility of utilizing various battery configurations and chemistries such as NiCd, NiMH, or Li+ with input voltage range of 2.5v to 6v. An additional flexibility is provided by using external resistors to adapt to various voltage input levels and LED configurations. For ultra-high efficiency, the Power LED Driver is designed to operate in synchronous rectified PWM mode under full load while transforming into externally controlled pulse-skipping mode (PSM) under light load (e.g. for LED's with 20 to 200mA).

The FX5959 Current Source is available in 25-ports BGA package. In order to satisfy the stringent ambient temperature requirements, the Current Source is designed to handle the industrial temperature range of - 40°C to 85°C.

APPLICATION

- Bike lamps
- Headlights and flashlights
- Medical instrumentation
- General and emergency/alarm lighting
- Design and architectural lighting
- Interior and runway lights
- Outdoor accent lighting
- Household appliances

ORDERING INFORMATION

	FX	5959	G701	ADJ	<input type="checkbox"/>	<input type="checkbox"/>
FUNCTION						
SIZE						
CIRCUIT IDENTIFIER						
OUTPUT VOLTAGE - ADJ for adjustable version - self selectable output voltage. (see note below)						
PACKAGING - B1 = 10pcs in bulk; B5 = 50pcs in bulk; T5 = 500pcs in 13" ree.						
For lead (Pb)-free solder please add E2 suffix.						

* Note: for fixed output current please contact FunctionPAK@vishay.com

DIMENSIONS in inches [millimeters]	
L	0.59 ± 0.01 [15 ± 0.25]
A	0.1 ± 0.01 [2.54 ± 0.25]
B	0.95 ± 0.01 [2.29 ± 0.25]
T	0.126 max [3.2 max]
Ball Diameter	0.03 ± 0.001 [0.762 ± 0.025]

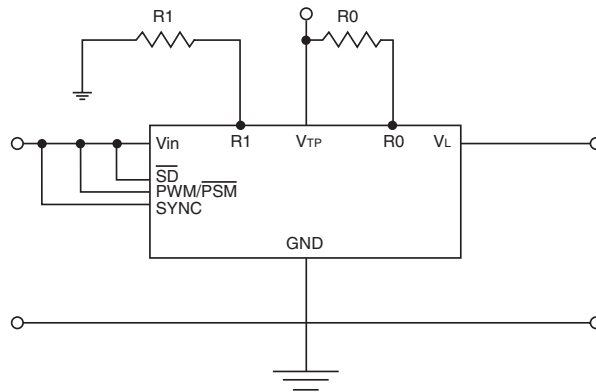
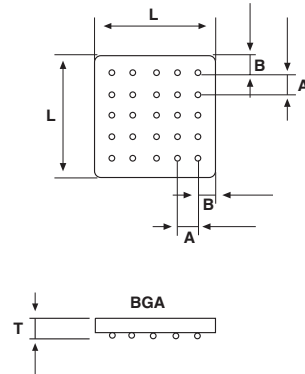

UPPER SIDE

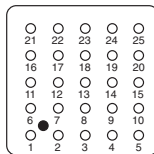

PIN CONFIGURATION*	
PIN	CONNECTION
4, 5	Vin
9, 14	SD*
10, 15	PWM/PSM*
20, 25	SYNC*
1-3, 7, 8, 13, 18, 23	GND
19, 24	R1 _{ext}
21, 22	V _{TP}
16, 17	R0 _{ext}
6, 11, 12	Load

*Note: must be connected to Vin.

RECOMMENDED PAD PATTERN in inches [millimeters]		
A	D	F
0.1 ± 0.01 [2.54 ± 0.25]	0.03 ± 0.001 [0.8 ± 0.02]	0.02 ± 0.001 [0.5 ± 0.02]

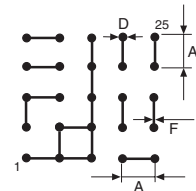

STANDARD ELECTRICAL SPECIFICATIONS					
PARAMETER	UNIT	CONDITION	MIN	TYP	MAX
Input					
Voltage Range	V_{DC}		2.5		6.0
Quiescent Current	μA	PSM mode		200	
Soft Start Time	ms	T_{SS} for $V_{out} = 6.0V$		22	
	ms	T_{SS} for $V_{out} = 5.0V$		22	
	ms	T_{SS} for $V_{out} = 3.3V$		19	
SD, PWM/PSM, SYNC					
Logic High	V	V_H	2.4		
Logic Low	V	V_L			0.8
Normal Mode	μA	I_{DD}			750
PSM Mode	μA	I_{DD}			250
Shutdown Mode	μA	I_{DD}			1
Shutdown Time	ms	T_{SS} for $V_{out} = 6.0V$		15	
	ms	T_{SS} for $V_{out} = 5.0V$		14	
	ms	T_{SS} for $V_{out} = 3.3V$		14	
Insulation					
Test Voltage	V_{AC}	60Hz 60sec	750		
Resistance	Ω	$V_{ISO} = 500 V_{DC}$	1×10^{11}		
Leakage Current	nA	$V_{ISO} = 500 V_{DC}$			5
Output					
$(V_{TP} - V_L) L_{OUT}$	W	at 25 °C Ambient Temperature			1.5
	W	at 85 °C Ambient Temperature			0.8
Power	W			15	
Voltage	V_{DC}				7
Current Tolerance	%	at 25 °C Ambient Temperature		± 10	
Temp. Coefficient	%/°C				0.03
Ripple and Noise	mVpp	DC to 20 MHz		45	
General					
Package Weight	gr.				1.65
Oscillator					
Frequency	KHz			670	
SYNC Range		F_{SYNC}/F_{OSC}	1.2		1.5
Temperature					
Operation	°C		- 40		+ 85
Storage	°C		- 55		+ 125
Operating Junction Temp.	°C	T_j		150	
Thermal Impedance	°C/W _D *	θ_{JA}		82	

*Note: W_D = Power Dissipated

Rise Time

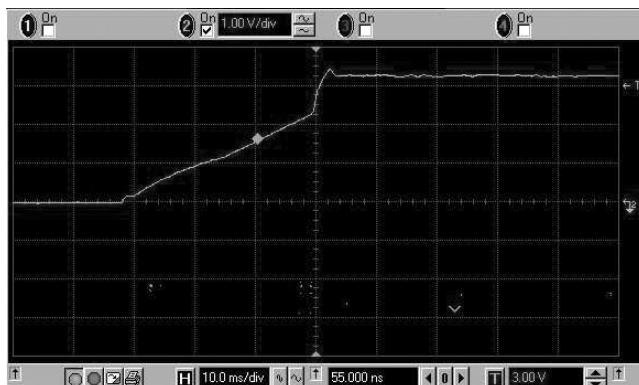

Rise Time (PWM mode): $V_{in} = 3V$; $V_{TP} = 3.3V$; $I_{out} = 2.5A$

Fall Time

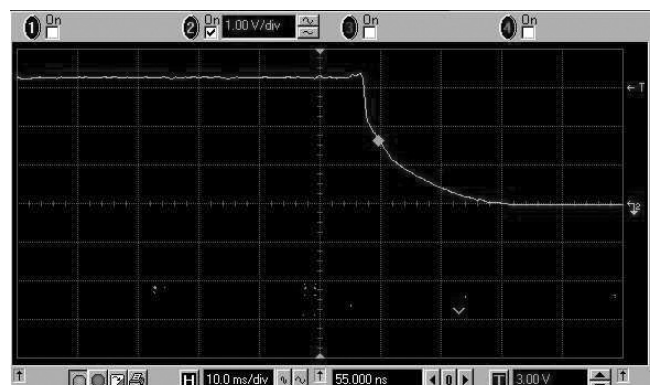

Fall Time (PWM mode): $V_{in} = 3V$; $V_{TP} = 3.3V$; $I_{out} = 2.5A$

Rise Time

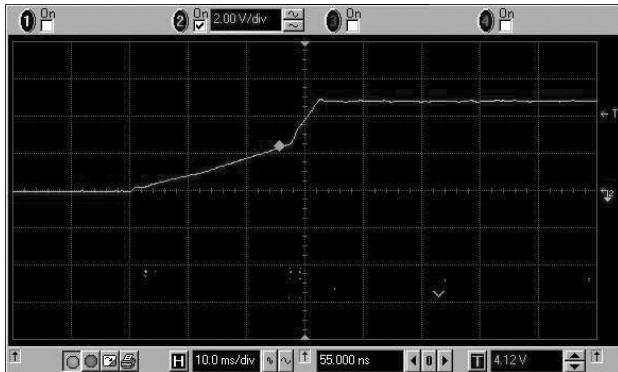

Rise Time (PWM mode): $V_{in} = 4.5V$; $V_{TP} = 5V$; $I_{out} = 2A$

Fall Time

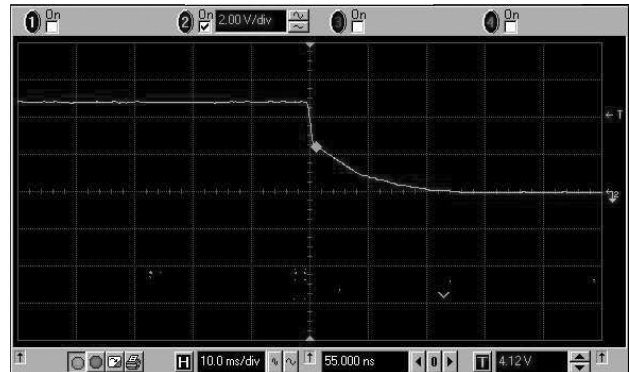

Fall Time (PWM mode): $V_{in} = 4.5V$; $V_{TP} = 5V$; $I_{out} = 2A$

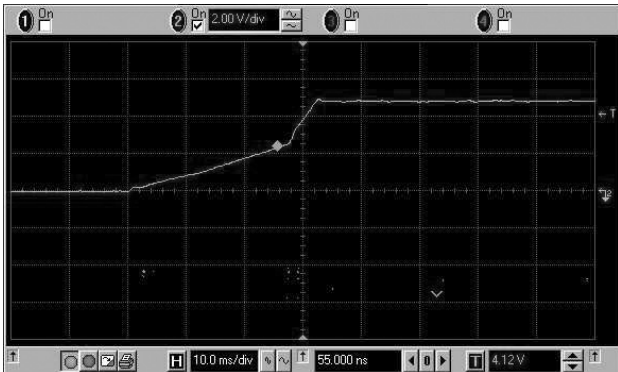

Rise Time (PWM mode): $V_{in} = 3.5V$; $V_{TP} = 5V$; $I_{out} = 2A$

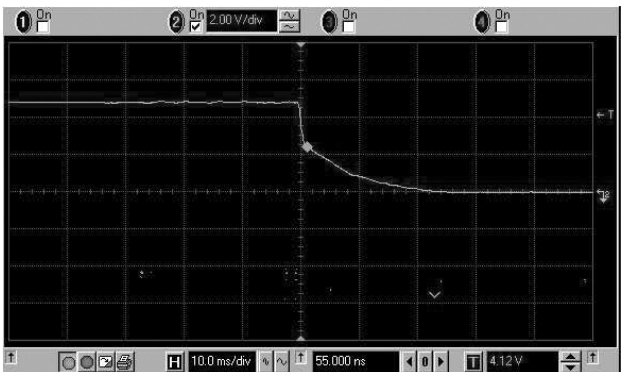

Fall Time (PWM mode): $V_{in} = 3.5V$; $V_{TP} = 5V$; $I_{out} = 2A$

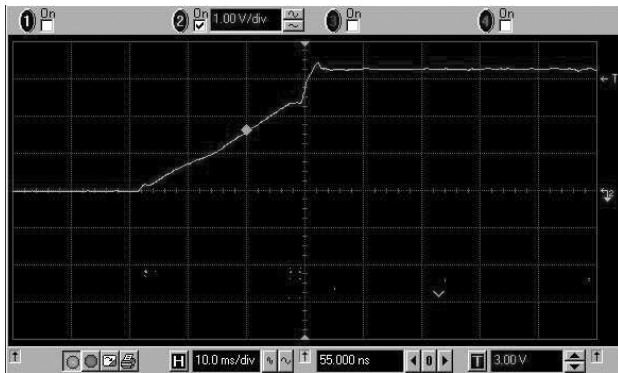

Rise Time (PWM mode): $V_{in} = 3V$; $V_{TP} = 3.3V$; $I_{out} = 2A$

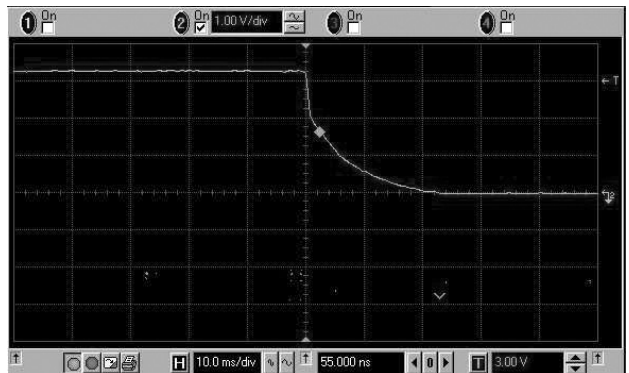

Fall Time (PWM mode): $V_{in} = 3V$; $V_{TP} = 3.3V$; $I_{out} = 2A$

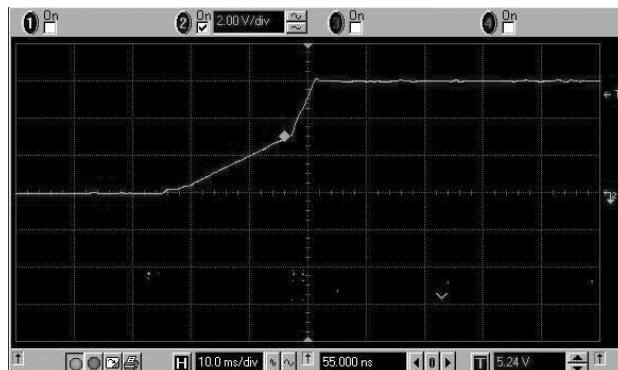

Rise Time (PWM mode): $V_{in} = 5V$; $V_{TP} = 6V$; $I_{out} = 1A$

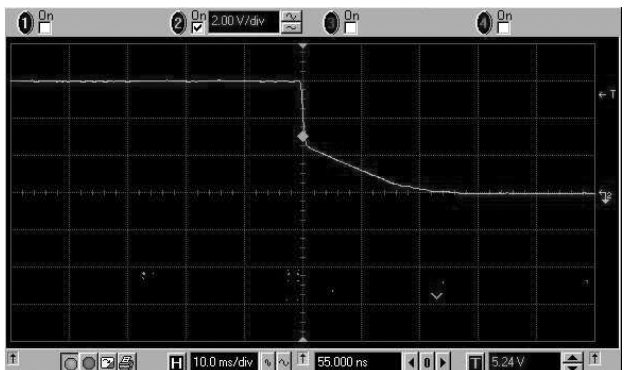

Fall Time (PWM mode): $V_{in} = 5V$; $V_{TP} = 6V$; $I_{out} = 1A$

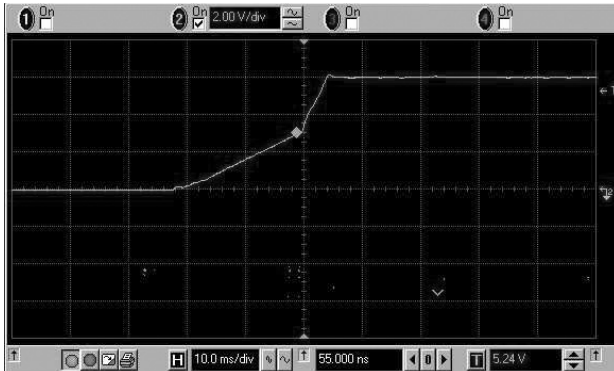
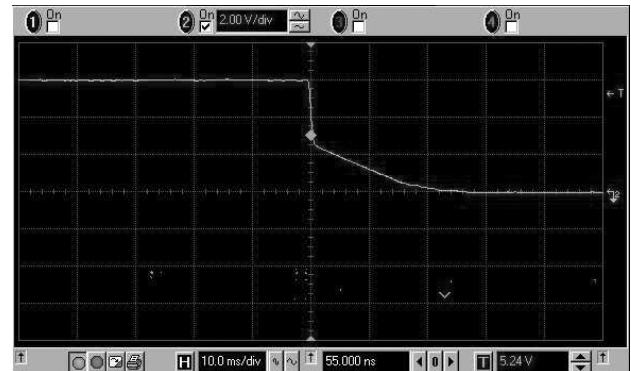
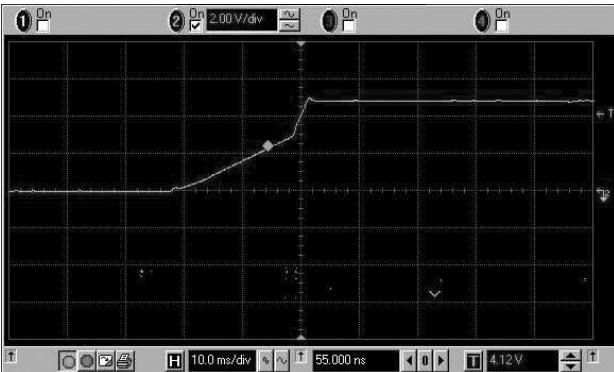
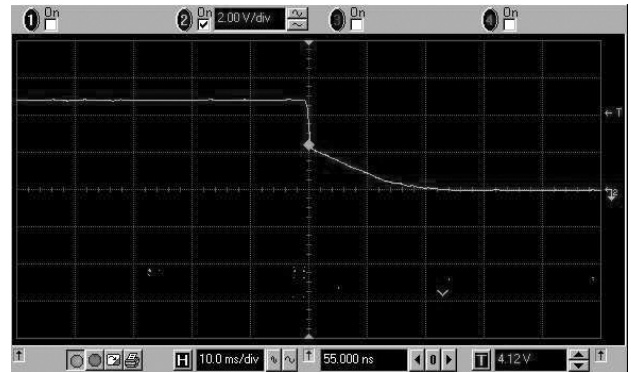
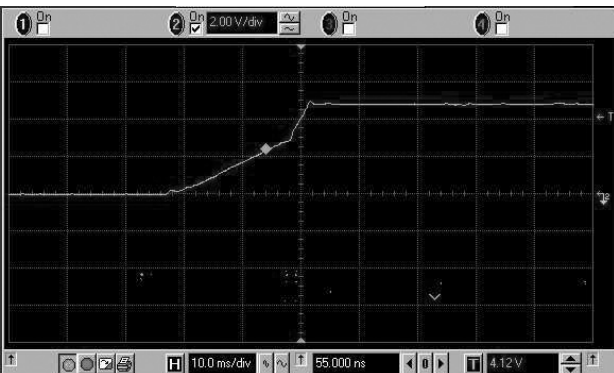
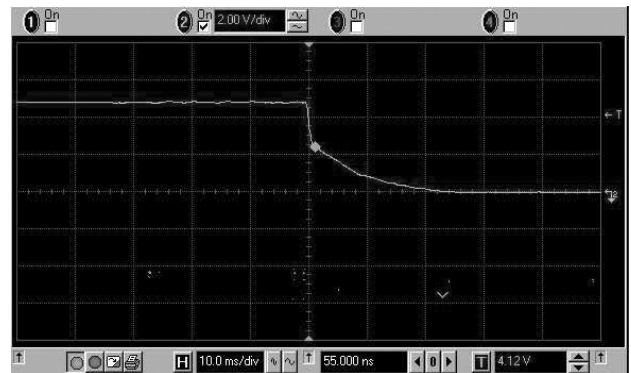
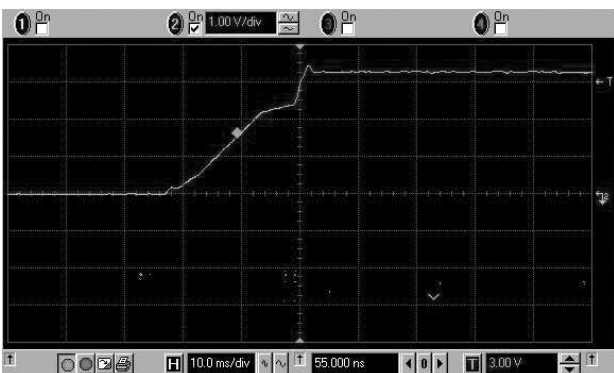
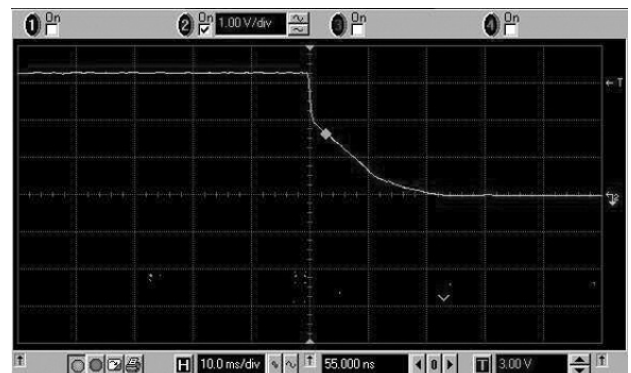
Rise Time

Rise Time (PWM mode): $V_{in} = 4V$; $V_{TP} = 6V$; $I_{out} = 1A$
Fall Time

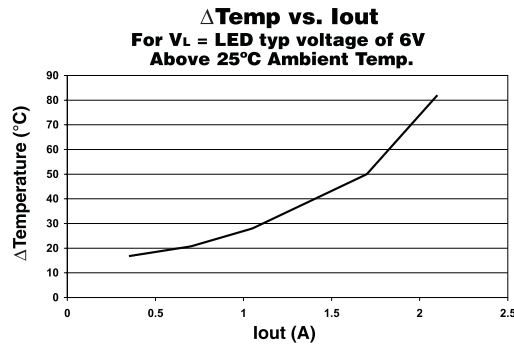
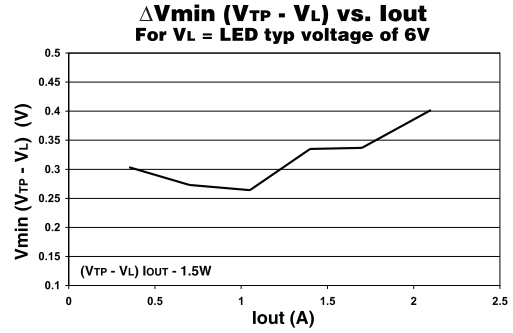
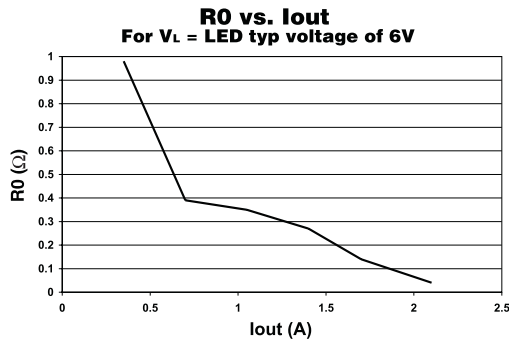
Fall Time (PWM mode): $V_{in} = 4V$; $V_{TP} = 6V$; $I_{out} = 1A$

Rise Time (PWM mode): $V_{in} = 4.5V$; $V_{TP} = 5V$; $I_{out} = 1A$

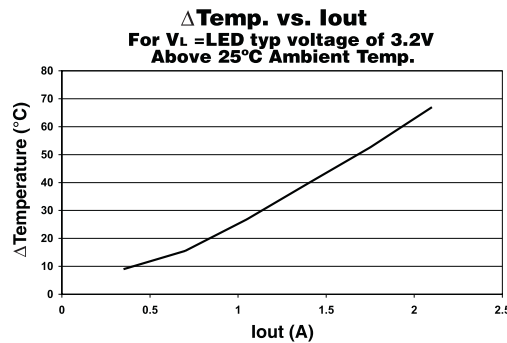
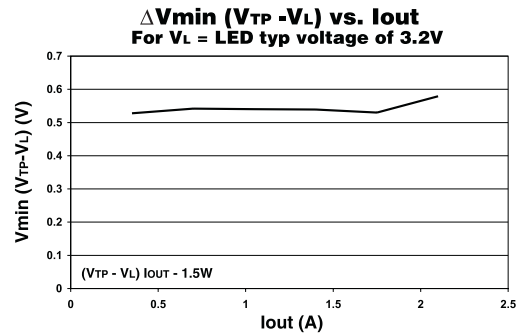
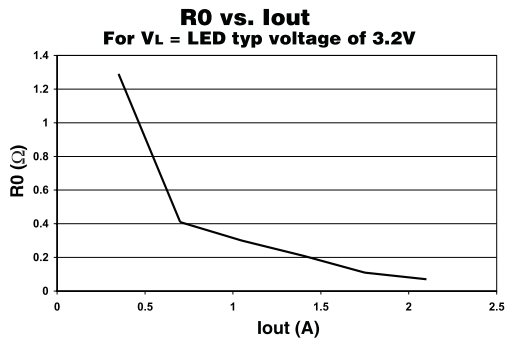
Fall Time (PWM mode): $V_{in} = 4.5V$; $V_{TP} = 5V$; $I_{out} = 1A$

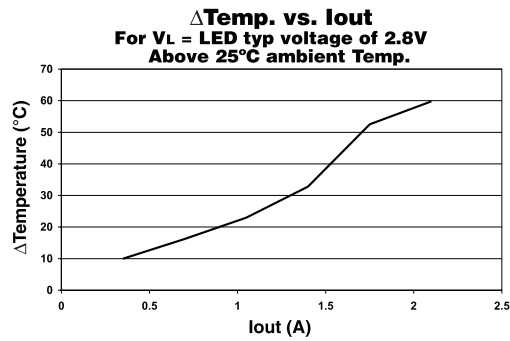
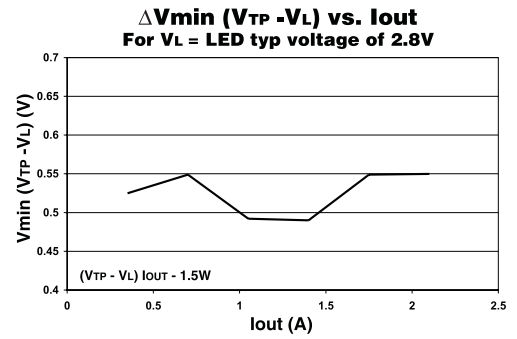
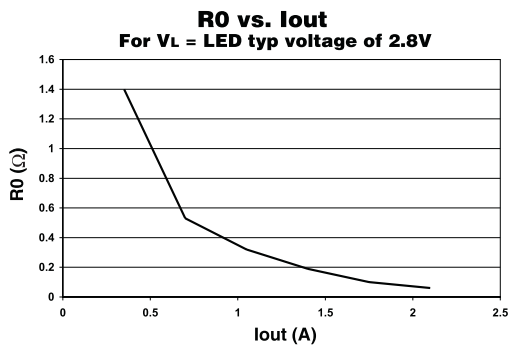
Rise Time (PWM mode): $V_{in} = 3.5V$; $V_{TP} = 5V$; $I_{out} = 1A$

Fall Time (PWM mode): $V_{in} = 3.5V$; $V_{TP} = 5V$; $I_{out} = 1A$

Rise Time (PWM mode): $V_{in} = 3V$; $V_{TP} = 3.3V$; $I_{out} = 1A$

Fall Time (PWM mode): $V_{in} = 3V$; $V_{TP} = 3.3V$; $I_{out} = 1A$

PWM MODE FOR 6V LED



PWM MODE FOR 3.2V LED



PWM MODE 2.8V LED

PIN DESCRIPTION

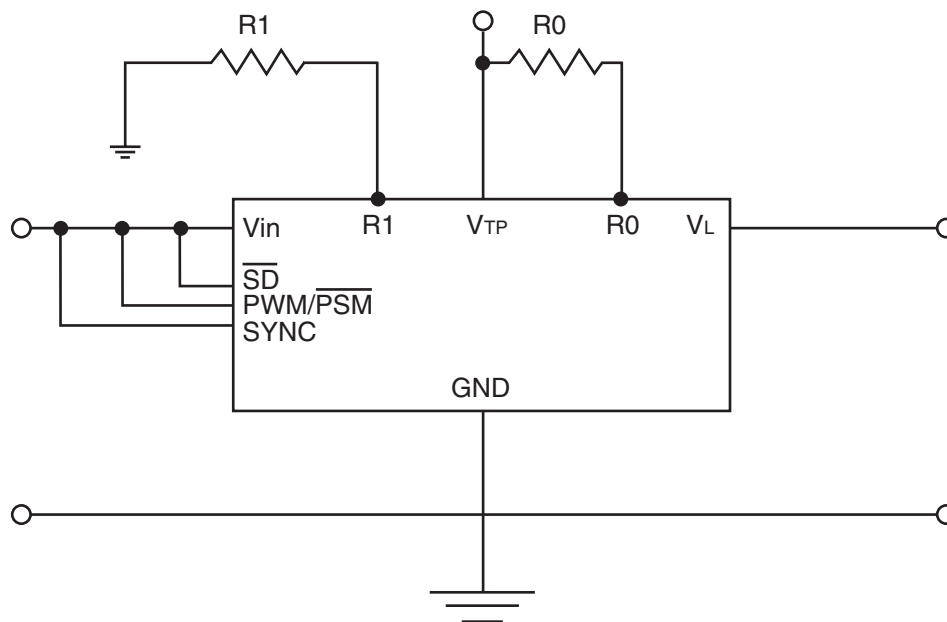

PIN	DESCRIPTION
\overline{SD}	Logic low on SD pin shuts down the Current Source completely and decreases current consumption to less than 1uA
$\overline{PWM/PSM}$	Logic high =PWM mode, logic low =PSM mode. In PSM mode synchronous rectification is disabled.
SYNC	Externally controlled synchronization signal. Logic high to low transition forces the clock synchronization. If not used must be connected to Vin or logic high.
Vin	Input supply voltage
GND	Ground
R1	Included inside the package for fixed voltage. To be added externally for all self-selected voltages.
V _{TP}	Voltage test point. To test the minimum gap above VL.
R0	To be added externally for selected output current.
V _L	Output current. LED connection

DEMONSTRATION BOARD
TEST SET-UP AND OPERATION

Pins SD (Shut Down), PWM and SYNC (Synchronization) are internally connected on the demo board to V_{in} .

1. Connect the DB according to the circuit drawing below without connecting the LED
2. Use DC power supply, with current capability of twice the output current.
3. Adjust V_{TP} with R1 trimmer to a typical voltage of 0.6V above the V_L (LED voltage).
4. Connect the LED or equivalent resistor value according to the circuit drawing below and adjust R0 trimmer to the required current.
5. Input voltage can be adjusted between 2.5V to V_{TP} .

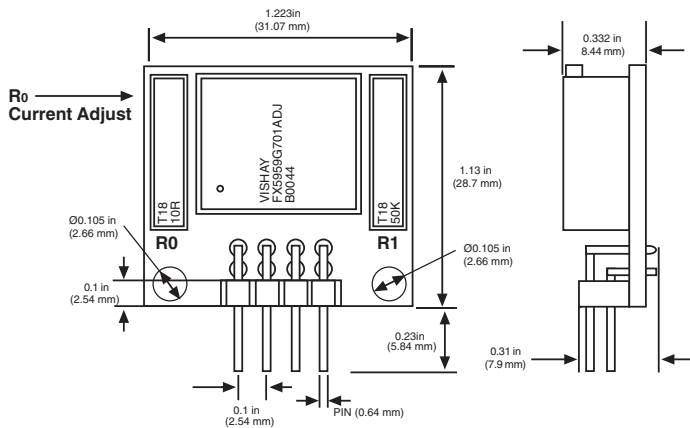
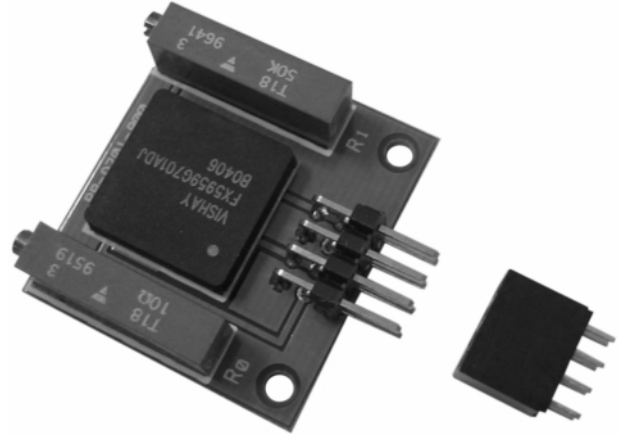
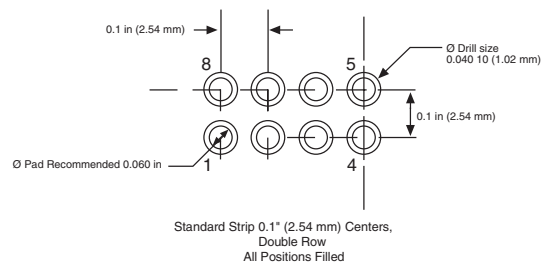
RECOMMENDED BOARD LAYOUT

View from bottom side

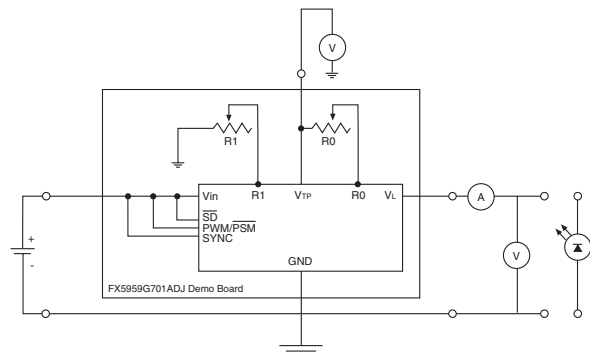
PIN No:	Description
1	GND
2	V_L
3	GND
4	V_{in}
5	V_{in}
6	GND
7	V_L
8	TP



SOLDERING PROFILE

All of the components must be dried prior to assembly as follows:

1. Samples and package type B1 and B5, bulk components - the recommended drying process is to be done at 125°C for 48 hours.
2. For package type T1 and T2 - per JEDEC J-STD-033 level5.

For taped components the recommended drying process is to be done at maximum 70°C.

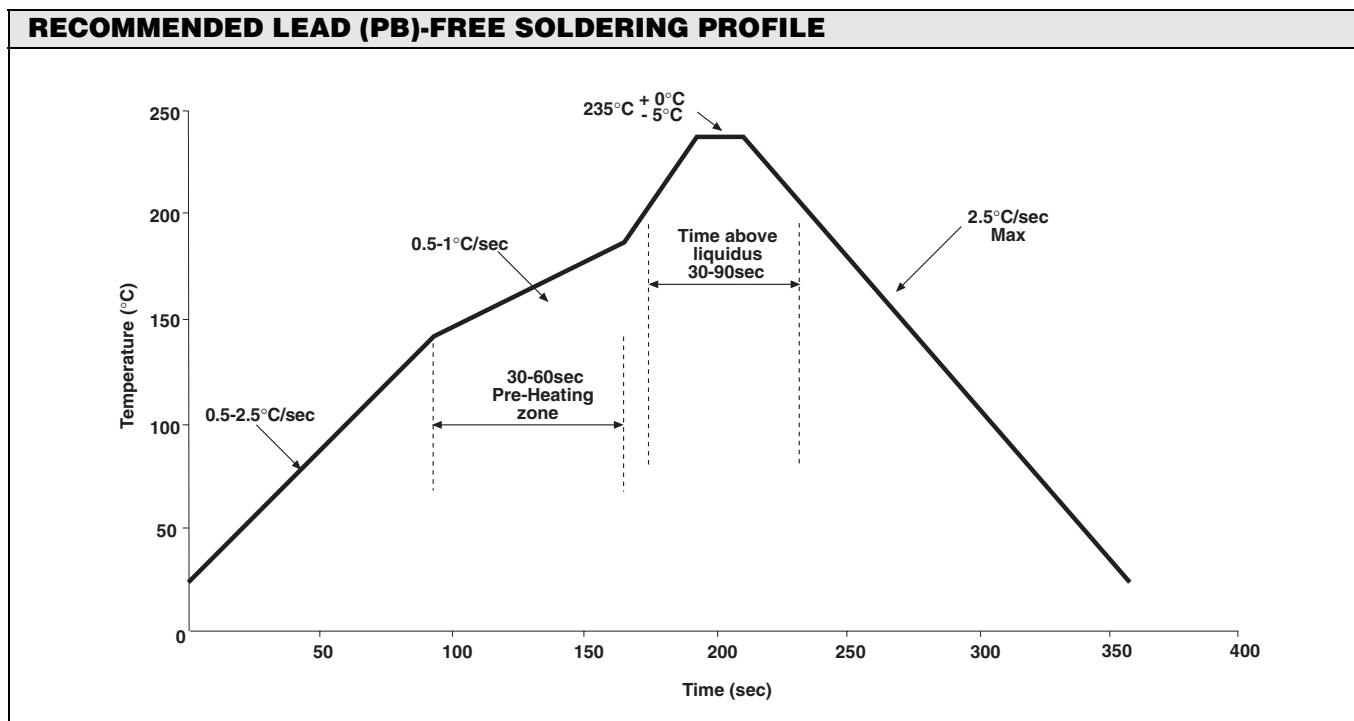
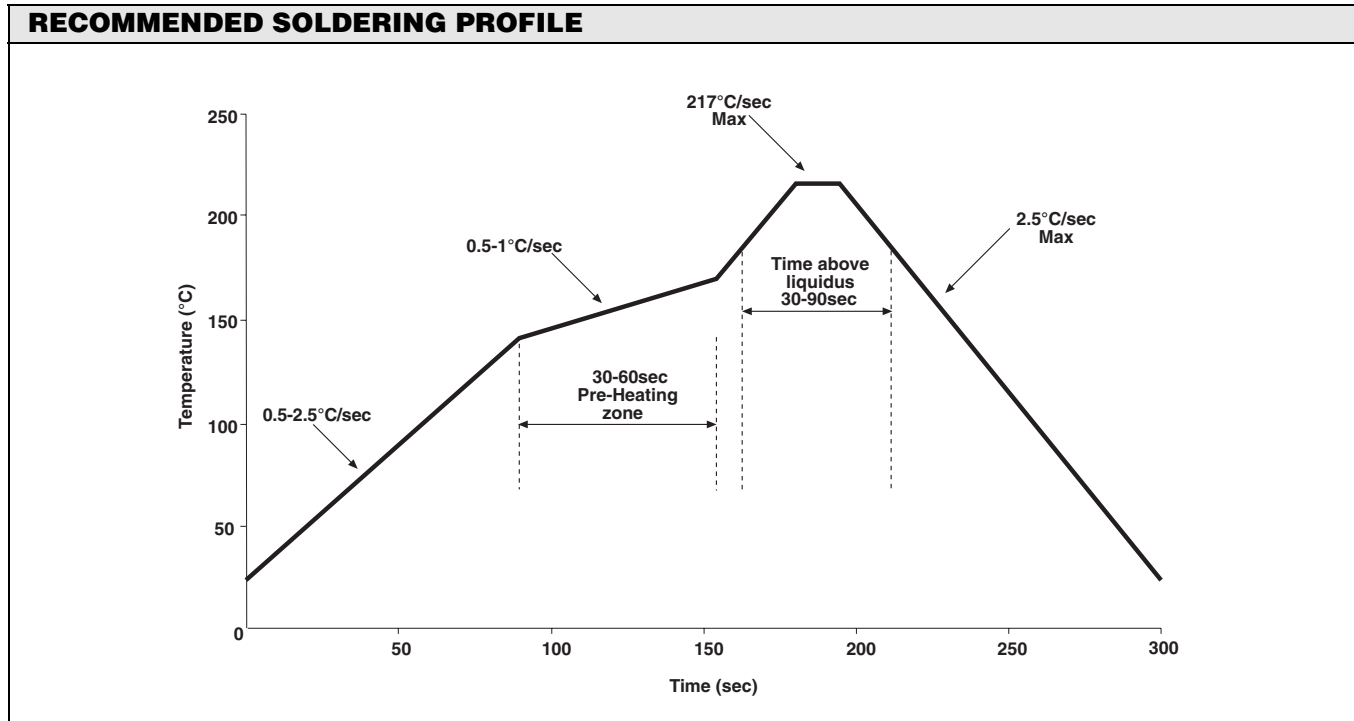

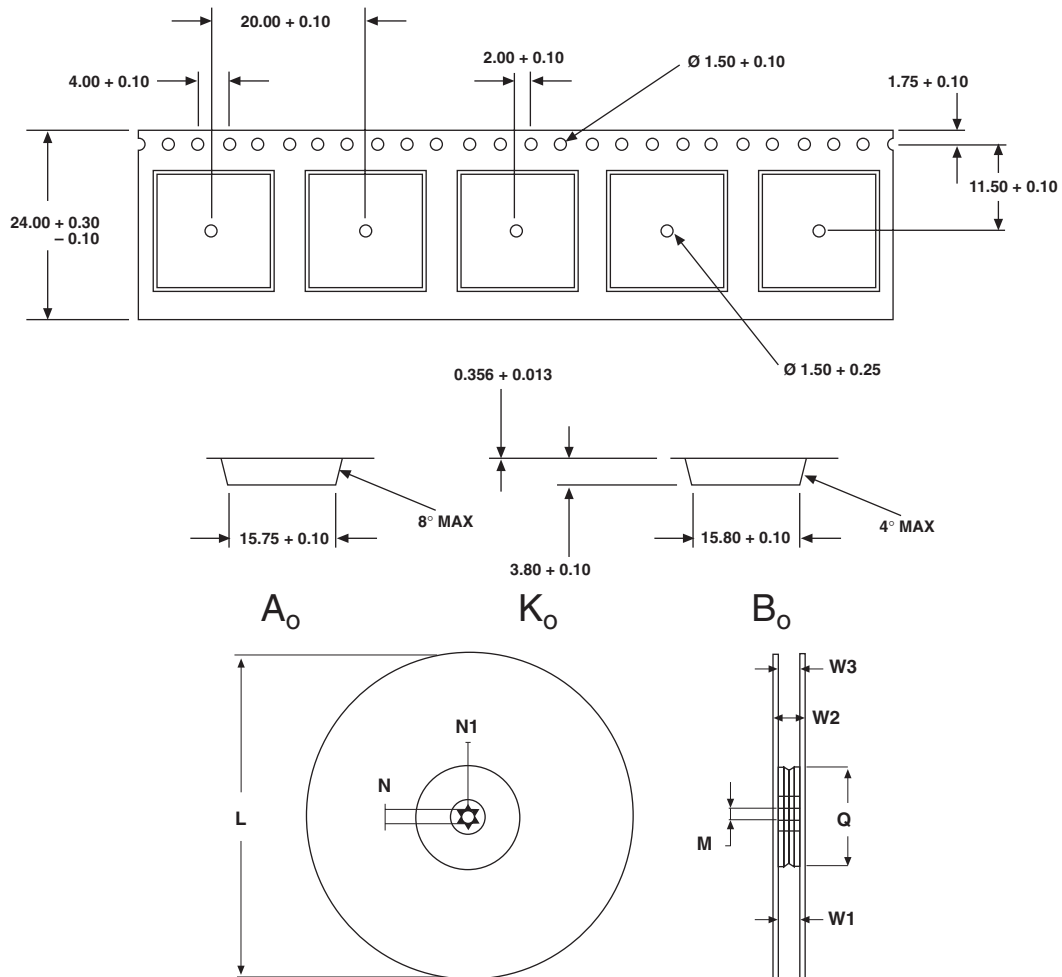
TAPE AND REEL INFORMATION
**PER STANDARD EIA-481-2-A
(REVISION OF 481-2 AND INCLUSION OF EIA-481-3)**

T5 - 13" REEL DIMENSIONS in millimeters

DIMENSION	MIN	MAX
L		330
M	12.8	13.2
N	20.2	
N1	1.5	
Q	100	
W1	24.4	26.4
W2		30.4
W3		27.4