

## 1.25 Watt Fully Differential Audio Power Amplifier

### With Internal Feedback Resistors

#### Features

- Fully differential amplifier
- Improved PSRR at 217Hz(VDD>3.0V) 86dB (typ)
- Power output at 5.0V & 1% THD 1.25W (typ)
- Power output at 3.6V & 1% THD 0.6W (typ)
- Ultra low shutdown current 0.01  $\mu$  A (typ)
- Improved pop & click circuitry eliminates noises during turn-on and turn-off transitions
- Thermal overload protection circuitry
- No output coupling capacitors, bootstrap capacitors required
- Unity-gain stable
- External gain configuration capability
- Available in space-saving package: 9-bump micro SMD and 8-pin MSOP8

#### General description

The BL6211 is a fully differential audio power amplifier designed for portable communication device applications. It is capable of delivering 1.25 watt of continuous average power to an 8 $\Omega$  BTL load with less than 1% distortion (THD+N) from a 5V battery voltage. It operates from 2.2 to 5.5V.

Features like 86dB PSRR at 217Hz, improved RF-rectification immunity, the space-saving 8-pin MSOP8 and 9-bump micro SMD package, the advanced pop & click circuitry, a minimal count of external components and low-power shutdown mode make BL6211 ideal for wireless handsets.

The BL6211 is unity-gain stable, and the gain can be configured by external input resistors and internal feedback resistors.

#### Applications

- Wireless handsets
- Portable audio devices
- PDAs, Handheld computers

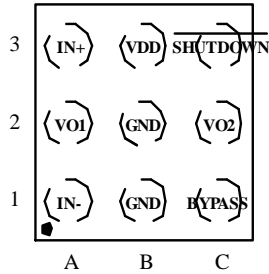
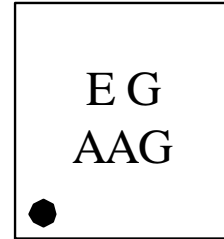
**Pin Diagram (Top View)**
**9 Bump micro SMD Package  
(Top View)**

**9 Bump micro SMD Marking**

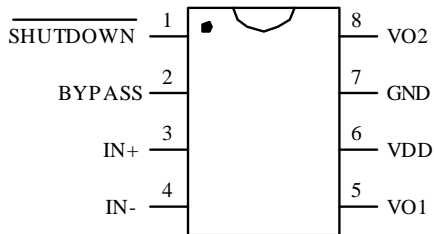
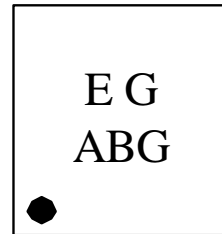
E - Die Run Traceability  
 G - Date Code  
 AAG - BL6211ITLXROHS

**Mini Small Outline (MSOP8) Package  
(Top View)**

**MSOP8 Marking**

E - Die Run Traceability  
 G - Date Code  
 ABG - BL6211MM ROHS

**Figure 1 Pin Diagram of BL6211**
**Pin Definitions and Functions**
**Table 1. Pin Definitions and Functions**

MSOP8	9-Bump micro SMD	Symbol	Type	Functions
1	C3	SHUTDOWN	I	Shutdown Pin, active low.
2	C1	BYPASS	I	Common mode voltage. Connect a bypass capacitor to GND for common mode voltage filtering. The bypass capacitor is optional.
3	A3	IN+	I	Positive differential input.
4	A1	IN-	I	Negative differential input.

MSOP8	9-Bump micro SMD	Symbol	Type	Functions
5	A2	VO1	O	Positive differential output.
6	B3	VDD	I	Power supply
7	B1,B2	GND	I	Ground.
8	C2	VO2	O	Negative differential output.

## Operation conditions and Electrical characteristics

### Operation Conditions

**Table 2. Operation Conditions**

Parameter	Symbol	Min	Typ	Max	Unit
Power Supply Voltage	$V_{DD}$	2.2		5.5	V
Operating Temperature Range	$T_A$	-40		85	°C

### Electrical Characteristics

**Table 3.  $V_{DD}=5V$  (The following specifications apply for  $8\Omega$  load,  $A_V=1V/V$ ,  $T_A=25^\circ C$ , unless otherwise specified.)**

Parameter	Symbol	Conditions	Min	Typ	Max	Unit
Quiescent Power Supply Current	$I_{DD}$	$V_{IN}=0V$ , no load		2.5	5	mA
		$V_{IN}=0V$ , $R_L=8\Omega$		4	8	
Shutdown Current	$I_{SD}$	$V_{SHUTDOWN}=GND$		0.01	1	$\mu A$
Output Power	$P_O$	THD=1%(max); $f=1kHz$		1.25		W
Total Harmonic Distortion + Noise	THD+N	$P_O=0.6W_{rms}$ ; $f=1kHz$		0.02		%
Power Supply Rejection Ratio	PSRR	Vripple=200mV sine p-p				dB
		$f=217Hz$ (note1)		-88		
		$f=1kHz$ (note1)		-83		
		$f=217Hz$ (Note2)		-83		
		$F=1KHz$ (Note2)		-83		

Parameter	Symbol	Conditions	Min	Typ	Max	Unit
Common Mode Rejection Ratio	CMRR	$f=217\text{Hz}$ $V_{\text{CM}}=200\text{mV}_{\text{PP}}$		-78		dB
Output Offset	$V_{\text{OS}}$	$V_{\text{IN}}=0\text{V}$		2	8	mV
Shutdown Voltage Input High	$V_{\text{SDIH}}$		1.5			V
Shutdown Voltage Input Low	$V_{\text{SDIL}}$				0.5	V
Closed Loop Gain	$A_{\text{V}}$		$\frac{36\text{k}\Omega}{R_{\text{i}}}$	$\frac{40\text{k}\Omega}{R_{\text{i}}}$	$\frac{44\text{k}\Omega}{R_{\text{i}}}$	V/V

**Note1:** Unterminated input

**Note2:**  $10\Omega$  terminated input

**Table 4.**  $V_{DD}=3.6V$  (The following specifications apply for  $8\ \Omega$  load,  $A_V=1V/V$ ,  $T_A=25^\circ C$ , unless otherwise specified.)

Parameter	Symbol	Conditions	Min	Typ	Max	Unit
Quiescent Power Supply Current	$I_{DD}$	$V_{IN}=0V$ , no load		2	4.5	mA
		$V_{IN}=0V$ , $R_L=8\ \Omega$		3.5	7.5	
Shutdown Current	$I_{SD}$	$V_{SHUTDOWN}=GND$		0.01	1	$\mu A$
Output Power	$P_O$	THD=1%(max); $f=1kHz$		0.6		W
Total Harmonic Distortion + Noise	THD+N	$P_O=0.4W_{rms}$ ; $f=1kHz$		0.02		%
Power Supply Rejection Ratio	PSRR	$V_{ripple}=200mV$ sine p-p				dB
		$f=217Hz$ (note1)		-86		
		$f=1kHz$ (note1)		-83		
		$f=217Hz$ (Note2)		-83		
		$F=1KHz$ (Note2)		-83		
Common Mode Rejection Ratio	CMRR	$f=217Hz$ $V_{CM}=200mV_{PP}$		-76		dB
Output Offset	$V_{OS}$	$V_{IN}=0V$		2	8	mV
Shutdown Voltage Input High	$V_{SDIH}$		1.5			V
Shutdown Voltage Input Low	$V_{SDIL}$				0.5	V
Closed Loop Gain	Gain		$\frac{36k\ \Omega}{R_i}$	$\frac{40k\ \Omega}{R_i}$	$\frac{44k\ \Omega}{R_i}$	V/V

**Note1:** unterminated input

**Note2:**  $10\ \Omega$  terminated input

**Typical characteristics**

Output Power vs Supply Voltage  
 $R_L=8\ \Omega$

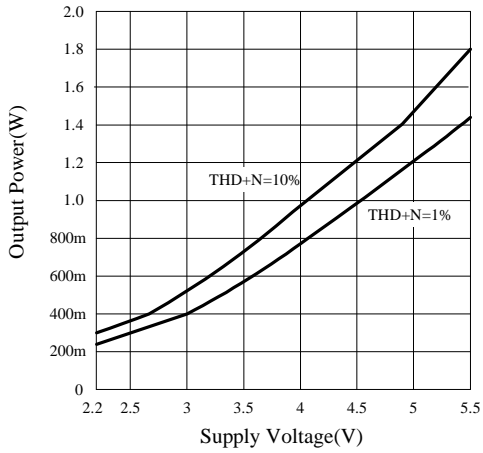

Power Dissipation vs Output Power

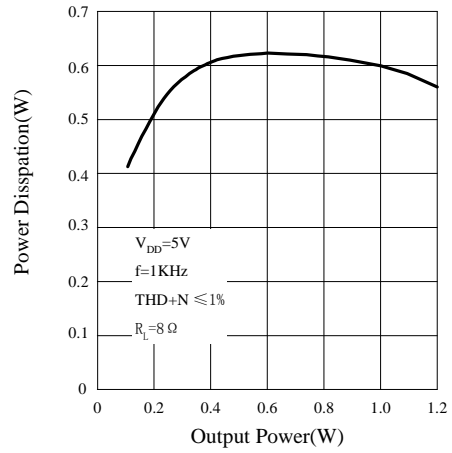

Power Dissipation vs Output Power

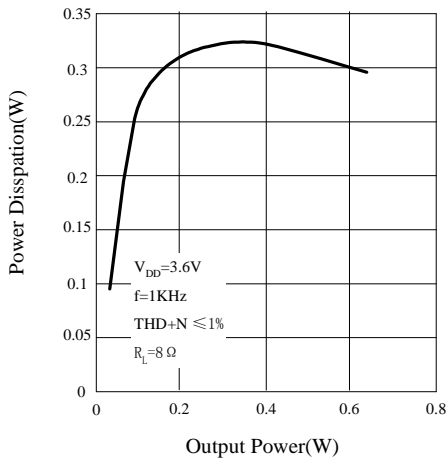

Power Derating Curve

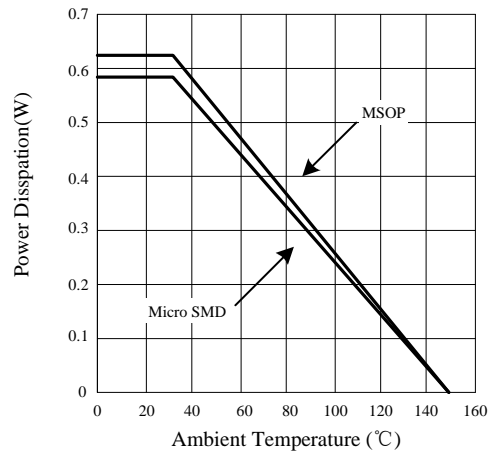

THD+N vs Frequency  
 $V_{DD}=5V, R_L=8\ \Omega, P_O=600mW$

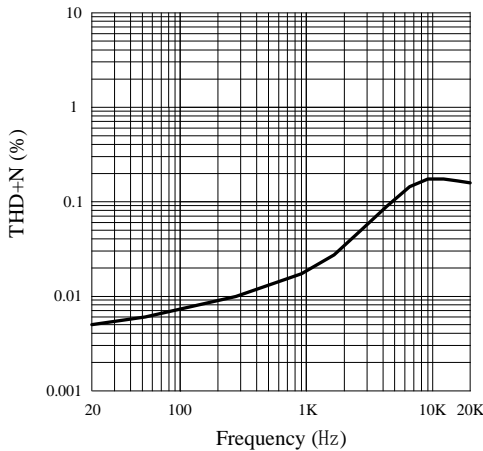

THD+N vs Frequency  
 $V_{DD}=3.6V, R_L=8\ \Omega, P_O=400mW$

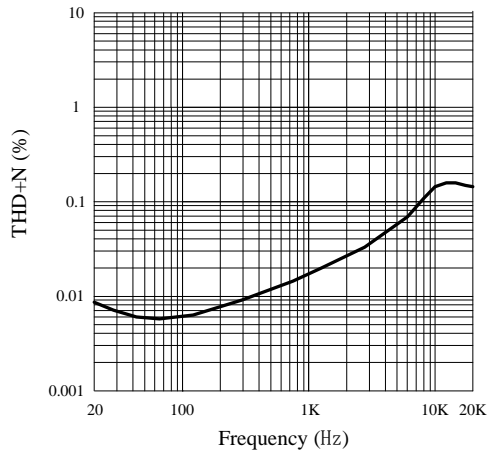

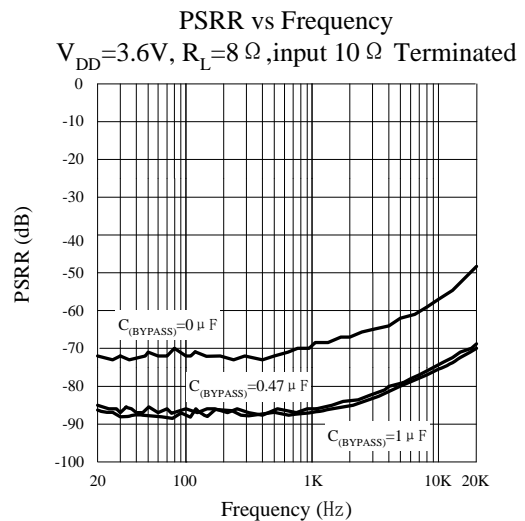
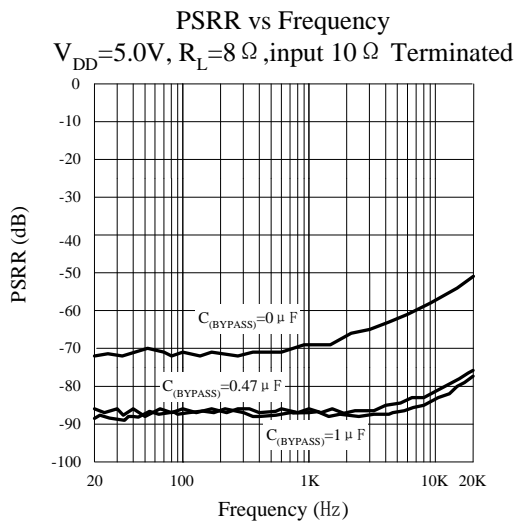
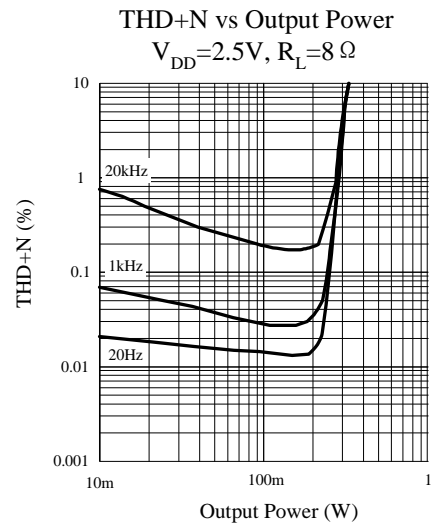
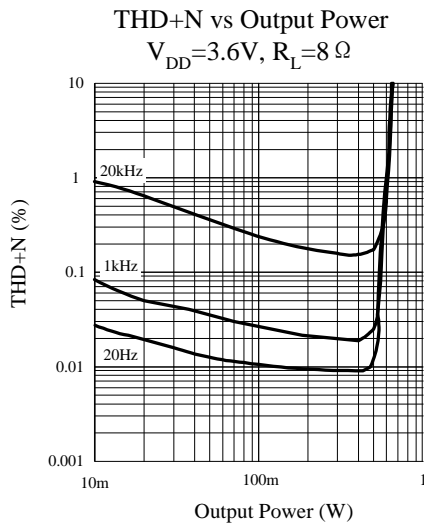
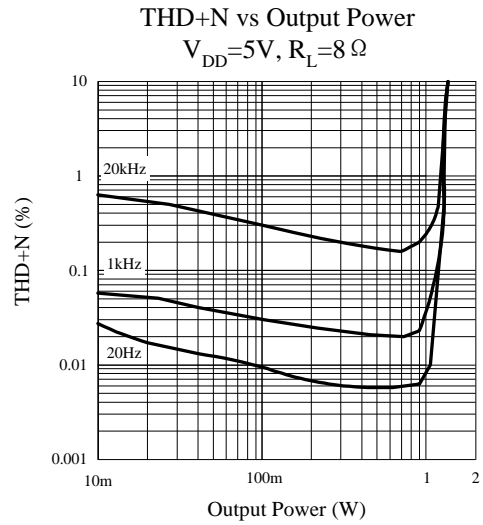
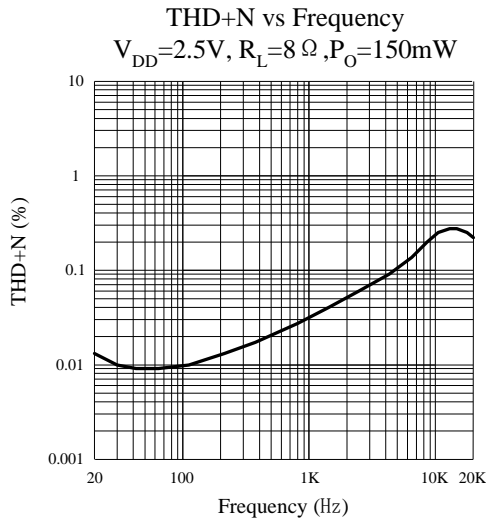

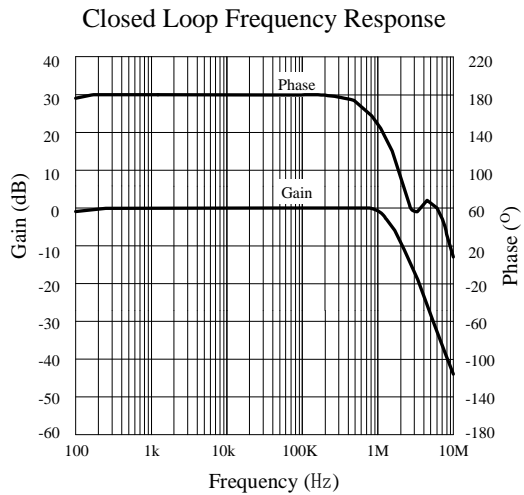
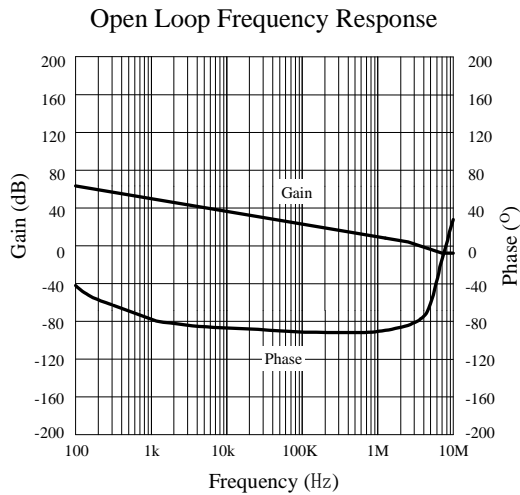
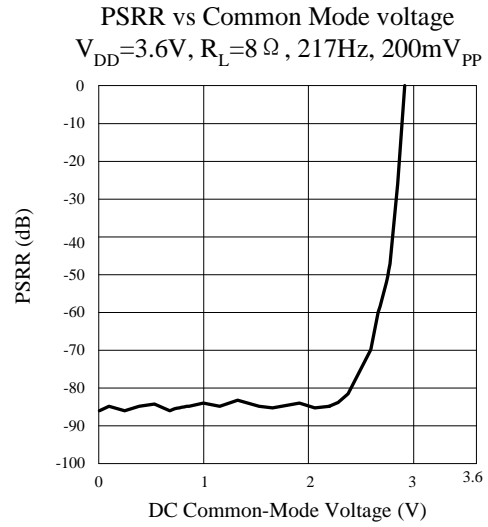
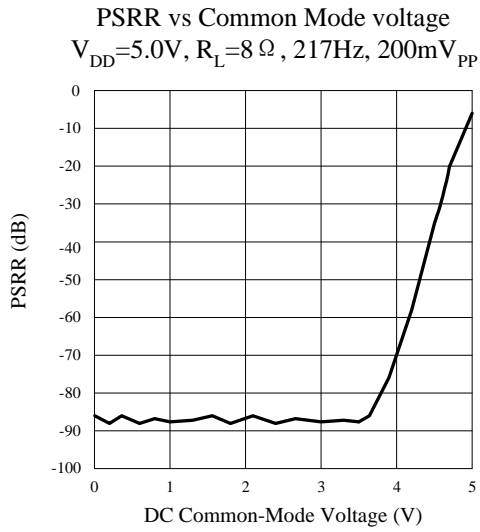



**Application**

From Figure 3 to Figure 5 show application schematics for differential and single-ended inputs.

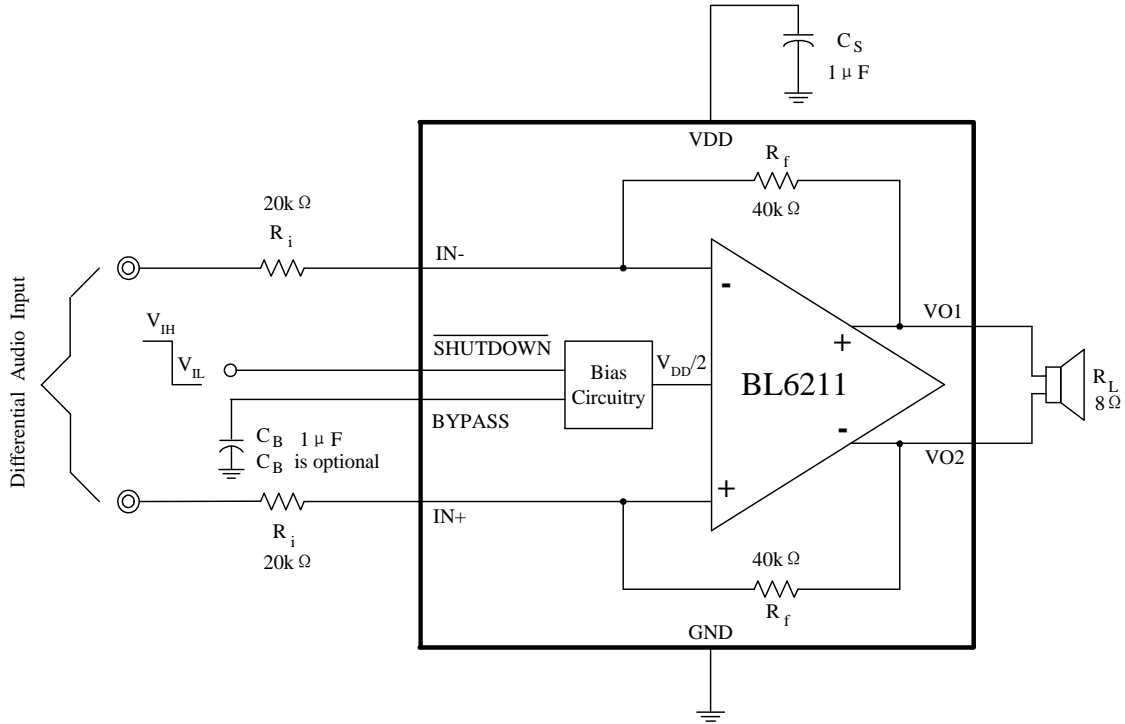

**Figure 2 Typical Differential Input Application**

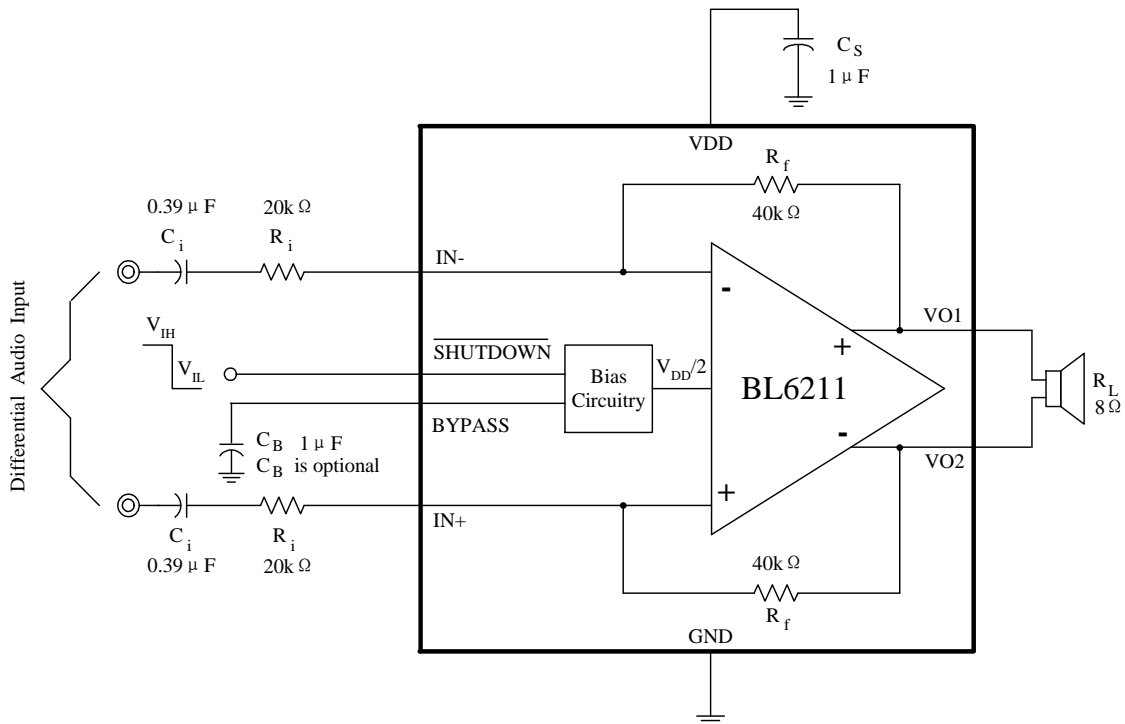

**Figure3 Differential Input Application With Input Capacitors**

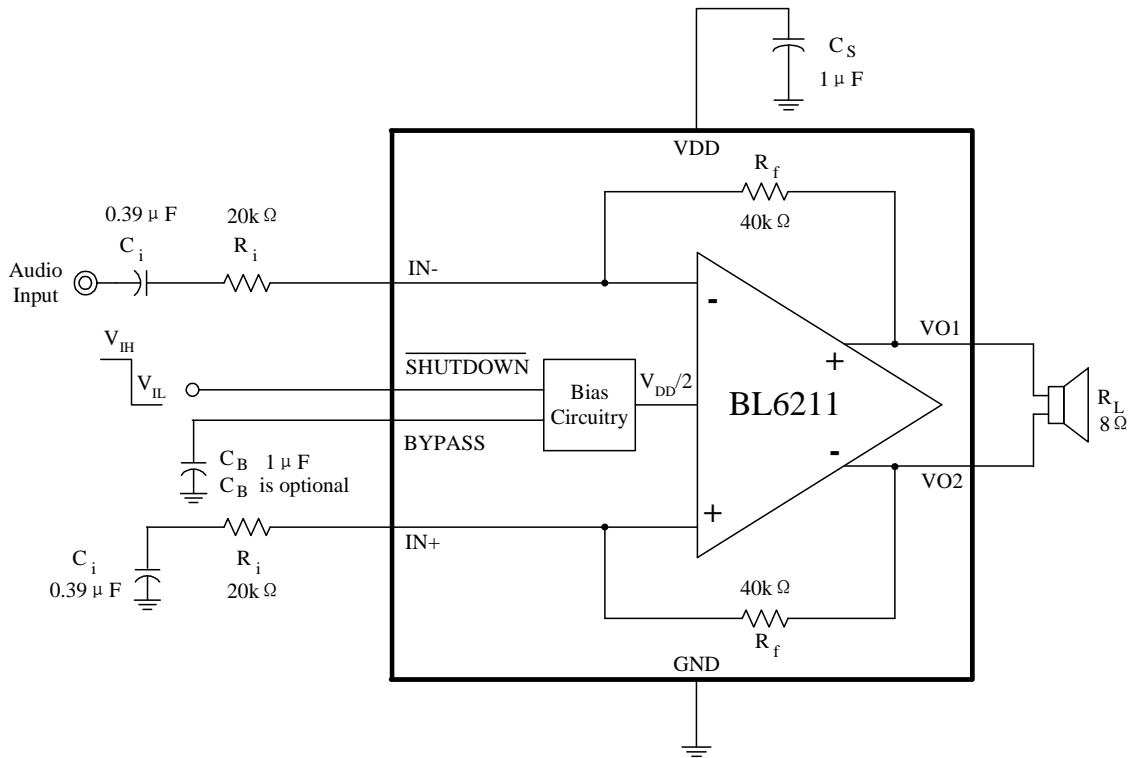

Figure4 Single-Ended Input Application