

*Phase leg
Series & parallel diodes
MOSFET Power Module*

$V_{DSS} = 500V$
 $R_{DSon} = 24m\Omega \text{ max @ } T_j = 25^\circ C$
 $I_D = 150A \text{ @ } T_c = 25^\circ C$

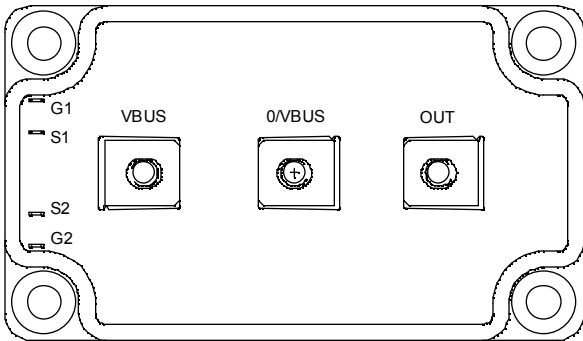
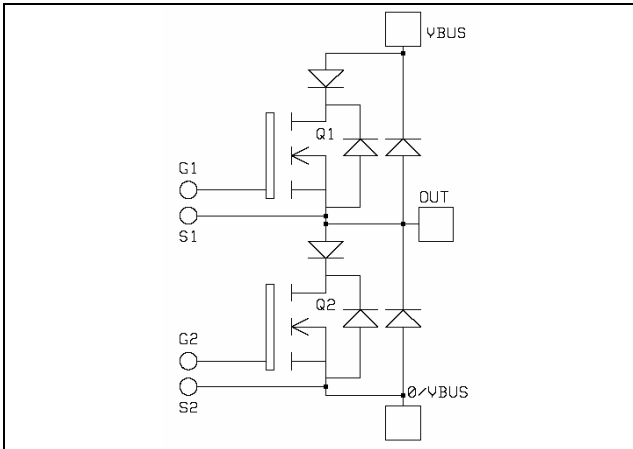

Application

- Motor control
- Switched Mode Power Supplies
- Uninterruptible Power Supplies

Features

- Power MOS 7[®] MOSFETs
 - Low R_{DSon}
 - Low input and Miller capacitance
 - Low gate charge
 - Fast intrinsic reverse diode
 - Avalanche energy rated
 - Very rugged
- Kelvin source for easy drive
- Very low stray inductance
 - Symmetrical design
 - M5 power connectors
- High level of integration

Benefits

- Outstanding performance at high frequency operation
- Direct mounting to heatsink (isolated package)
- Low junction to case thermal resistance
- Low profile

Absolute maximum ratings

Symbol	Parameter	Max ratings	Unit
V_{DSS}	Drain - Source Breakdown Voltage	500	V
I_D	Continuous Drain Current	$T_c = 25^\circ C$	150
		$T_c = 80^\circ C$	110
I_{DM}	Pulsed Drain current	600	A
V_{GS}	Gate - Source Voltage	± 30	V
R_{DSon}	Drain - Source ON Resistance	24	$m\Omega$
P_D	Maximum Power Dissipation	$T_c = 25^\circ C$	1250
I_{AR}	Avalanche current (repetitive and non repetitive)	24	A
E_{AR}	Repetitive Avalanche Energy	30	mJ
E_{AS}	Single Pulse Avalanche Energy	1300	

CAUTION: These Devices are sensitive to Electrostatic Discharge. Proper Handling Procedures Should Be Followed.

All ratings @ $T_j = 25^\circ\text{C}$ unless otherwise specified

Electrical Characteristics

Symbol	Characteristic	Test Conditions	Min	Typ	Max	Unit
BV_{DSS}	Drain - Source Breakdown Voltage	$V_{GS} = 0V, I_D = 1.5mA$	500			V
I_{DSS}	Zero Gate Voltage Drain Current	$V_{GS} = 0V, V_{DS} = 500V$			500	μA
		$V_{GS} = 0V, V_{DS} = 400V$			3	mA
$R_{DS(on)}$	Drain - Source on Resistance	$V_{GS} = 10V, I_D = 75A$			24	$m\Omega$
$V_{GS(th)}$	Gate Threshold Voltage	$V_{GS} = V_{DS}, I_D = 6mA$	3		5	V
I_{GSS}	Gate - Source Leakage Current	$V_{GS} = \pm 30V, V_{DS} = 0V$			± 500	nA

Dynamic Characteristics

Symbol	Characteristic	Test Conditions	Min	Typ	Max	Unit
C_{iss}	Input Capacitance	$V_{GS} = 0V$		19.6		nF
C_{oss}	Output Capacitance	$V_{DS} = 25V$		4.2		
C_{rss}	Reverse Transfer Capacitance	$f = 1MHz$		0.3		
Q_g	Total gate Charge	$V_{GS} = 10V$ $V_{Bus} = 250V$ $I_D = 150A$		434		nC
Q_{gs}	Gate - Source Charge			120		
Q_{gd}	Gate - Drain Charge			216		
$T_{d(on)}$	Turn-on Delay Time	Inductive switching @ 125°C $V_{GS} = 15V$ $V_{Bus} = 333V$ $I_D = 150A$ $R_G = 0.8\Omega$		10		ns
T_r	Rise Time			17		
$T_{d(off)}$	Turn-off Delay Time			50		
T_f	Fall Time			41		

Series diode ratings and characteristics

Symbol	Characteristic	Test Conditions	Min	Typ	Max	Unit
$I_{F(AV)}$	Maximum Average Forward Current	50% duty cycle $T_c = 85^\circ\text{C}$		120		A
V_F	Diode Forward Voltage	$I_F = 120A$		1.1	1.15	V
		$I_F = 240A$		1.4		
		$I_F = 120A$	$T_j = 125^\circ\text{C}$	0.9		
t_{rr}	Reverse Recovery Time	$I_F = 120A$ $V_R = 133V$ $di/dt = 400A/\mu s$	$T_j = 25^\circ\text{C}$	31		ns
			$T_j = 125^\circ\text{C}$	60		
Q_{rr}	Reverse Recovery Charge	$I_F = 120A$ $V_R = 133V$ $di/dt = 400A/\mu s$	$T_j = 25^\circ\text{C}$	120		nC
			$T_j = 125^\circ\text{C}$	500		

Parallel diode ratings and characteristics

Symbol	Characteristic	Test Conditions	Min	Typ	Max	Unit
$I_{F(AV)}$	Maximum Average Forward Current	50% duty cycle $T_c = 70^\circ\text{C}$		120		A
V_F	Diode Forward Voltage	$I_F = 120A$		1.6	1.8	V
		$I_F = 240A$		1.9		
		$I_F = 120A$	$T_j = 125^\circ\text{C}$	1.4		
t_{rr}	Reverse Recovery Time	$I_F = 120A$ $V_R = 400V$ $di/dt = 400A/\mu s$	$T_j = 25^\circ\text{C}$	130		ns
			$T_j = 125^\circ\text{C}$	170		
Q_{rr}	Reverse Recovery Charge	$I_F = 120A$ $V_R = 400V$ $di/dt = 400A/\mu s$	$T_j = 25^\circ\text{C}$	440		nC
			$T_j = 125^\circ\text{C}$	1840		

Thermal and package characteristics

Symbol Characteristic Min Typ Max Unit

R _{thJC}	Junction to Case	Transistor			0.10	°C/W
		Diode serie			0.46	
		Diode parallel			0.46	
V _{ISOL}	RMS Isolation Voltage, any terminal to case t=1 min, I _{isol} <1mA, 50/60Hz		2500			V
T _J	Operating junction temperature range		-40		150	°C
T _{STG}	Storage Temperature Range		-40		125	
T _C	Operating Case Temperature		-40		100	
Torque	Mounting torque	To heatsink	M6	3	5	N.m
		For terminals	M5	2	3.5	
Wt	Package Weight				280	g

Package outline

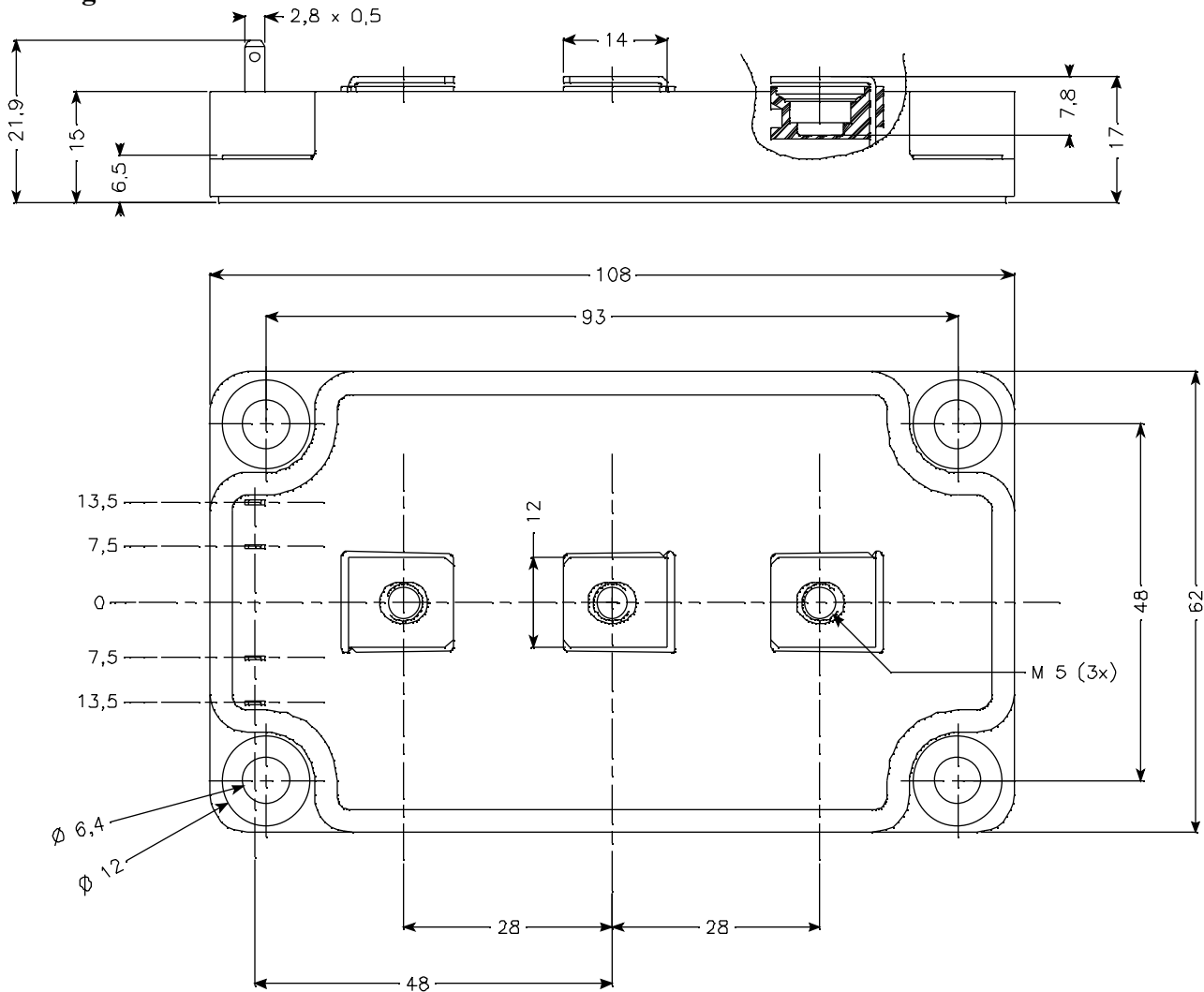

Typical Performance Curve

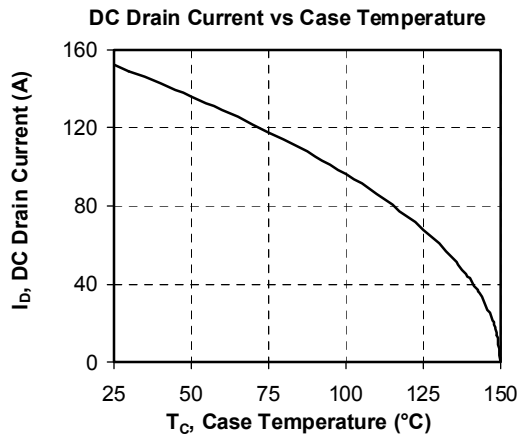
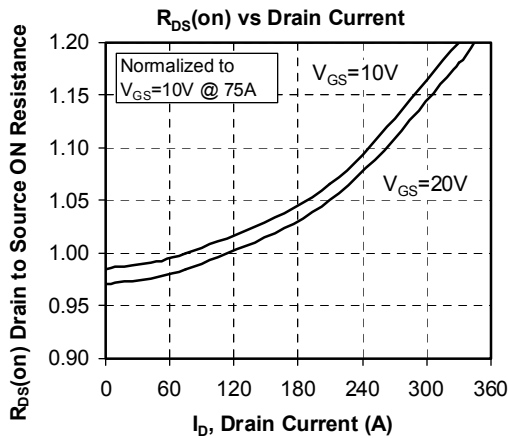
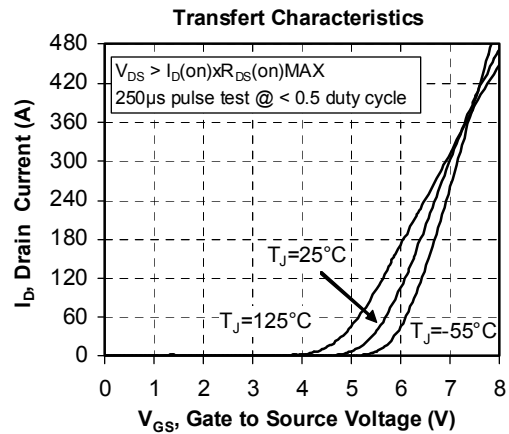
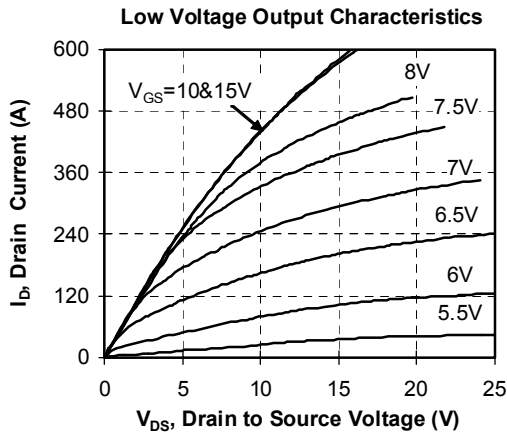
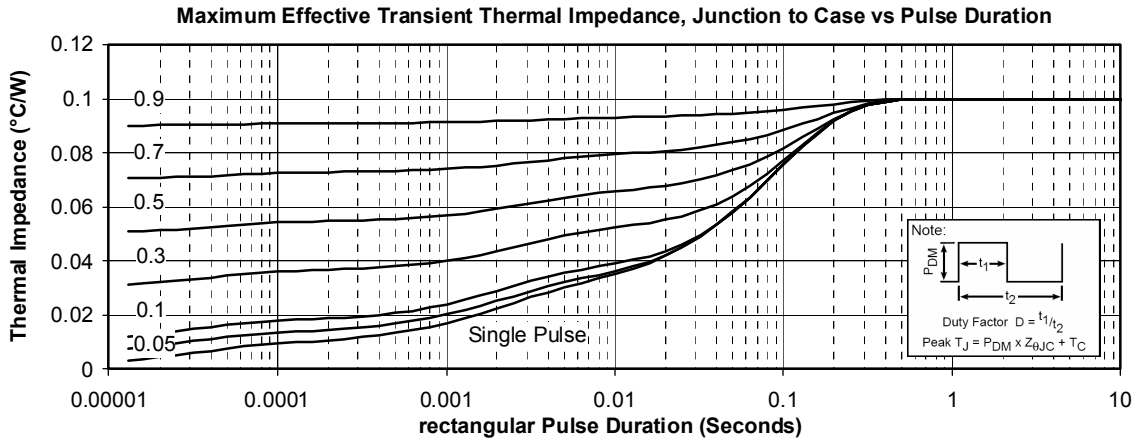

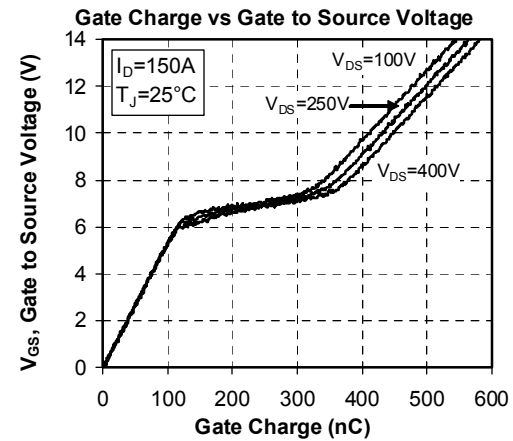
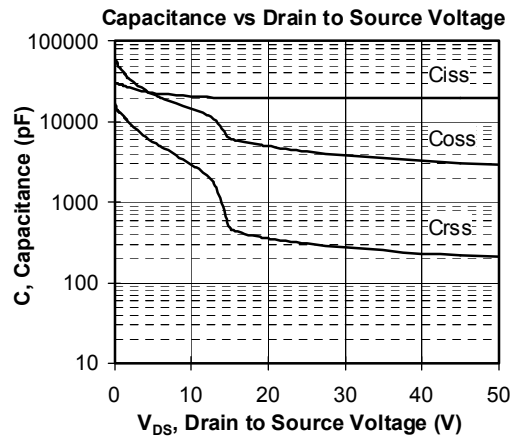
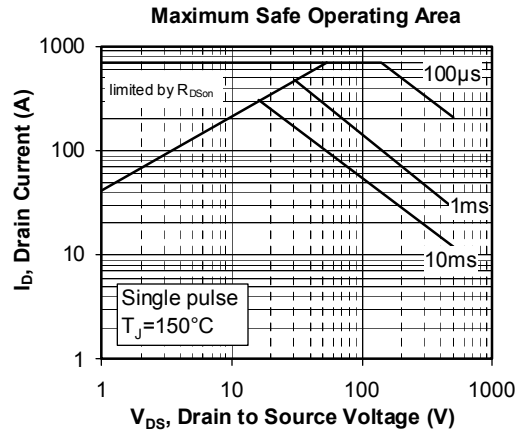
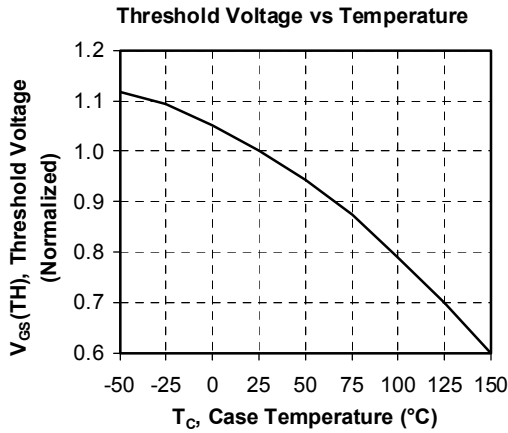
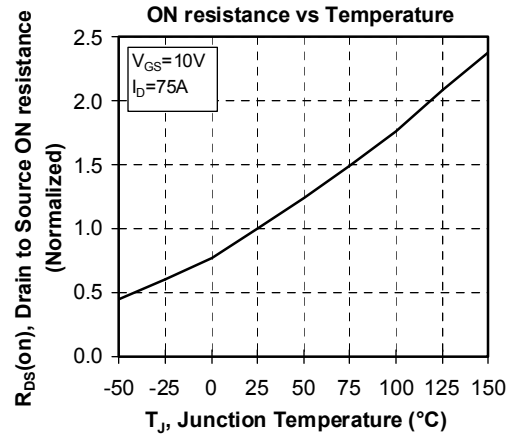
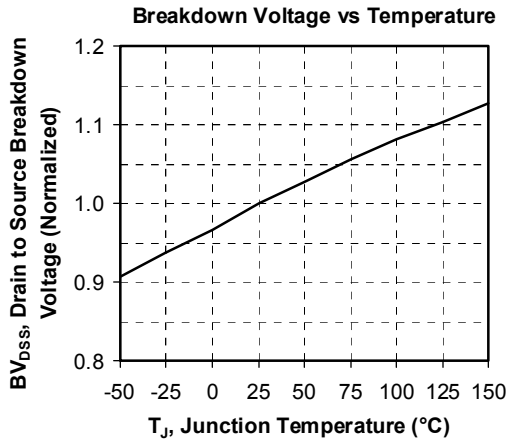

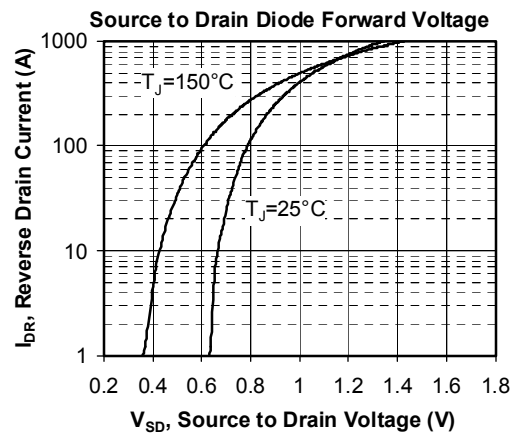
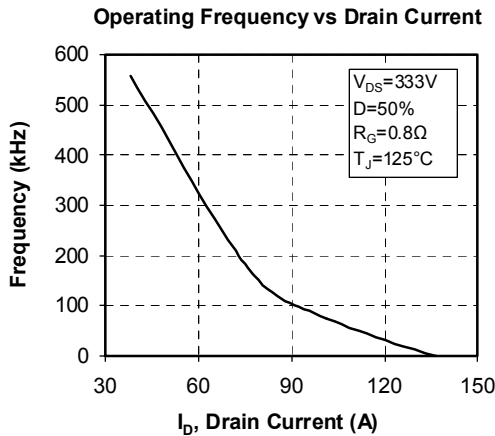
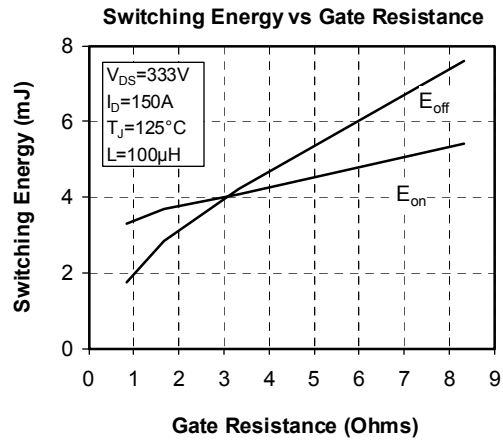
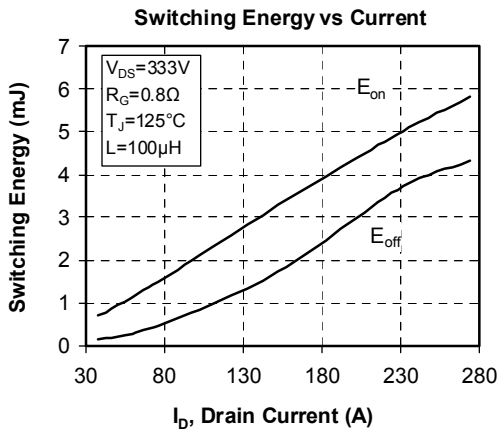
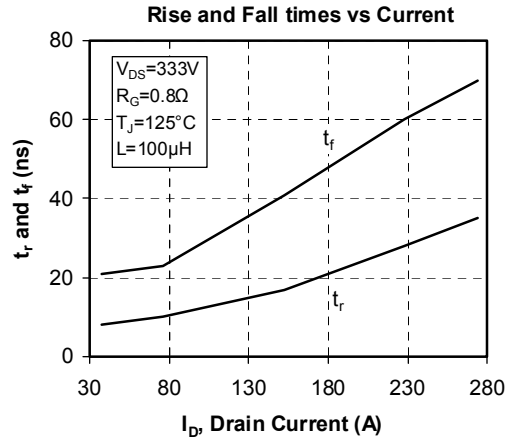
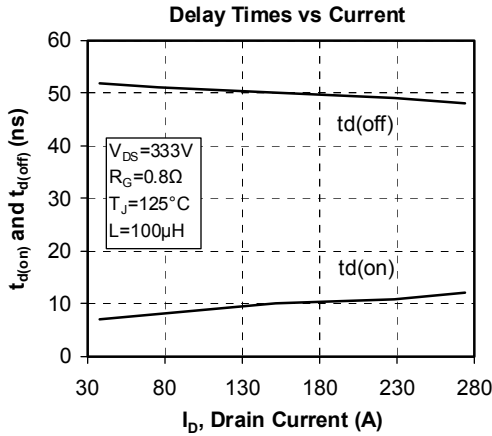

APT reserves the right to change, without notice, the specifications and information contained herein

APT's products are covered by one or more of U.S. patents 4,895,810 5,045,903 5,089,434 5,182,234 5,019,522 5,262,336 6,503,786 5,256,583 4,748,103 5,283,202 5,231,474 5,434,095 5,528,058 and foreign patents. U.S. and Foreign patents pending. All Rights Reserved.