

### Features

- High speed switching
- Low on-resistance
- No secondary breakdown
- Low driving power
- Avalanche-proof

### Applications

- Switching regulators
- UPS (Uninterruptible Power Supply)
- DC-DC converters

### Maximum ratings and characteristic Absolute maximum ratings

(Tc=25°C unless otherwise specified)

Item	Symbol	Ratings	Unit
Drain-source voltage	V <sub>DS</sub>	600	V
Continuous drain current	I <sub>D</sub>	±6	A
Pulsed drain current	I <sub>D(puls)</sub>	±24	A
Gate-source voltage	V <sub>GS</sub>	±30	V
Repetitive or non-repetitive	I <sub>AR</sub> *2	6	A
Maximum Avalanche Energy	E <sub>AS</sub> *1	193	mJ
Maximum Drain-Source dV/dt	dV <sub>DS</sub> /dt *4	20	kV/μs
Peak Diode Recovery dV/dt	dV/dt *3	5	kV/μs
Max. power dissipation	P <sub>D</sub>	T <sub>a</sub> =25°C	1.92
		T <sub>c</sub> =25°C	62
Operating and storage temperature range	T <sub>ch</sub>	+150	°C
	T <sub>stg</sub>	-55 to +150	°C

\*1 L=9.83mH, V<sub>CC</sub>=60V \*2 T<sub>ch</sub>≤150°C \*3 I<sub>F</sub>≤-I<sub>D</sub>, -di/dt=50A/μs, V<sub>CC</sub>≤BV<sub>bss</sub>, T<sub>ch</sub>≤150°C  
\*4 V<sub>DS</sub>≤600V

### Electrical characteristics (Tc =25°C unless otherwise specified)

Item	Symbol	Test Conditions	Min.	Typ.	Max.	Units
Drain-source breakdown voltage	V <sub>(BR)DSS</sub>	I <sub>D</sub> =250μA V <sub>GS</sub> =0V	600			V
Gate threshold voltage	V <sub>GS(th)</sub>	I <sub>D</sub> =250μA V <sub>DS</sub> =V <sub>GS</sub>	3.0		5.0	V
Zero gate voltage drain current	I <sub>DSS</sub>	V <sub>DS</sub> =600V V <sub>GS</sub> =0V			25	μA
		V <sub>DS</sub> =480V V <sub>GS</sub> =0V			250	
Gate-source leakage current	I <sub>GSS</sub>	V <sub>GS</sub> =±30V V <sub>DS</sub> =0V		10	100	nA
Drain-source on-state resistance	R <sub>DS(on)</sub>	I <sub>D</sub> =3A V <sub>GS</sub> =10V		0.93	1.20	Ω
Forward transconductance	g <sub>fs</sub>	I <sub>D</sub> =3A V <sub>DS</sub> =25V	3	6		S
Input capacitance	C <sub>iss</sub>	V <sub>DS</sub> =25V		750	1130	pF
Output capacitance	C <sub>oss</sub>	V <sub>GS</sub> =0V		100	150	
Reverse transfer capacitance	C <sub>rss</sub>	f=1MHz		4.0	6.0	
Turn-on time t <sub>on</sub>	td(on)	V <sub>CC</sub> =300V I <sub>D</sub> =3A		14	21	ns
	t <sub>r</sub>	V <sub>GS</sub> =10V		9	14	
Turn-off time t <sub>off</sub>	td(off)	R <sub>GS</sub> =10 Ω		24	36	
	t <sub>f</sub>			7	10.5	
Total Gate Charge	Q <sub>G</sub>	V <sub>CC</sub> =300V		20	30	nC
Gate-Source Charge	Q <sub>GS</sub>	I <sub>D</sub> =6A		8.5	13	
Gate-Drain Charge	Q <sub>GD</sub>	V <sub>GS</sub> =10V		5.5	8.5	
Avalanche capability	I <sub>AV</sub>	L=9.83mH T <sub>ch</sub> =25°C	6			A
Diode forward on-voltage	V <sub>SD</sub>	I <sub>F</sub> =6A V <sub>GS</sub> =0V T <sub>ch</sub> =25°C		1.00	1.50	V
Reverse recovery time	t <sub>rr</sub>	I <sub>F</sub> =6A V <sub>GS</sub> =0V		0.7		μs
Reverse recovery charge	Q <sub>rr</sub>	-di/dt=100A/μs T <sub>ch</sub> =25°C		3.5		μC

### Thermal characteristics

Item	Symbol	Test Conditions	Min.	Typ.	Max.	Units
Thermal resistance	R <sub>th(ch-c)</sub>	channel to case			1.92	°C/W
	R <sub>th(ch-a)</sub>	channel to ambient			62.0	°C/W

### Outline Drawings

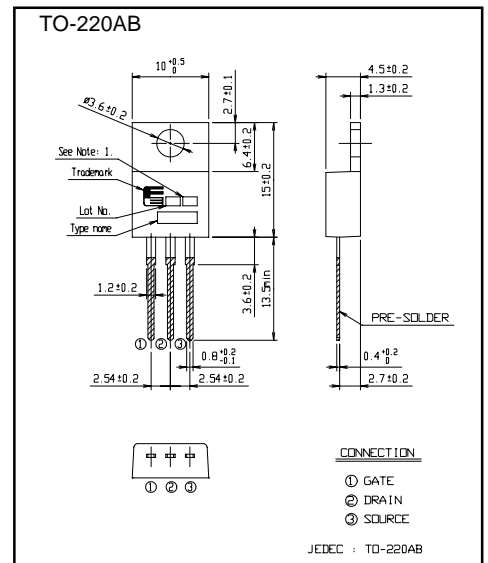

### Equivalent circuit schematic

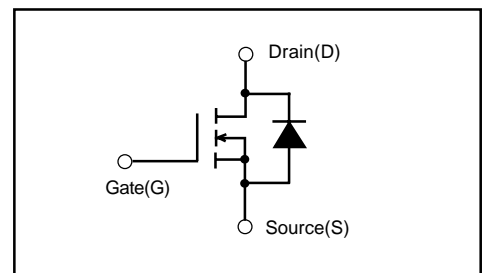

Characteristics

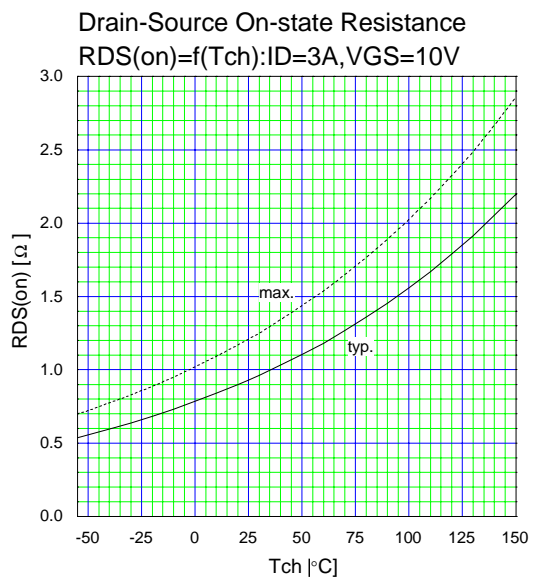
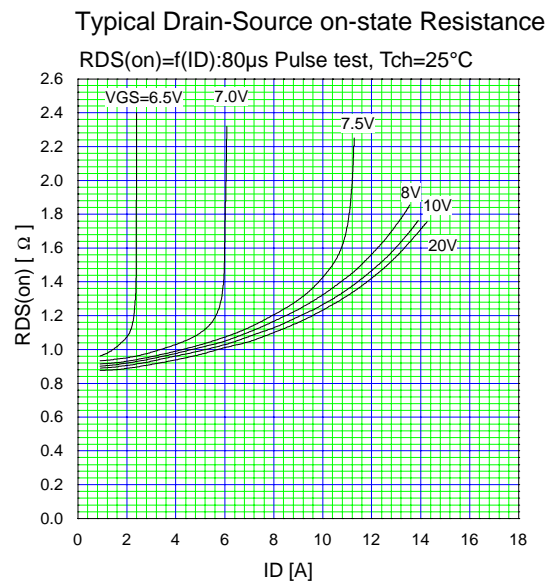
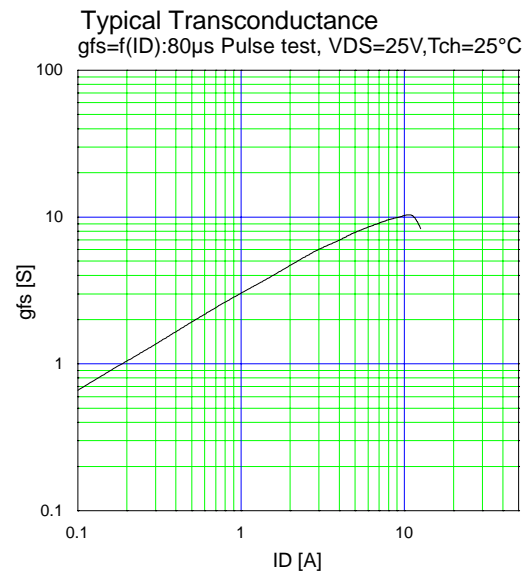
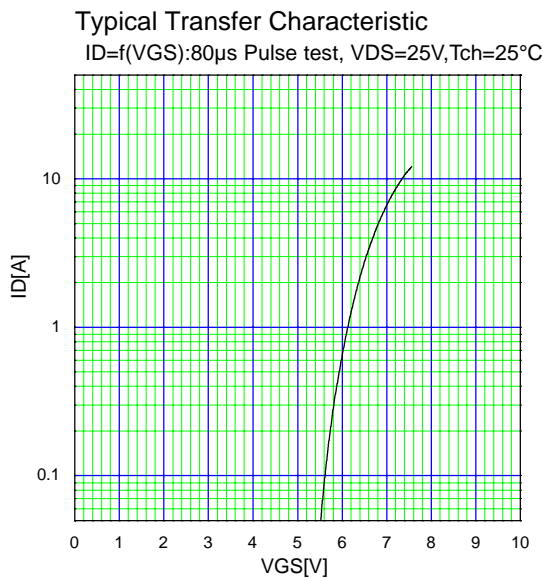
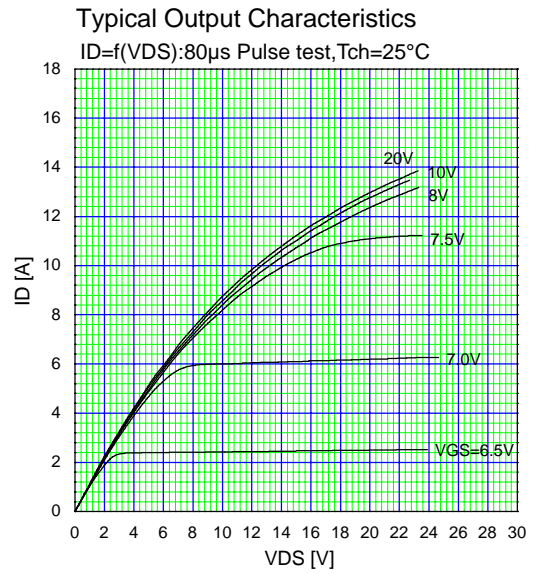
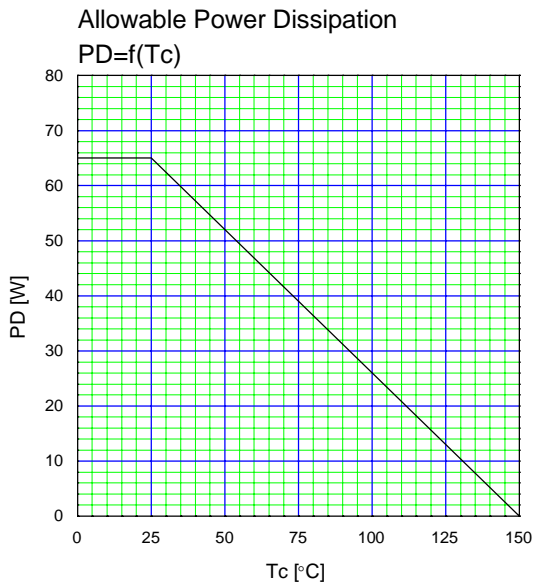

Gate Threshold Voltage vs. T<sub>ch</sub>

V<sub>GS(th)</sub>=f(T<sub>ch</sub>):V<sub>DS</sub>=V<sub>GS</sub>,I<sub>D</sub>=250μA

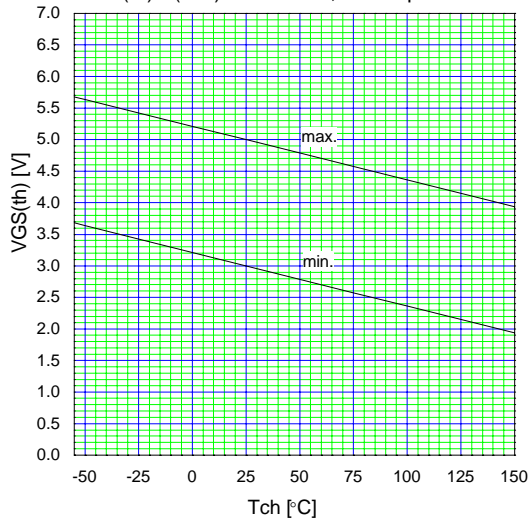

Typical Gate Charge Characteristics

V<sub>GS</sub>=f(Q<sub>g</sub>):I<sub>D</sub>=3A, T<sub>ch</sub>=25°C

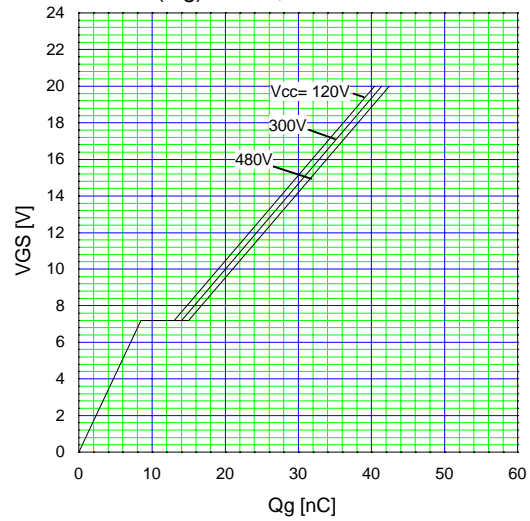

Typical Capacitance

C=f(V<sub>DS</sub>):V<sub>GS</sub>=0V,f=1MHz

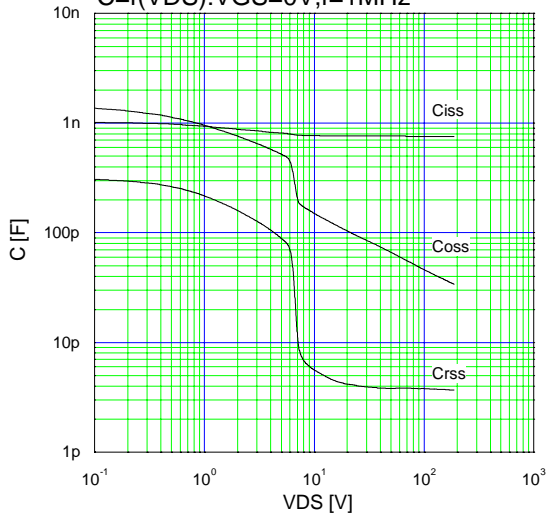

Typical Forward Characteristics of Reverse Diode

I<sub>F</sub>=f(V<sub>SD</sub>):80μs Pulse test,T<sub>ch</sub>=25°C

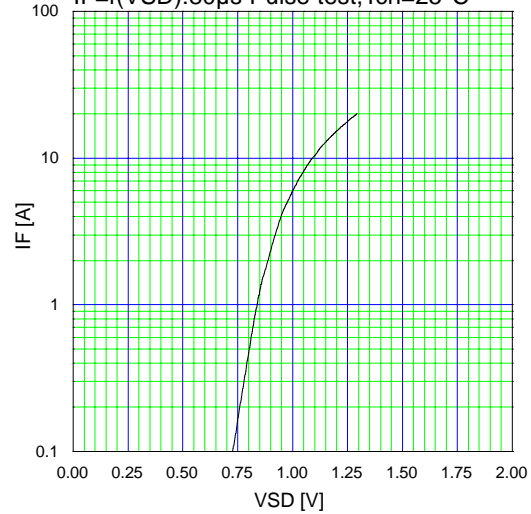

Typical Switching Characteristics vs. I<sub>D</sub>

t=f(I<sub>D</sub>):V<sub>cc</sub>=300V, V<sub>GS</sub>=10V, R<sub>G</sub>=10Ω

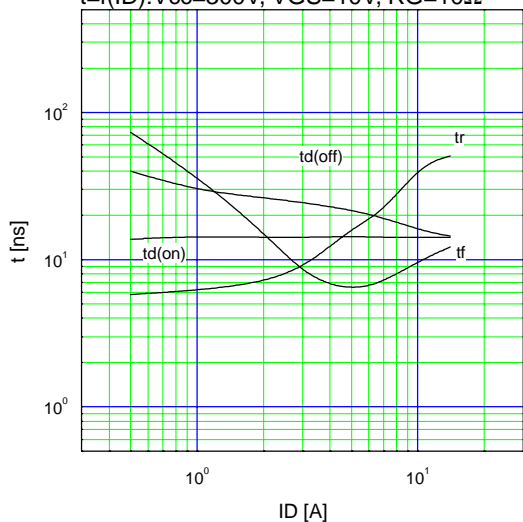

Maximum Avalanche Energy vs. starting T<sub>ch</sub>

E(AV)=f(starting T<sub>ch</sub>):V<sub>cc</sub>=60V,I(AV)<=6A

