

# IR21303C

## 3-PHASE BRIDGE DRIVER

### Features

- Floating channel designed for bootstrap operation  
 Fully operational to +600V  
 Tolerant to negative transient voltage  
 dV/dt immune
- Gate drive supply range from 11.1 to 20V
- Undervoltage lockout for all channels
- Over-current shutdown turns off all six drivers
- Independent half-bridge drivers
- Matched propagation delay for all channels
- 2.5V logic compatible
- Outputs out of phase with inputs
- Cross-conduction prevention logic

### Product Summary

<b>V<sub>OFFSET</sub></b>	<b>600V max.</b>
<b>I<sub>O+/-</sub></b>	<b>200 mA / 420 mA</b>
<b>V<sub>OUT</sub></b>	<b>11.1 - 20V</b>
<b>t<sub>on/off</sub> (typ.)</b>	<b>675 &amp; 425 ns</b>
<b>Deadtime (typ.)</b>	<b>600 ns</b>

### Description

The IR21303C is a high voltage, high speed power MOSFET and IGBT driver with three independent high and low side referenced output channels. Proprietary HVIC technology enables ruggedized monolithic construction. Logic inputs are compatible with CMOS or LSTTL outputs, down to 2.5V logic. A ground-referenced operational amplifier provides analog feedback of bridge current via an external current sense resistor. A current trip function which terminates all six outputs is also derived from this resistor. An open drain  $\overline{\text{FAULT}}$  signal indicates if an over-current or undervoltage shutdown has occurred. The output drivers feature a high pulse current buffer stage designed for minimum driver cross-conduction. Propagation delays are matched to simplify use at high frequencies. The floating channels can be used to drive N-channel power MOSFETs or IGBTs in the high side configuration which operate up to 600 volts.

### Typical Connection

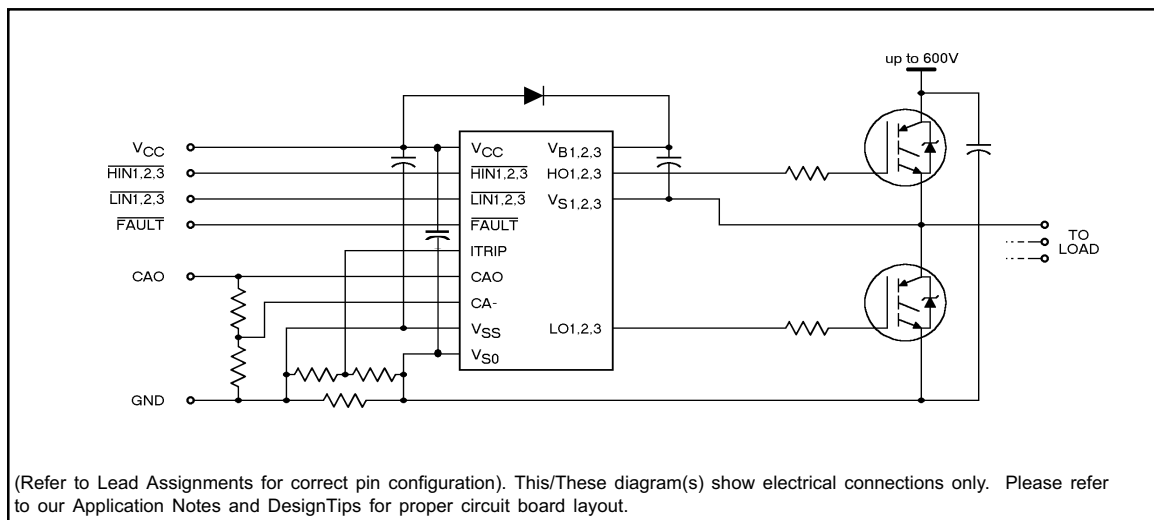

## Absolute Maximum Ratings

Absolute Maximum Ratings indicate sustained limits beyond which damage to the device may occur. All voltage parameters are absolute voltages referenced to  $V_{S0}$ . The Thermal Resistance and Power Dissipation ratings are measured under board mounted and still air conditions. Additional information is shown in Figures 50 through 53.

Symbol	Definition	Min.	Max.	Units	
$V_{B1,2,3}$	High Side Floating Supply Voltage	-0.3	625	V	
$V_{S1,2,3}$	High Side Floating Offset Voltage	$V_{B1,2,3} - 25$	$V_{B1,2,3} + 0.3$		
$V_{HO1,2,3}$	High Side Floating Output Voltage	$V_{S1,2,3} - 0.3$	$V_{B1,2,3} + 0.3$		
$V_{CC}$	Low Side and Logic Fixed Supply Voltage	-0.3	25		
$V_{SS}$	Logic Ground	$V_{CC} - 25$	$V_{CC} + 0.3$		
$V_{LO1,2,3}$	Low Side Output Voltage	-0.3	$V_{CC} + 0.3$		
$V_{IN}$	Logic Input Voltage (HIN1,2,3, LIN1,2,3 & ITRIP)	$V_{SS} - 0.3$	( $V_{SS} + 15$ ) or ( $V_{CC} + 0.3$ ) whichever is lower		
$V_{FLT}$	FAULT Output Voltage	$V_{SS} - 0.3$	$V_{CC} + 0.3$		
$V_{CAO}$	Operational Amplifier Output Voltage	$V_{SS} - 0.3$	$V_{CC} + 0.3$		
$V_{CA-}$	Operational Amplifier Inverting Input Voltage	$V_{SS} - 0.3$	$V_{CC} + 0.3$		
d $V_S$ /dt	Allowable Offset Supply Voltage Transient	—	50		V/ns
$T_J$	Junction Temperature	—	150		°C

## Recommended Operating Conditions

The Input/Output logic timing diagram is shown in Figure 1. For proper operation the device should be used within the recommended conditions. All voltage parameters are absolute voltages referenced to  $V_{S0}$ . The  $V_S$  offset rating is tested with all supplies biased at 15V differential. Typical ratings at other bias conditions are shown in Figure 54.

Symbol	Definition	Min.	Max.	Units
$V_{B1,2,3}$	High Side Floating Supply Voltage	$V_{S1,2,3} + 13.3$	$V_{S1,2,3} + 20$	V
$V_{S1,2,3}$	High Side Floating Offset Voltage	Note 1	600	
$V_{HO1,2,3}$	High Side Floating Output Voltage	$V_{S1,2,3}$	$V_{B1,2,3}$	
$V_{CC}$	Low Side and Logic Fixed Supply Voltage	13.3	20	
$V_{SS}$	Logic Ground	-5	5	
$V_{LO1,2,3}$	Low Side Output Voltage	0	$V_{CC}$	
$V_{IN}$	Logic Input Voltage (HIN1,2,3, LIN1,2,3 & ITRIP)	$V_{SS}$	$V_{SS} + 5$	
$V_{FLT}$	FAULT Output Voltage	$V_{SS}$	$V_{CC}$	
$V_{CAO}$	Operational Amplifier Output Voltage	$V_{SS}$	$V_{SS} + 5$	
$V_{CA-}$	Operational Amplifier Inverting Input Voltage	$V_{SS}$	$V_{SS} + 5$	
$T_A$	Ambient Temperature	-40	125	°C

Note 1: Logic operational for  $V_S$  of ( $V_{S0} - 5V$ ) to ( $V_{S0} + 600V$ ). Logic state held for  $V_S$  of ( $V_{S0} - 5V$ ) to ( $V_{S0} - V_{BS}$ ). (Please refer to the Design Tip DT97-3 for more details).

Note 2: All input pins, CA- and CAO pins are internally clamped with a 5.2V zener diode.

## Dynamic Electrical Characteristics

$V_{BIAS}$  ( $V_{CC}$ ,  $V_{BS1,2,3}$ ) = 15V,  $V_{S0,1,2,3}$  =  $V_{SS}$ ,  $C_L$  = 1000 pF and  $T_A$  = 25°C unless otherwise specified. The dynamic electrical characteristics are defined in Figures 3 through 5.

Symbol	Definition	Figure	Min.	Typ.	Max.	Units	Test Conditions
$t_{on}$	Turn-On Propagation Delay	11	450	675	850	ns	$V_{IN} = 0$ & 5V $V_{S1,2,3} = 0$ to 600V
$t_{off}$	Turn-Off Propagation Delay	12	300	425	550		
$t_r$	Turn-On Rise Time	13	—	80	125		
$t_f$	Turn-Off Fall Time	14	—	35	55		
$t_{itrip}$	ITRIP to Output Shutdown Prop. Delay	15	400	660	920		
$t_{bl}$	ITRIP Blanking Time	—	—	400	—		
$t_{flt}$	ITRIP to $\overline{FAULT}$ Indication Delay	16	335	590	845		
$t_{flt,in}$	Input Filter Time (All Six Inputs)	—	—	310	—	ns	$V_{IN}, V_{ITRIP} = 0$ & 5V $V_{IN} = 0$ & 5V
$t_{flt,clr}$	LIN1,2,3 & HIN1,2,3 to $\overline{FAULT}$ Clear Time	17	6.0	9.0	12.0		
DT	Deadtime	—	300	600	900		
SR+	Operational Amplifier Slew Rate (+)	18	4.4	6.2	—	V/ $\mu$ s	$V_{IN}, V_{ITRIP} = 0$ & 5V $V_{IN} = 0$ & 5V
SR-	Operational Amplifier Slew Rate (-)	19	2.4	3.2	—		

NOTE: For high side PWM, HIN pulse width must be  $\geq 1.5\mu$ sec

## Static Electrical Characteristics

$V_{BIAS}$  ( $V_{CC}$ ,  $V_{BS1,2,3}$ ) = 15V,  $V_{S0,1,2,3}$  =  $V_{SS}$  and  $T_A$  = 25°C unless otherwise specified. The  $V_{IN}$ ,  $V_{TH}$  and  $I_{IN}$  parameters are referenced to  $V_{SS}$  and are applicable to all six logic input leads:  $\overline{HIN1,2,3}$  &  $\overline{LIN1,2,3}$ . The  $V_O$  and  $I_O$  parameters are referenced to  $V_{S0,1,2,3}$  and are applicable to the respective output leads: HO1,2,3 or LO1,2,3.

Symbol	Definition	Figure	Min.	Typ.	Max.	Units	Test Conditions
$V_{IH}$	Logic "0" Input Voltage (OUT = LO)	20	2.2	—	—	V	
$V_{IL}$	Logic "1" Input Voltage (OUT = HI)	21	—	—	0.8		
$V_{IT,TH+}$	ITRIP Input Positive Going Threshold	—	436.8	480	529.2	mV	$V_{IN} = 0V, I_O = 0A$ $V_{IN} = 5V, I_O = 0A$
$V_{OH}$	High Level Output Voltage, $V_{BIAS} - V_O$	22	—	—	100		
$V_{OL}$	Low Level Output Voltage, $V_O$	23	—	—	100	$\mu$ A	$V_B = V_S = 600V$ $V_{IN} = 0V$ or 5V
$I_{LK}$	Offset Supply Leakage Current	24	—	—	50		
$I_{QBS}$	Quiescent $V_{BS}$ Supply Current	25	—	15	30	mA	$V_{IN} = 0V$ or 5V
$I_{QCC}$	Quiescent $V_{CC}$ Supply Current	26	—	3.0	4.0		
$I_{IN+}$	Logic "1" Input Bias Current (OUT = HI)	27	—	450	650	$\mu$ A	$V_{IN} = 0V$ $V_{IN} = 5V$
$I_{IN-}$	Logic "0" Input Bias Current (OUT = LO)	28	—	225	400		
$I_{ITRIP+}$	"High" ITRIP Bias Current	29	—	75	150	nA	ITRIP = 5V ITRIP = 0V
$I_{ITRIP-}$	"Low" ITRIP Bias Current	30	—	—	100		
$V_{BSUV+}$	$V_{BS}$ Supply Undervoltage Positive Going Threshold	—	10.8	12	13.2	V	
$V_{BSUV-}$	$V_{BS}$ Supply Undervoltage Negative Going Threshold	—	9	10	11		
$V_{CCUV+}$	$V_{CC}$ Supply Undervoltage Positive Going Threshold	—	10.8	12	13.2		
$V_{CCUV-}$	$V_{CC}$ Supply Undervoltage Negative Going Threshold	—	9.0	10	11		
$R_{on,FLT}$	$\overline{FAULT}$ Low On-Resistance	31	—	55	75		

## Static Electrical Characteristics -- Continued

$V_{BIAS}$  ( $V_{CC}$ ,  $V_{BS1,2,3}$ ) = 15V,  $V_{S0,1,2,3}$  =  $V_{SS}$  and  $T_A$  = 25°C unless otherwise specified. The  $V_{IN}$ ,  $V_{TH}$  and  $I_{IN}$  parameters are referenced to  $V_{SS}$  and are applicable to all six logic input leads:  $\overline{HIN1,2,3}$  &  $\overline{LIN1,2,3}$ . The  $V_O$  and  $I_O$  parameters are referenced to  $V_{S0,1,2,3}$  and are applicable to the respective output leads: HO1,2,3 or LO1,2,3.

Symbol	Definition	Figure	Min.	Typ.	Max.	Units	Test Conditions
$I_{O+}$	Output High Short Circuit Pulsed Current	32	200	250	—	mA	$V_O = 0V$ , $V_{IN} = 0V$ $PW \leq 10 \mu s$
$I_{O-}$	Output Low Short Circuit Pulsed Current	33	420	500	—		$V_O = 15V$ , $V_{IN} = 5V$ $PW \leq 10 \mu s$
$V_{OS}$	Operational Amplifier Input Offset Voltage	—	-14	—	14	mV	$V_{S0} = V_{CA-} = 0.2V$
$I_{CA-}$	CA- Input Bias Current	34	—	—	4.0	nA	$V_{CA-} = 2.5V$
CMRR	Op. Amp. Common Mode Rejection Ratio	35	60	80	—	dB	$V_{S0} = V_{CA-} = 0.1V$ & $5V$
PSRR	Op. Amp. Power Supply Rejection Ratio	36	55	75	—		$V_{S0} = V_{CA-} = 0.2V$ $V_{CC} = 14V$ & $20V$
$V_{OH,AMP}$	Op. Amp. High Level Output Voltage	37	5.0	5.2	5.4	V	$V_{CA-} = 0V$ , $V_{S0} = 1V$
$V_{OL,AMP}$	Op. Amp. Low Level Output Voltage	38	—	—	20	mV	$V_{CA-} = 1V$ , $V_{S0} = 0V$
$I_{SRC,AMP}$	Op. Amp. Output Source Current	39	2.3	4.0	—	mA	$V_{CA-} = 0V$ , $V_{S0} = 1V$ $V_{CAO} = 4V$
$I_{SINK,AMP}$	Op. Amp. Output Sink Current	40	1.0	2.1	—		$V_{CA-} = 1V$ , $V_{S0} = 0V$ $V_{CAO} = 2V$
$I_{O+,AMP}$	Operational Amplifier Output High Short Circuit Current	41	—	4.5	6.5		$V_{CA-} = 0V$ , $V_{S0} = 5V$ $V_{CAO} = 0V$
$I_{O-,AMP}$	Operational Amplifier Output Low Short Circuit Current	42	—	3.2	5.2		$V_{CA-} = 5V$ , $V_{S0} = 0V$ $V_{CAO} = 5V$

## Lead Definitions

Symbol	Description
$\overline{HIN1,2,3}$	Logic inputs for high side gate driver outputs (HO1,2,3), out of phase
$\overline{LIN1,2,3}$	Logic inputs for low side gate driver output (LO1,2,3), out of phase
FAULT	Indicates over-current or undervoltage lockout (low side) has occurred, negative logic
$V_{CC}$	Low side and logic fixed supply
ITRIP	Input for over-current shutdown
CAO	Output of current amplifier
CA-	Negative input of current amplifier
$V_{SS}$	Logic ground
$V_{B1,2,3}$	High side floating supplies
HO1,2,3	High side gate drive outputs
$V_{S1,2,3}$	High side floating supply returns
LO1,2,3	Low side gate drive outputs
$V_{S0}$	Low side return and positive input of current amplifier

**Pad Assignments**

Pin #		Pin #	
1	Vcc1	14	LO 3
2	HIN 1	15	LO 2
3	HIN 2	16	LO 1
4	HIN 3	18	VS 3
5	LIN 1	19	HO 3
6	LIN 2	20	VB 3
7	LIN 3	22	VS 2
8	FAULT	23	HO 2
9	ITRIP	24	VB 2
10	CAO	26	VS 1
11	CA-	27	HO 1
12	VSS	28	VB 1
13	VS0		

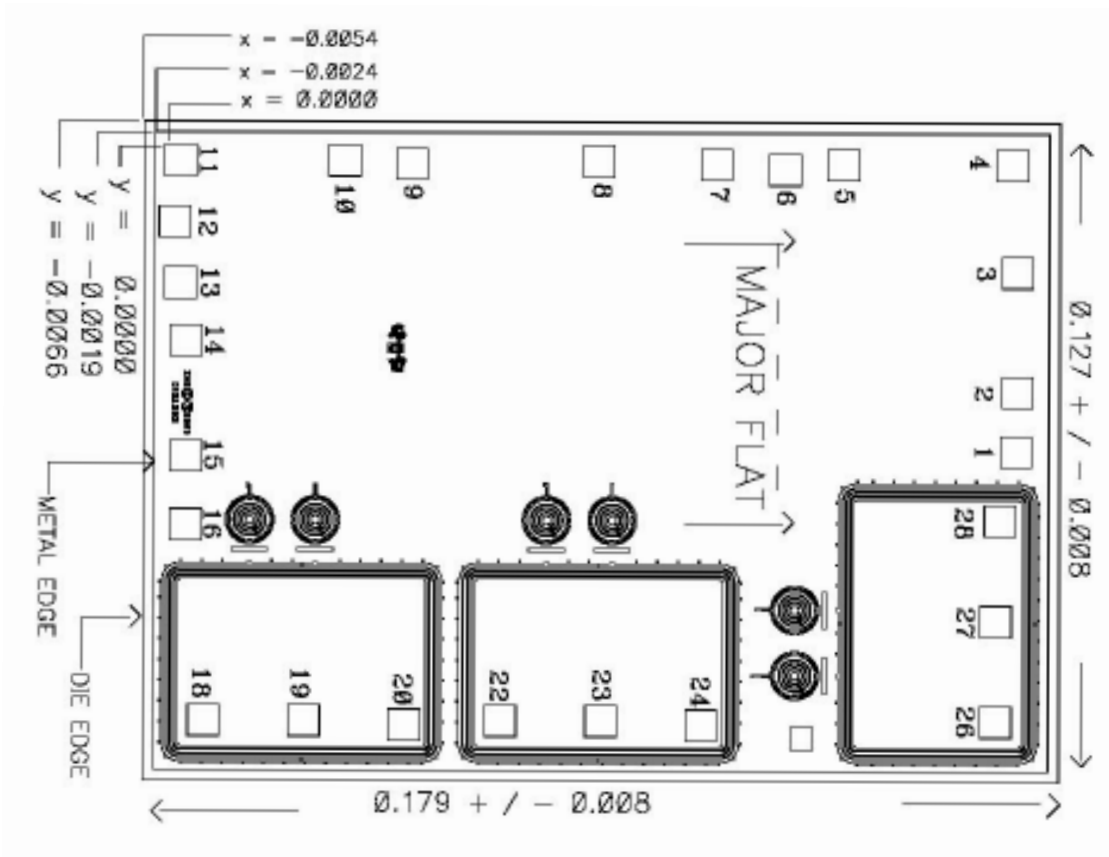

## Functional Block Diagram

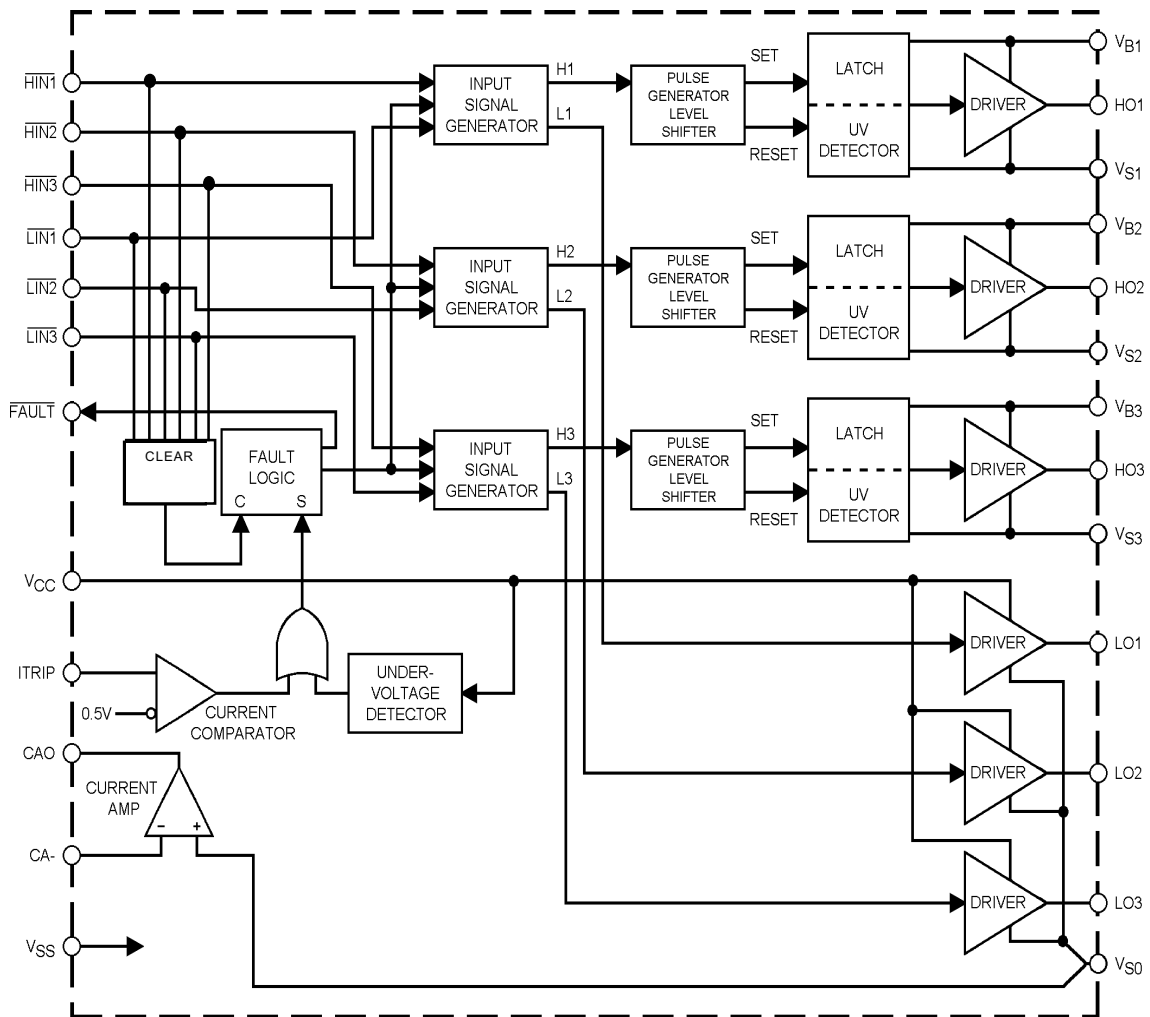

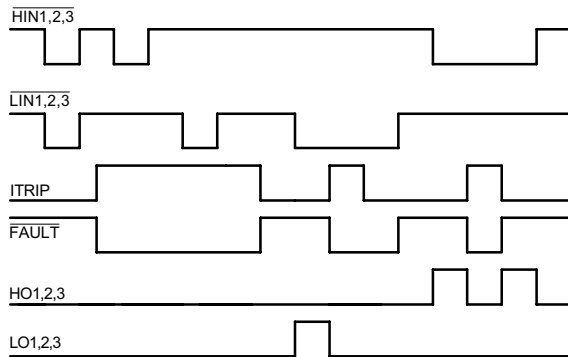

Figure 1. Input/Output Timing Diagram

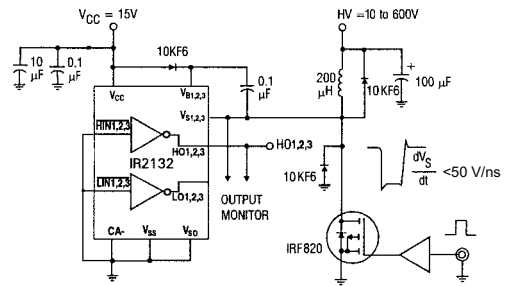

Figure 2. Floating Supply Voltage Transient Test Circuit

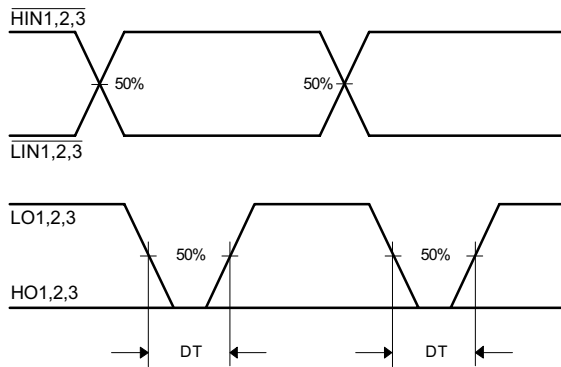

Figure 3. Deadtime Waveform Definitions

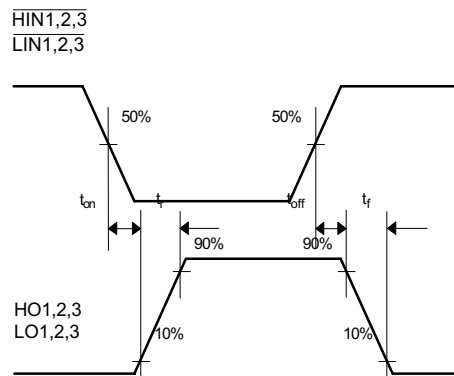
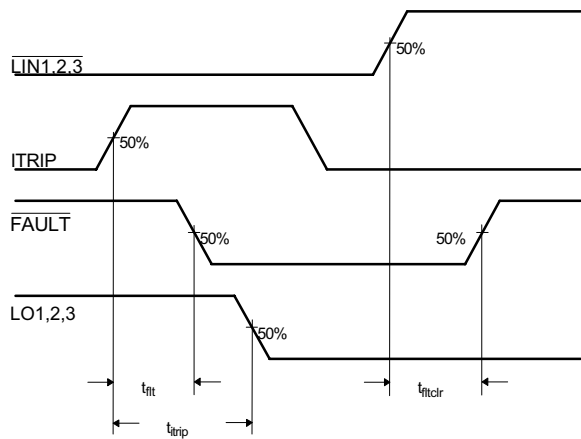
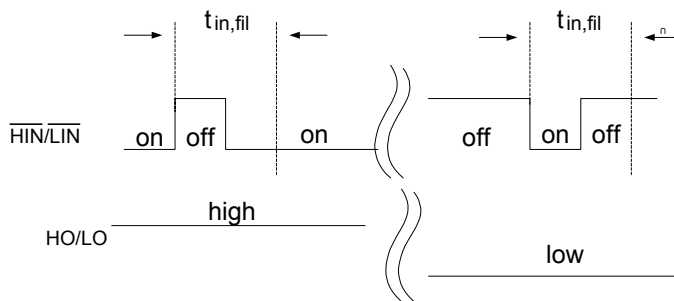

Figure 4. Input/Output Switching Time Waveform Definitions



**Figure 5. Overcurrent Shutdown Switching Time Waveform Definitions**



**Figure 5.5 Input Filter Function**

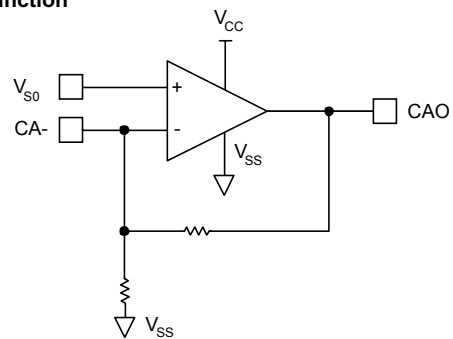

**Figure 6. Diagnostic Feedback Operational Amplifier Circuit**



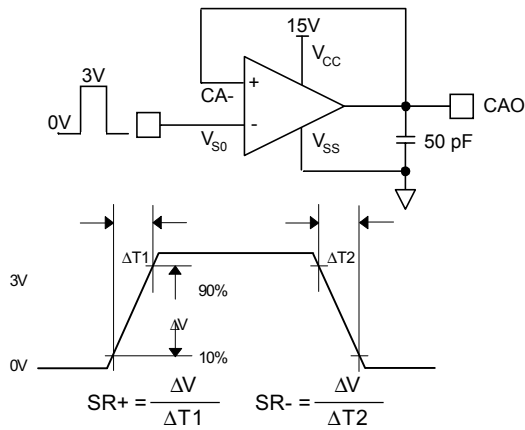

Figure 7. Operational Amplifier Slew Rate Measurement

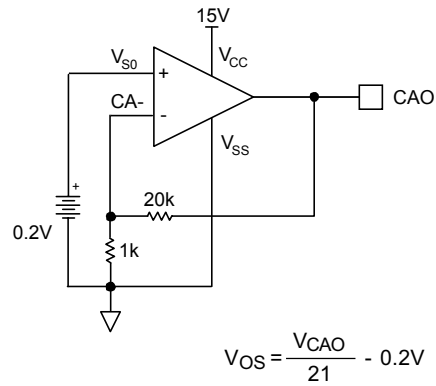

Figure 8. Operational Amplifier Input Offset Voltage Measurement

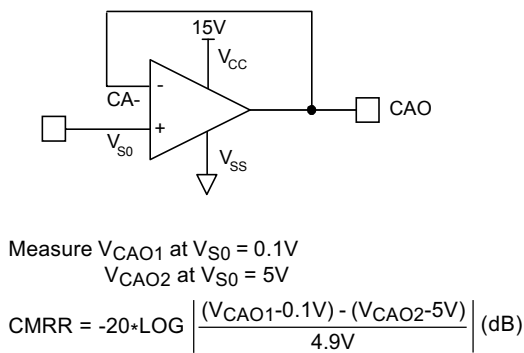

Figure 9. Operational Amplifier Common Mode Rejection Ratio Measurements

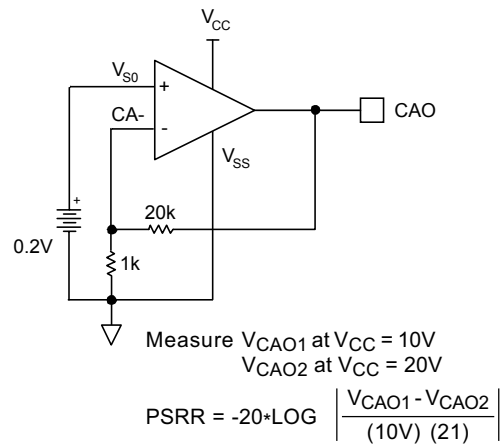

Figure 10. Operational Amplifier Power Supply Rejection Ratio Measurements

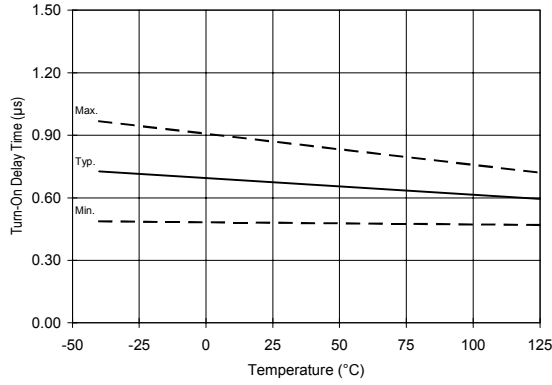

Figure 11A. Turn-On Time vs. Temperature

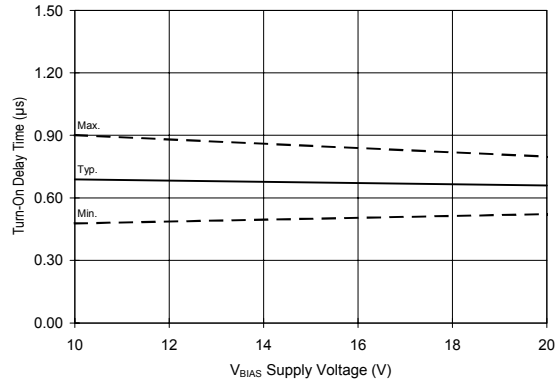

Figure 11B. Turn-On Time vs. Supply Voltage

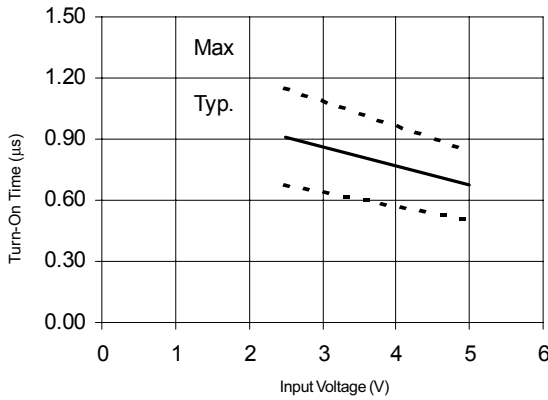

Figure 11C. Turn-On Time vs. Voltage

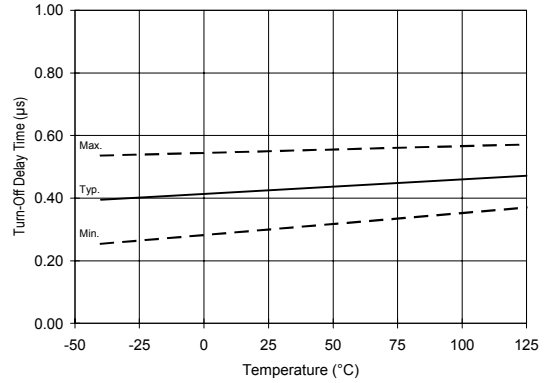

Figure 12A. Turn-Off Time vs. Temperature

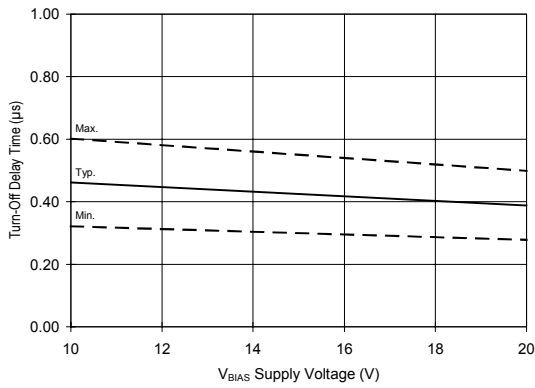

Figure 12B. Turn-Off Time vs. Supply Voltage

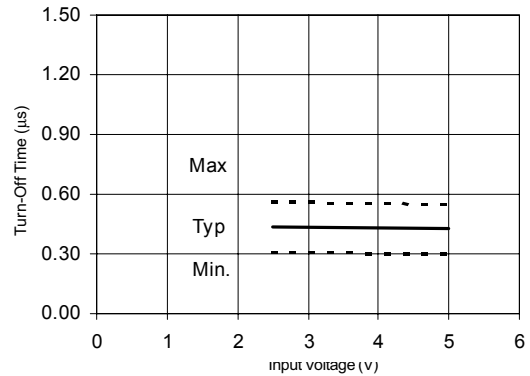

Figure 12C. Turn-Off Time vs. Input Voltage

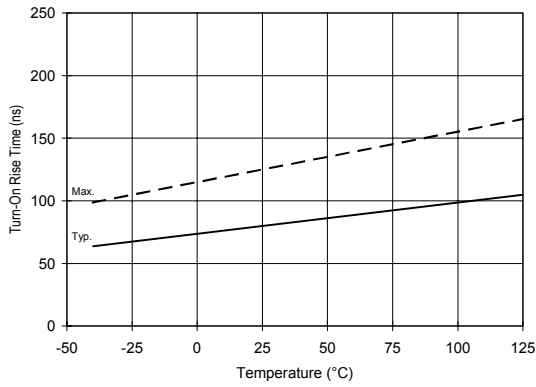

Figure 13A. Turn-On Rise Time vs. Temperature

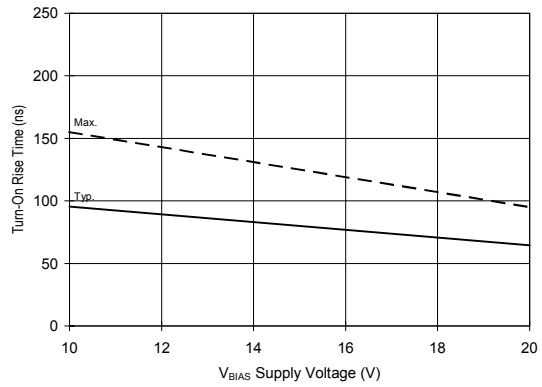

Figure 13B. Turn-On Rise Time vs. Voltage

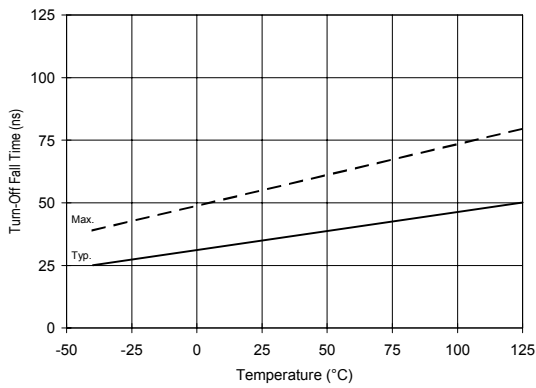

Figure 14A. Turn-Off Fall Time vs. Temperature

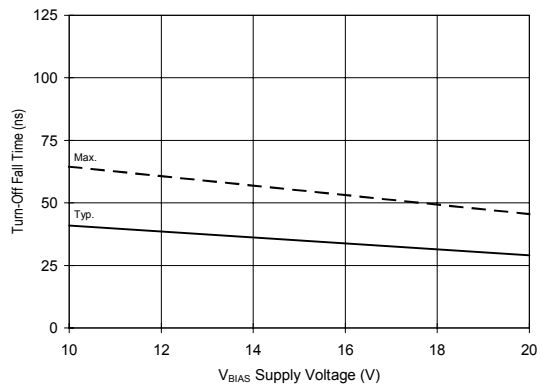

Figure 14B. Turn-Off Fall Time vs. Voltage

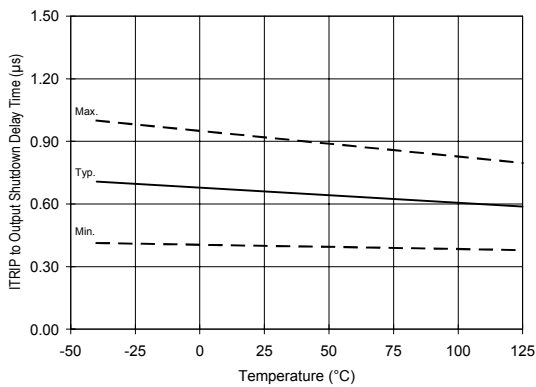

Figure 15A. ITRIP to Output Shutdown Time vs. Temperature

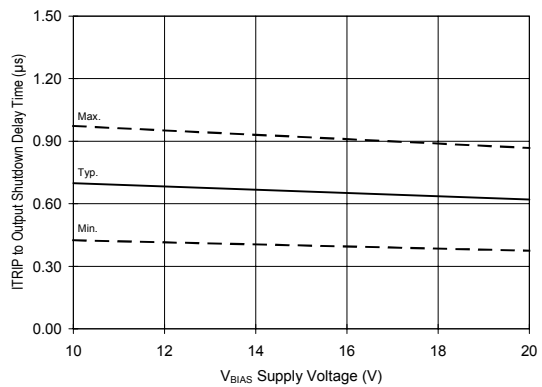
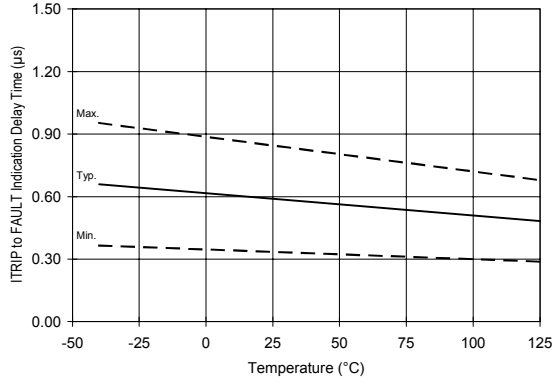
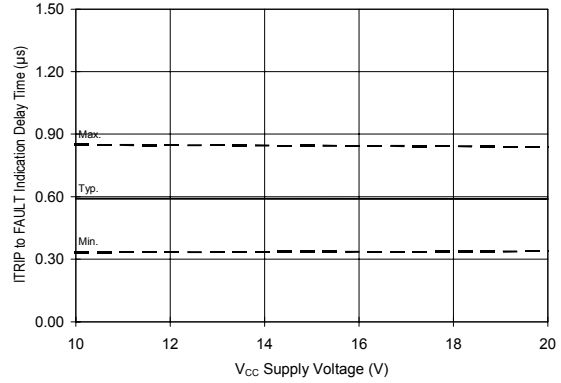

Figure 15B. ITRIP to Output Shutdown Time vs. Voltage



**Figure 16A. ITRIP to  $\overline{\text{FAULT}}$  Indication Time vs. Temperature**



**Figure 16B. ITRIP to  $\overline{\text{FAULT}}$  Indication Time vs. Voltage**

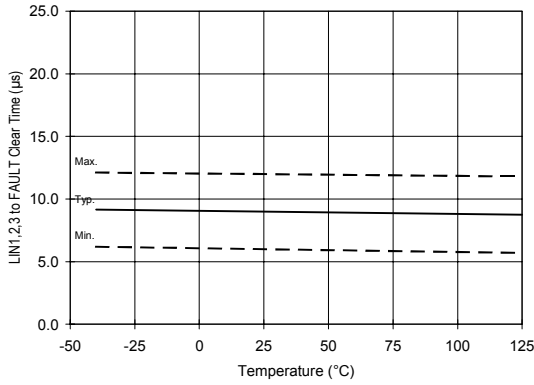

**Figure 17A.  $\overline{\text{LIN1,2,3}}$  &  $\overline{\text{HIN1,2,3}}$  to  $\overline{\text{FAULT}}$  Clear Time vs. Temperature**

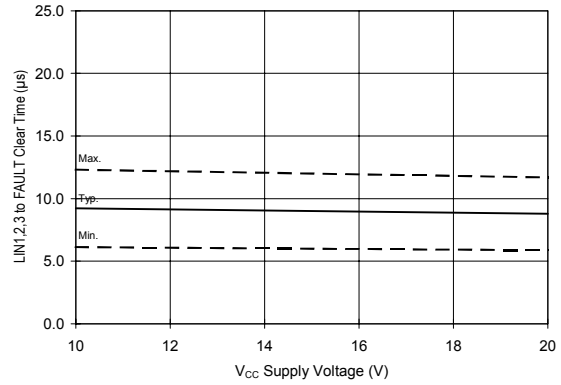

**Figure 17B.  $\overline{\text{LIN1,2,3}}$ ,  $\overline{\text{HIN1,2,3}}$  to  $\overline{\text{FAULT}}$  Clear Time vs. Voltage**

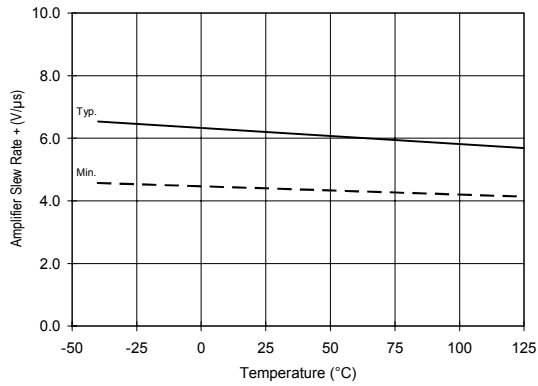

**Figure 18A. Amplifier Slew Rate (+) vs. Temperature**

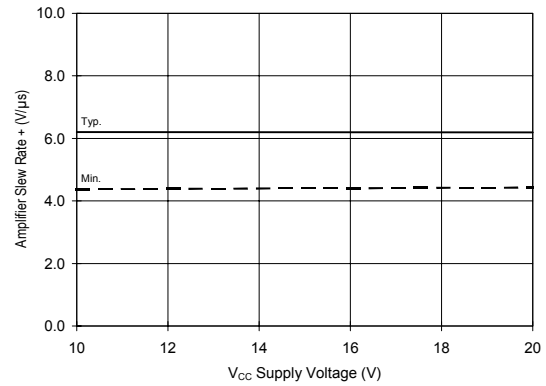

**Figure 18B. Amplifier Slew Rate (+) vs. Voltage**

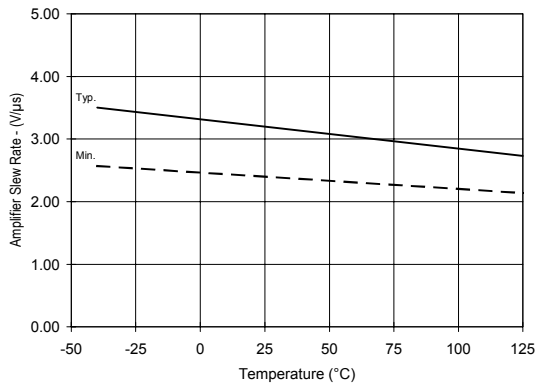

Figure 19A. Amplifier Slew Rate (-) vs. Temperature

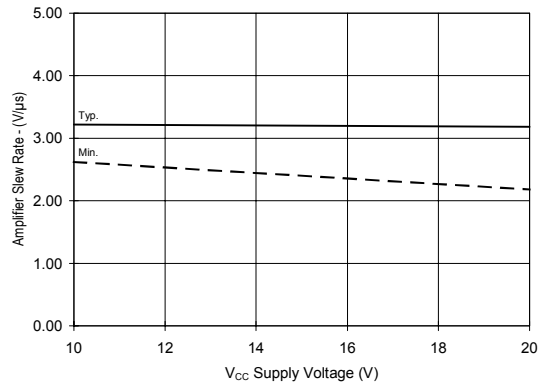

Figure 19B. Amplifier Slew Rate (-) vs. Voltage

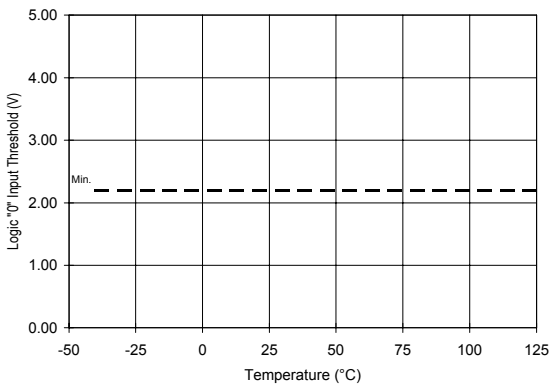

Figure 20A. Logic "0" Input Threshold vs. Temperature

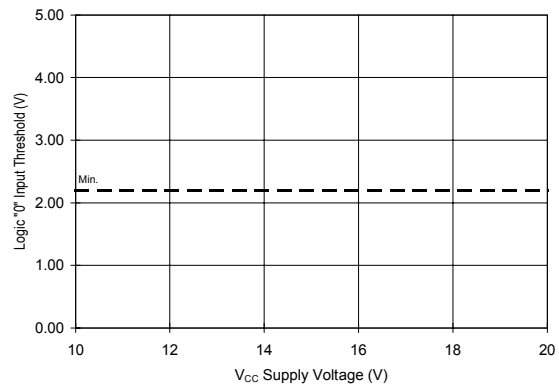

Figure 20B. Logic "0" Input Threshold vs. Voltage

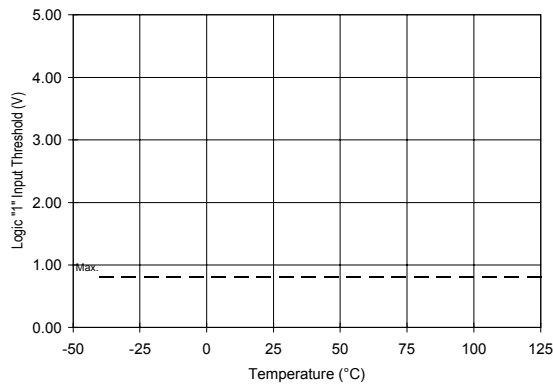

Figure 21A. Logic "1" Input Threshold vs. Temperature

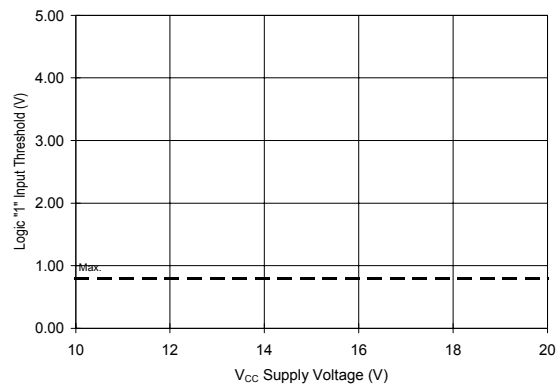
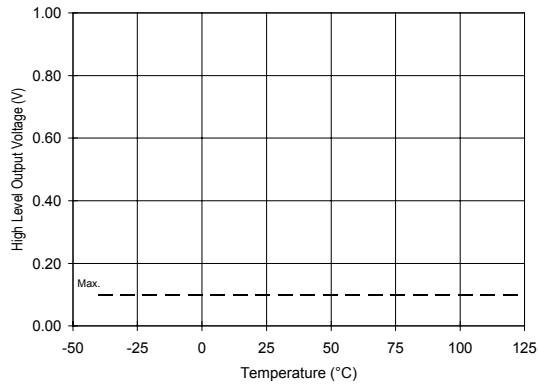
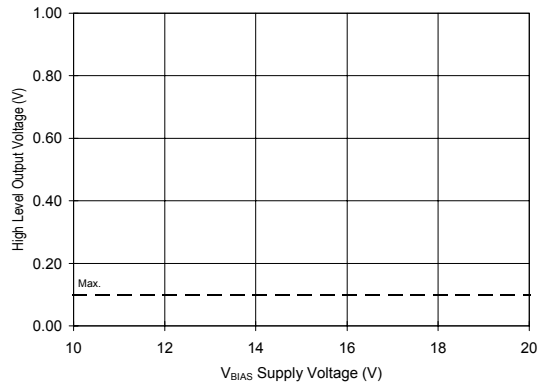

Figure 21B. Logic "1" Input Threshold vs. Voltage



**Figure 22A. High Level Output vs. Temperature**



**Figure 22B. High Level Output vs. Voltage**

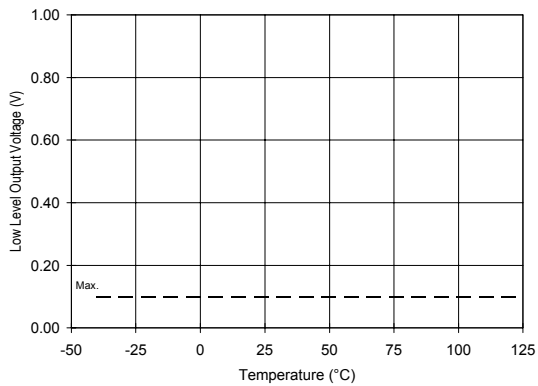

**Figure 23A. Low Level Output vs. Temperature**

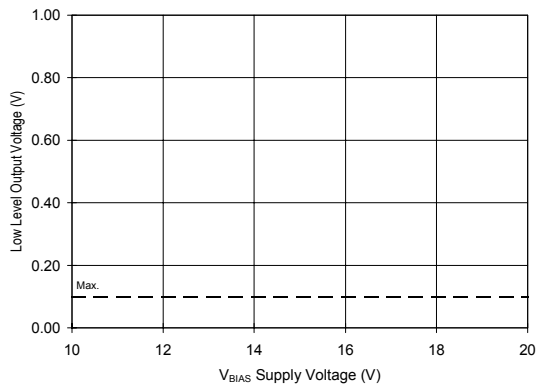

**Figure 23B. Low Level Output vs. Voltage**

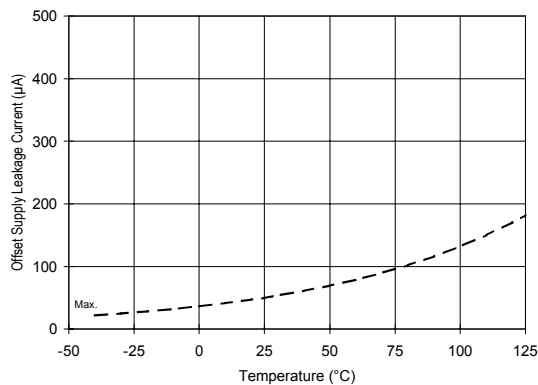

**Figure 24A. Offset Supply Leakage Current vs. Temperature**

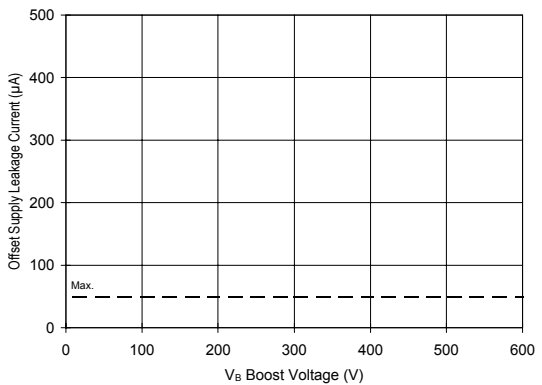

**Figure 24B. Offset Supply Leakage Current vs. Voltage**

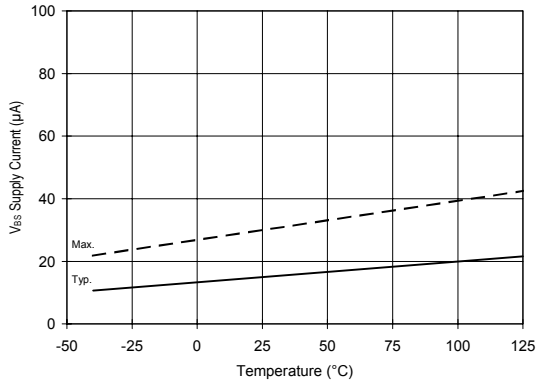

Figure 25A. V<sub>BS</sub> Supply Current vs. Temperature

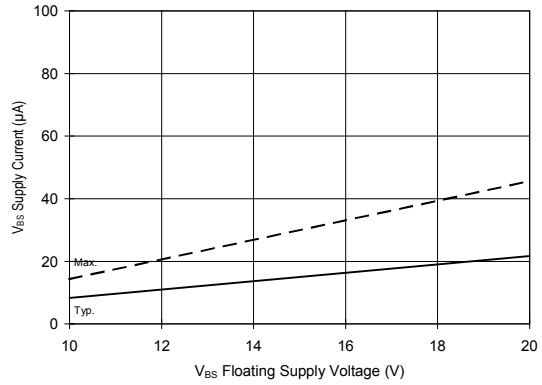

Figure 25B. V<sub>BS</sub> Supply Current vs. Voltage

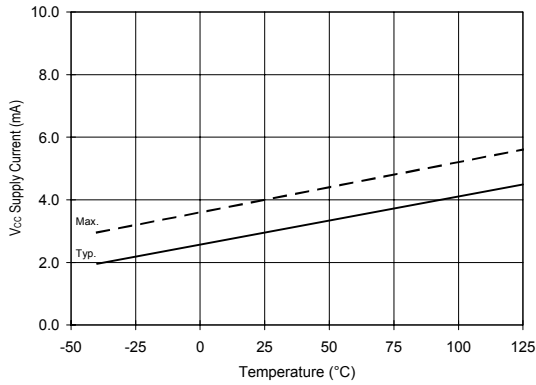

Figure 26A. V<sub>CC</sub> Supply Current vs. Temperature

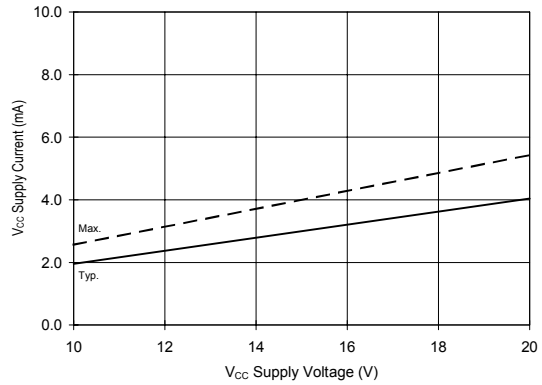

Figure 26B. V<sub>CC</sub> Supply Current vs. Voltage

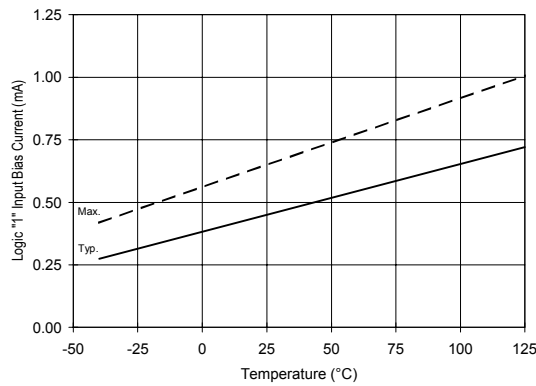

Figure 27A. Logic "1" Input Current vs. Temperature

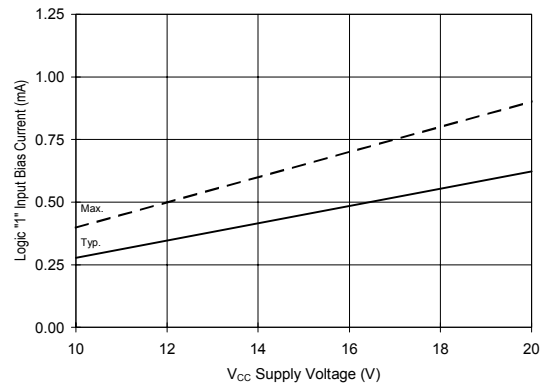

Figure 27B. Logic "1" Input Current vs. Voltage

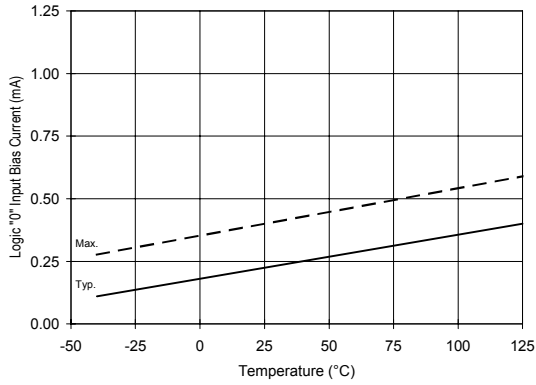

Figure 28A. Logic "0" Input Current vs. Temperature

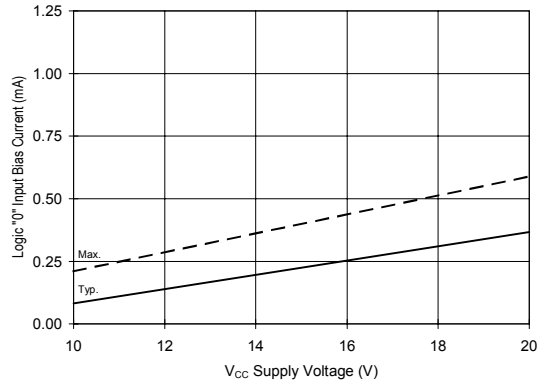

Figure 28B. Logic "0" Input Current vs. Voltage

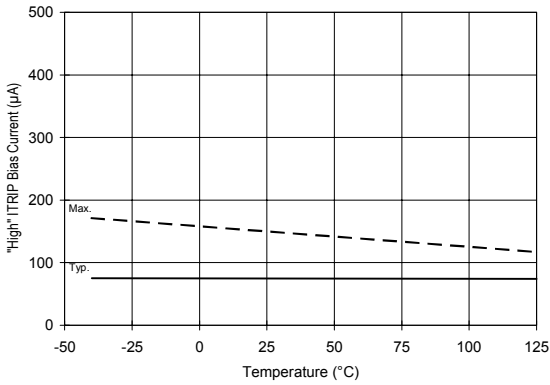

Figure 29A. "High" ITRIP Current vs. Temperature

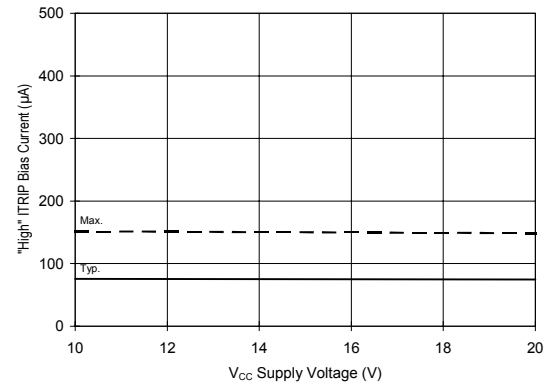

Figure 29B. "High" ITRIP Current vs. Voltage

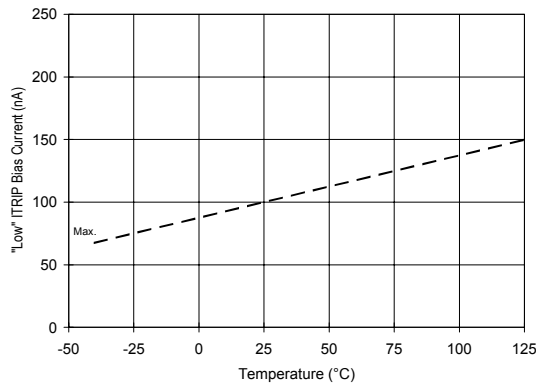

Figure 30A. "Low" ITRIP Current vs. Temperature

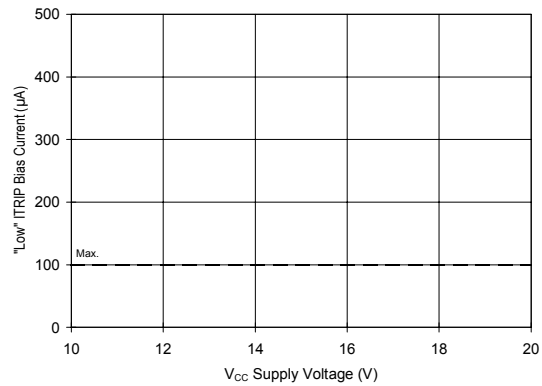

Figure 30B. "Low" ITRIP Current vs. Voltage



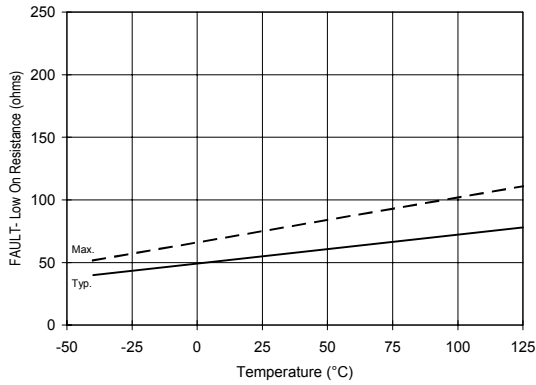

Figure 31A.  $\overline{\text{FAULT}}$  Low On Resistance vs. Temperature

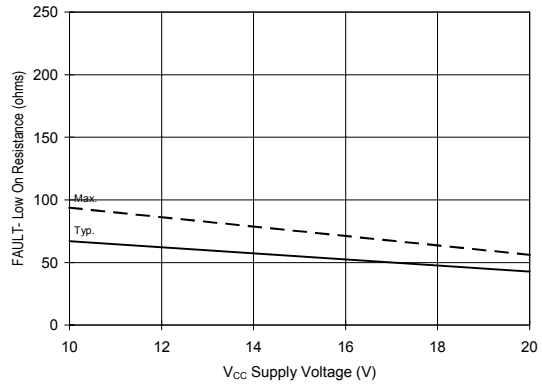

Figure 31B.  $\overline{\text{FAULT}}$  Low On Resistance vs. Voltage

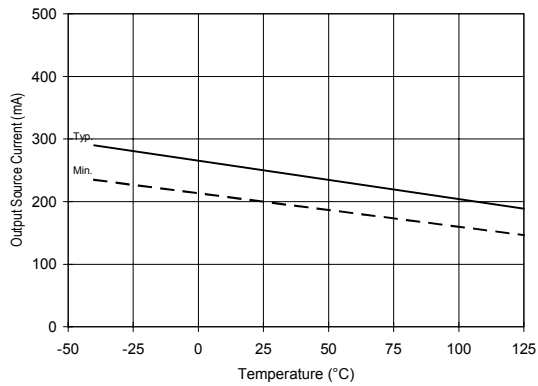

Figure 32A. Output Source Current vs. Temperature

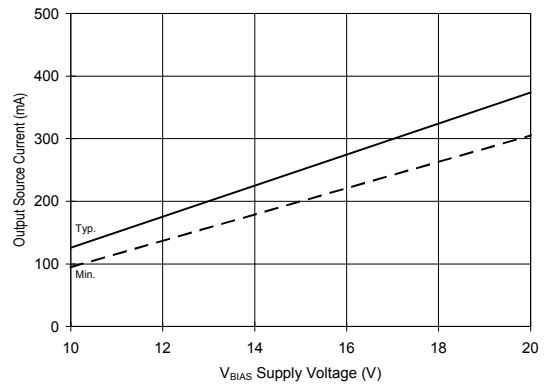

Figure 32B. Output Source Current vs. Voltage

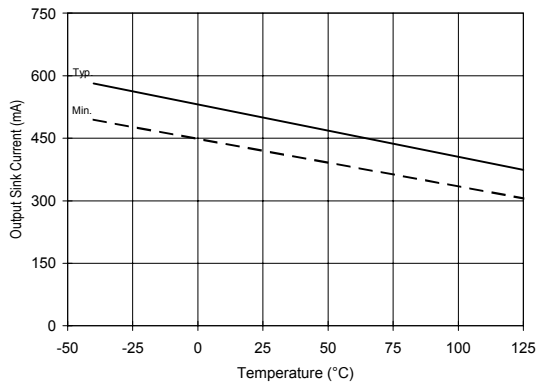

Figure 33A. Output Sink Current vs. Temperature

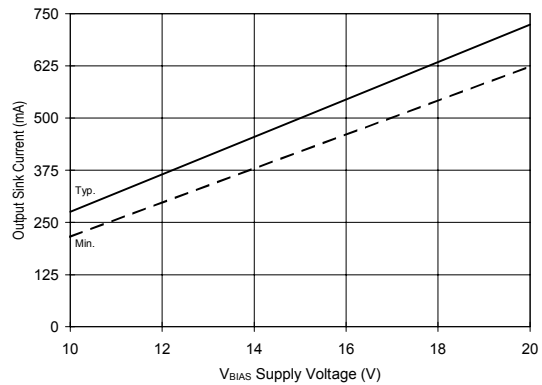
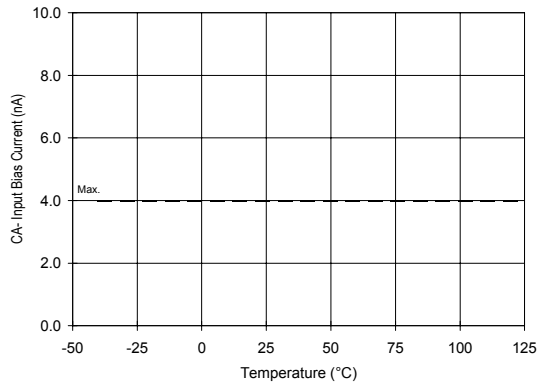
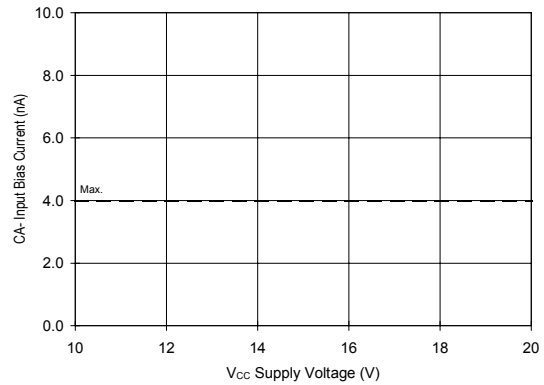

Figure 33B. Output Sink Current vs. Voltage



**Figure 34A. CA- Input Current vs. Temperature**



**Figure 34B. CA- Input Current vs. Voltage**

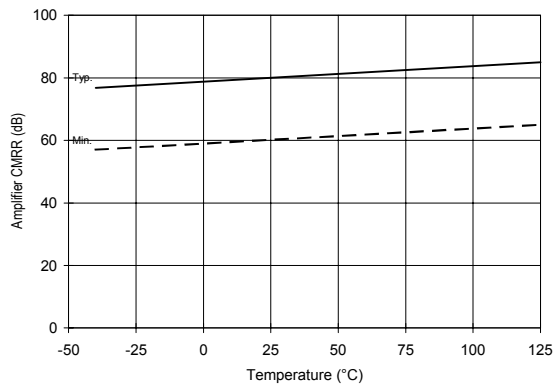

**Figure 35A. Amplifier CMRR vs. Temperature**

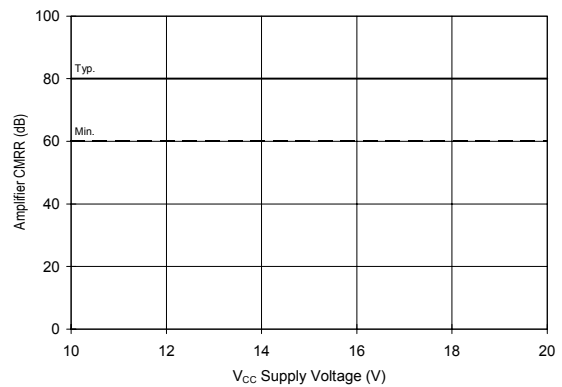

**Figure 35B. Amplifier CMRR vs. Voltage**

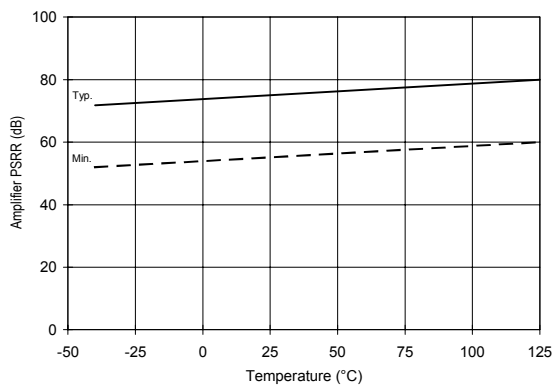

**Figure 36A. Amplifier PSRR vs. Temperature**

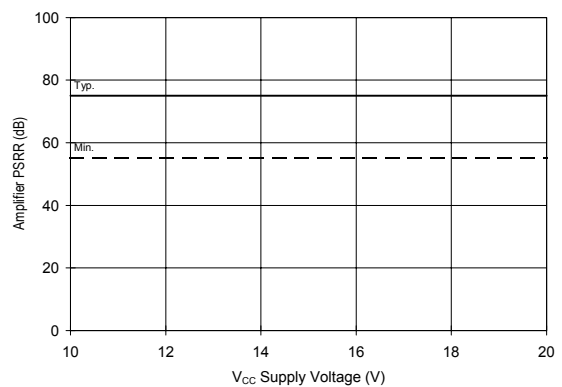

**Figure 36B. Amplifier PSRR vs. Voltage**

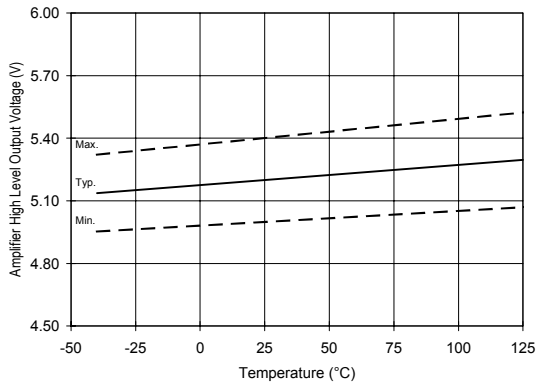

Figure 37A. Amplifier High Level Output vs. Temperature

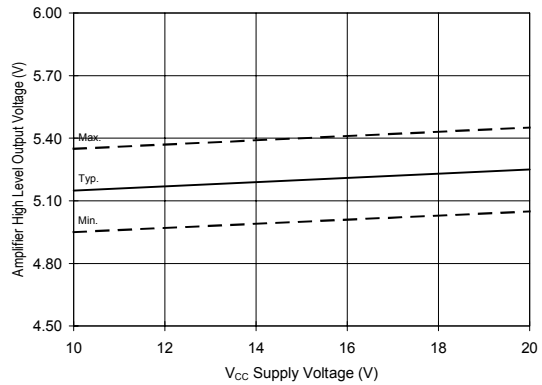

Figure 37B. Amplifier High Level Output vs. Voltage

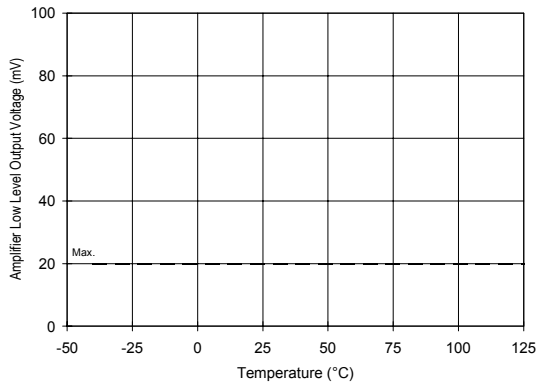

Figure 38A. Amplifier Low Level Output vs. Temperature

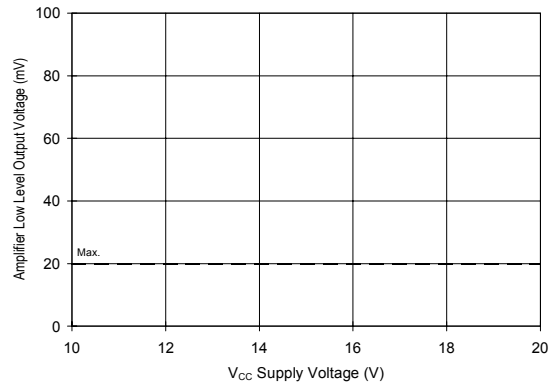

Figure 38B. Amplifier Low Level Output vs. Voltage

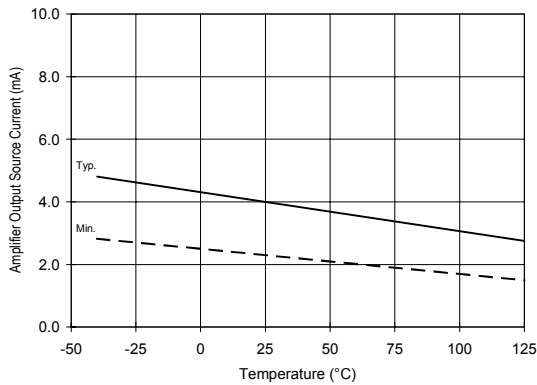

Figure 39A. Amplifier Output Source Current vs. Temperature

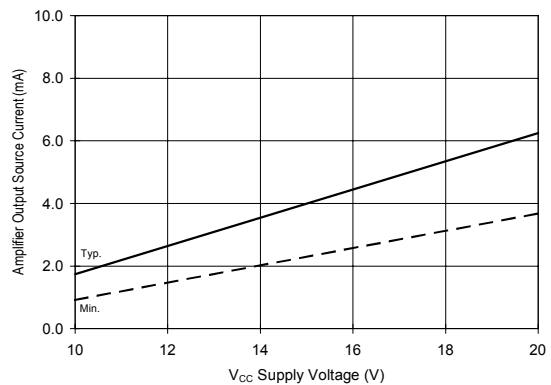
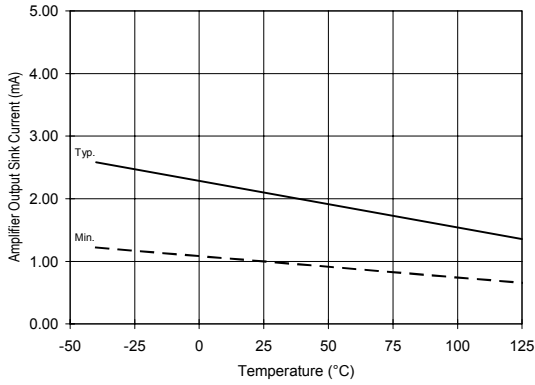
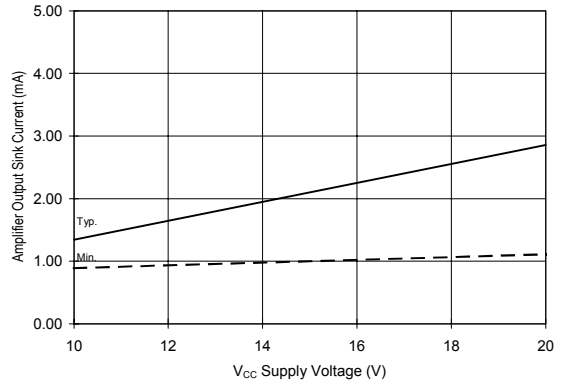

Figure 39B. Amplifier Output Source Current vs. Voltage



**Figure 40A. Amplifier Output Sink Current vs. Temperature**



**Figure 40B. Amplifier Output Sink Current vs. Voltage**

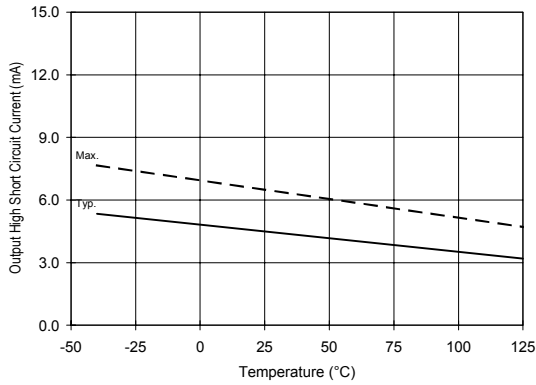

**Figure 41A. Amplifier Output High Short Circuit Current vs. Temperature**

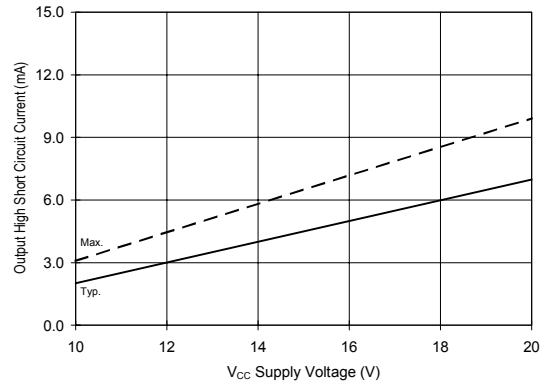

**Figure 41B. Amplifier Output High Short Circuit Current vs. Voltage**

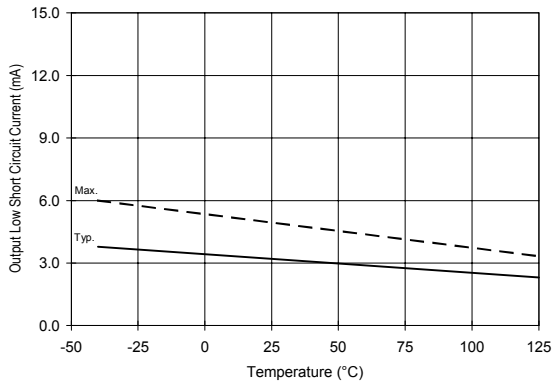

**Figure 42A. Amplifier Output Low Short Circuit Current vs. Temperature**

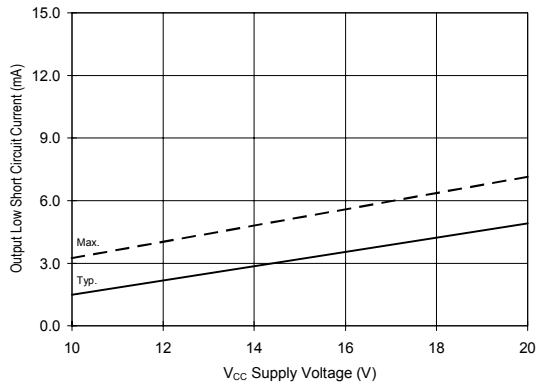

**Figure 42B. Amplifier Output Low Short Circuit Current vs. Voltage**

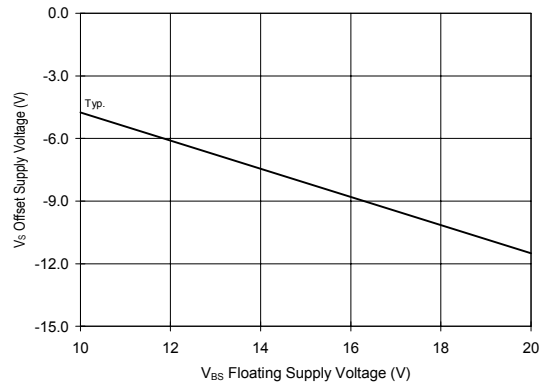

**Figure 4-3. Maximum VS Negative Offset vs. V<sub>BS</sub> Supply Voltage**