

DG1M3A

30V 1.5A

## 特長

- 超小型SMD
- 超薄型=0.8mm
- 低 $V_F=0.46V$
- 低 $I_R=0.05mA$
- $I_{FSM}=30A$

## Feature

- Ultra-small SMD
- Ultra-thin PKG=0.8mm
- Low  $V_F=0.46V$
- Low  $I_R=0.05mA$
- $I_{FSM}=30A$

## 用途

- バッテリー逆接防止
- DC/DC コンバータ

## Main Use

- Reverse connect protection for DC power source
- DC/DC Converter

## ■外観図 OUTLINE

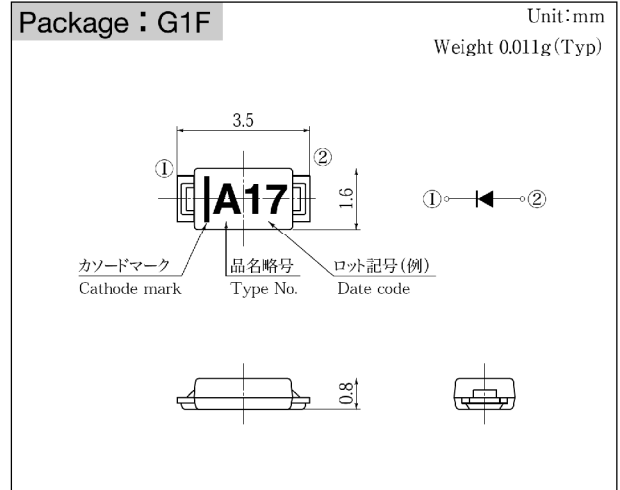

外形図については新電元Webサイト又は〈ダイオードカタログ・技術資料編〉を参照下さい。捺印表示については捺印仕様をご確認下さい。

For details of the outline dimensions, refer to our web site or the diode technical data book. As for the marking, refer to the specification "Marking, Terminal Connection".

## ■定格表 RATINGS

●絶対最大定格 Absolute Maximum Ratings (指定のない場合  $T_l=25^\circ C$ )

項目 Item	記号 Symbol	条件 Conditions	品名 Type No.	DG1M3A	単位 Unit	
保存温度 Storage Temperature	$T_{stg}$			-55~150	$^\circ C$	
接合部温度 Operation Junction Temperature	$T_j$			150	$^\circ C$	
せん頭逆電圧 Maximum Reverse Voltage	$V_{RM}$			30	V	
出力電流 Average Rectified Forward Current	$I_O$	50Hz 正弦波, 抵抗負荷 50Hz sine wave, Resistance load	$T_a=32^\circ C$	*1	1.0	A
			$T_a=37^\circ C$	*2	1.5	
せん頭サージ順電流 Peak Surge Forward Current	$I_{FSM}$	50Hz 正弦波, 非繰り返し1サイクルせん頭値, $T_j=25^\circ C$ 50Hz sine wave, Non-repetitive 1 cycle peak value, $T_j=25^\circ C$		30	A	

●電氣的・熱的特性 Electrical Characteristics (指定のない場合  $T_l=25^\circ C$ )

順電圧 Forward Voltage	$V_F$	$I_F=0.5A$ , パルス測定 Pulse measurement	MAX 0.40	V	
		$I_F=1.5A$ , パルス測定 Pulse measurement	MAX 0.46		
逆電流 Reverse Current	$I_R$	$V_R=V_{RM}$ , パルス測定 Pulse measurement	MAX 0.05	mA	
接合容量 Junction Capacitance	$C_j$	$f=1MHz, V_R=10V$	TYP 70	pF	
熱抵抗 Thermal Resistance	$\theta_{ja}$	接合部・周囲間 Junction to ambient	*1	MAX 210	$^\circ C/W$
			*2	MAX 120	
			*3	MAX 70	
	$\theta_{jl}$	接合部・リード間 Junction to lead	*3	MAX 20	

\*1 1インチプリント基板 (パターン32.6mm<sup>2</sup>)  
Measured on 1 x 1 inch substrate (pattern area : 32.6mm<sup>2</sup>)

\*2 1インチプリント基板 (パターン160mm<sup>2</sup>)  
Measured on 1 x 1 inch substrate (pattern area : 160mm<sup>2</sup>)

\*3 2インチアルミナ基板 (パターン2,100mm<sup>2</sup>)  
Measured on 2 x 2 inch alumina substrate (pattern area : 2,100mm<sup>2</sup>)

★記載内容は製品改良のためにお断りなしに変更することがあります。

★All specifications are subject to change without notice.

Small SMD

■特性図 CHARACTERISTIC DIAGRAMS

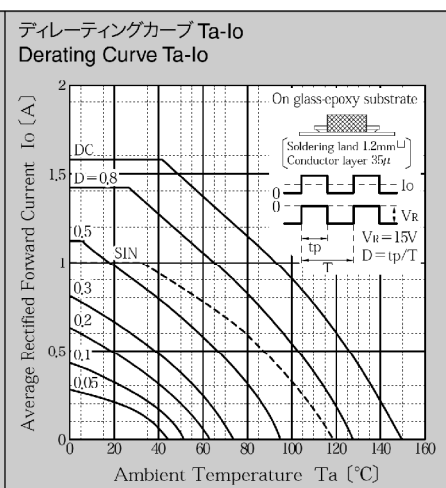
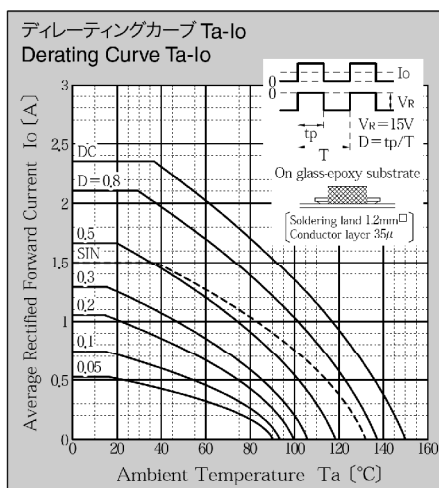
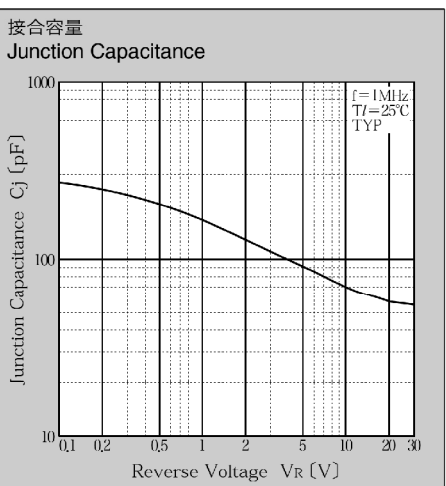
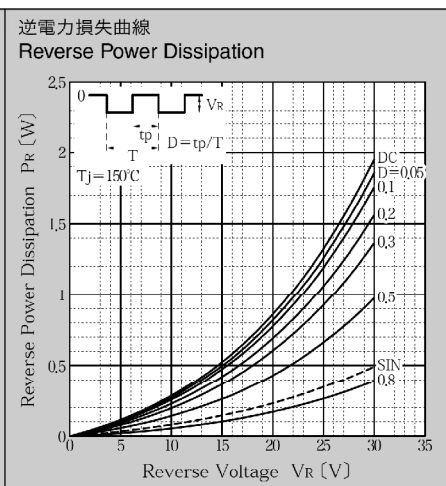
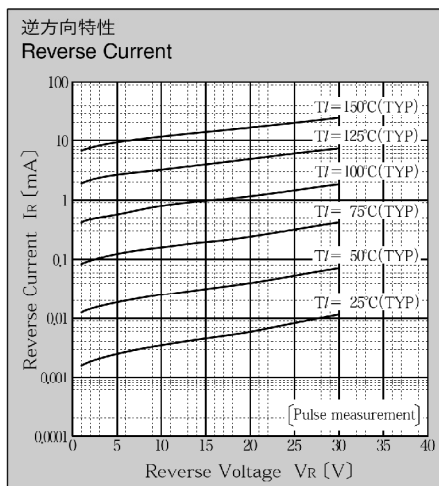
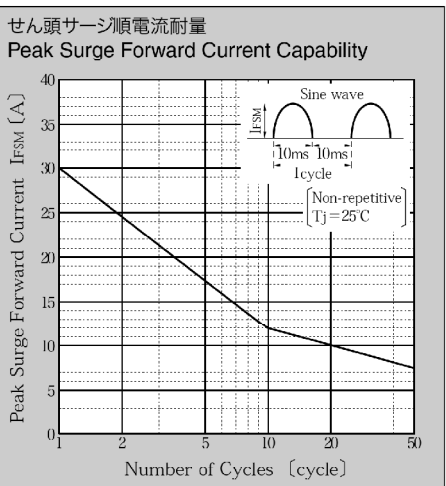
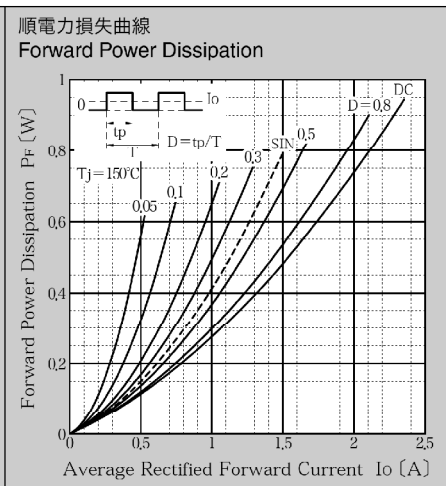
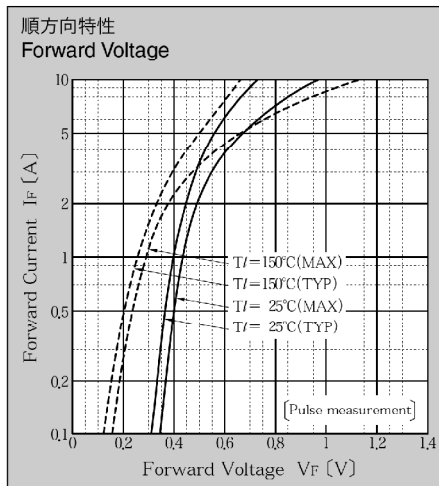

\*1インチプリント基板 (パターン160mm $^2$ )  
Measured on 1 x 1 inch substrate  
(pattern area 160mm $^2$ )

\*1インチプリント基板 (パターン32.6mm $^2$ )  
Measured on 1 x 1 inch substrate  
(pattern area 32.6mm $^2$ )

\* Sine waveは50Hzで測定しています。  
\* 50Hz sine wave is used for measurements.  
\* 半導体製品の特性は一般的にバラツキを持っています。  
Typicalは統計的な実力を表しています。  
\* Semiconductor products generally have characteristic variation.  
Typical is a statistical average of the device's ability.