



# Tri-Band HBT Power Amplifier Module

# Alpha

## AP134-501

### Features

- 3.2 V Nominal Operating Voltage
- 50  $\Omega$  Internally Matched Input and Output
- High Power Added Efficiency: 55% for GSM and 50% for DCS and PCS
- Small Size: 10 x 8 x 1.6 mm MCM Land Grid Array Package
- Low Current Standby Mode: < 10  $\mu$ A
- Integral Band Select and Analog Power Control
- GPRS Class 12 Capable

### Description

The AP134-501 is a high performance IC power amplifier module designed for use as the final amplification stage in tri-band GSM and GPRS mobile phone applications (880–915, 1710–1785 and 1850–1910 MHz). It features 3-cell battery operation, a band select switch, a single positive analog power control input for both bands, and exceptional power added efficiency. The amplifier is manufactured on an advanced InGaP HBT process, known industry-wide for its excellent reliability and performance. The amplifier module is completely self-contained, requiring no external matching components.

### -501

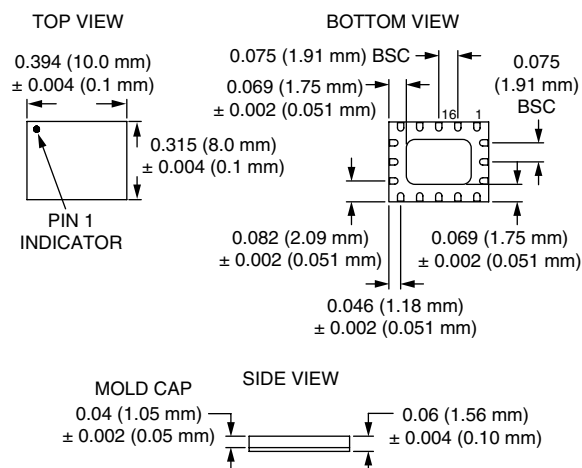

### Absolute Maximum Ratings

Characteristic	Value
Supply Voltage $V_{CC}$ , Standby Mode, $V_{APC} < 0.3$ , No RF Input Power	6 V
Power Control Voltage	4 V
Band Select Voltage	4 V
Input Power (CW)	15 dBm
Operating Case Temperature	-35 to +85°C
Storage Temperature	-45 to 120°C

### DC Specifications

Parameter	Condition	Min.	Typ.	Max.	Unit
Supply Voltage		2.8	3.2	4.2	V
Leakage Current	No RF Input Power			10	$\mu$ A
Band Select Voltage	GSM	0		0.5	V
	DCS/PCS	2.0		2.8	V
Band Select Current				1.0	mA
Power Control Voltage		0.1		1.9	V
Power Control Current				1.0	mA

## Electrical Specifications

### GSM Mode

Parameter	Condition	Min.	Typ.	Max.	Unit
Frequency		880		915	MHz
Output Power		34	35		dBm
	$V_{CC} = 2.8 \text{ V}$ , $T = -20 \text{ to } +70^\circ\text{C}$	32.5			dBm
Dynamic Range	$V_{APC} = 0.1\text{--}1.9 \text{ V}$	60			dB
Power Control Slope	$V_{APC} = 0.1\text{--}1.9 \text{ V}$		75	150	dB/V <sub>APC</sub>
Power Added Efficiency	$P_{OUT} = 34 \text{ dBm}$	50	55		%
Input Power		3	6	10	dBm
Input VSWR	$P_{OUT} = 5\text{--}35 \text{ dBm}$			2:1	
Forward Isolation	$P_{IN} = -5 \text{ dBm}$ , $V_{APC} = 0.1 \text{ V}$			-40	dBm
	$P_{IN} = 10 \text{ dBm}$ , $V_{APC} = 0.1 \text{ V}$			-25	dBm
Harmonics	$2 F_0\text{--}7 F_0$			-10	dBm
Noise in the R <sub>X</sub> Band	925 MHz, 100 KHz BW			-72	dBm
	935 MHz, 100 KHz BW			-84	dBm
	1805–1880 MHz, 100 KHz BW			-76	dBm
	1930–1990 MHz, 100 KHz BW			-76	dBm
Ruggedness	Output VSWR = 10:1 All Phase Angles, $V_{CC} = 4.2 \text{ V}$ , $P_{IN} = 10 \text{ dBm}$ , $V_{APC} = 1.9 \text{ V}$	No Module Damage or Permanent Performance Degradation			
Stability	Output VSWR = 10:1 All Phase Angles, $V_{CC} = 4.2 \text{ V}$ , $P_{IN} = 10 \text{ dBm}$ , $V_{APC} = 1.9 \text{ V}$			-36	dBm
Band to Band Isolation	$2 F_0$ Measured at DCS Output			-20	dBm
	$3 F_0$ Measured at DCS Output			-20	dBm

Unless otherwise stated: pulsed operation @ 12.5% duty cycle, 50 Ω system,  $V_{CC} = 3.2 \text{ V}$ ,  $P_{IN} = 6 \text{ dBm}$  and temperature = 25°C

### DCS/PCS Mode

Parameter	Condition	Min.	Typ.	Max.	Unit
Frequency	DCS	1710		1785	MHz
	PCS	1850		1910	MHz
Output Power		31.9	32.5		dBm
	$V_{CC} = 2.8 \text{ V}$ , $T = -20 \text{ to } +70^\circ\text{C}$	29.5			dBm
Dynamic Range	$V_{APC} = 0.1\text{--}1.9 \text{ V}$	60			dB
Power Control Slope	$V_{APC} = 0.1\text{--}1.9 \text{ V}$		75	150	dB/V <sub>APC</sub>
Power Added Efficiency	$P_{OUT} = 31.9 \text{ dBm}$	42	50		%
Input Power		3	6	10	dBm
Input VSWR	$P_{OUT} = 0\text{--}32 \text{ dBm}$			2:1	
Forward Isolation	$P_{IN} = -5 \text{ dBm}$ , $V_{APC} = 0.1 \text{ V}$			-48	dBm
	$P_{IN} = 10 \text{ dBm}$ , $V_{APC} = 0.1 \text{ V}$			-20	dBm
Harmonics	$2 F_0\text{--}7 F_0$			-10	dBm
Noise in the R <sub>X</sub> Band	1805–1880 MHz, 100 KHz BW			-76	dBm
Ruggedness	Output VSWR = 10:1 All Phase Angles, $V_{CC} = 4.2 \text{ V}$ , $P_{IN} = 10 \text{ dBm}$ , $V_{APC} = 1.9 \text{ V}$	No Module Damage or Permanent Performance Degradation			
Stability	Output VSWR = 10:1 All Phase Angles, $V_{CC} = 4.2 \text{ V}$ , $P_{IN} = 10 \text{ dBm}$ , $V_{APC} = 1.9 \text{ V}$			-36	dBm

Unless otherwise stated: pulsed operation @ 12.5% duty cycle, 50 Ω system,  $V_{CC} = 3.2 \text{ V}$ ,  $P_{IN} = 6 \text{ dBm}$  and temperature = 25°C

### Typical Performance Data

All data taken under CW conditions and include 0.2 dB of input and output fixture losses deembedded, GSM class 4 pulsed performance adds 0.5 dB of output power and 5–7% in PAE.

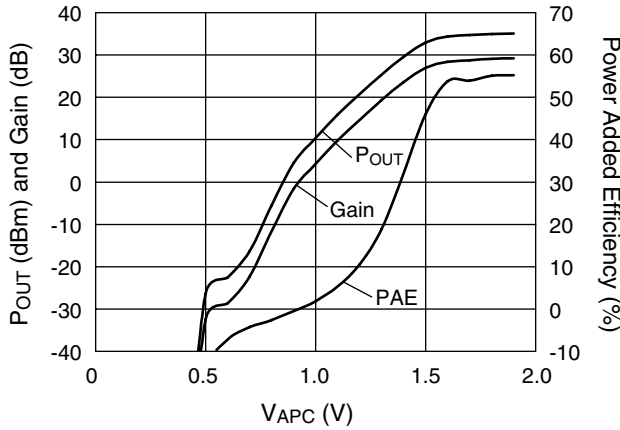

**V<sub>CC</sub> = 3.2 V, Frequency = 900 MHz, P<sub>IN</sub> = 6 dBm**

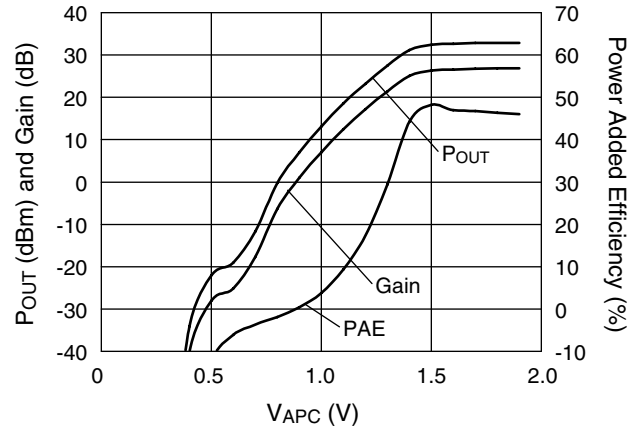

**V<sub>CC</sub> = 3.2 V, Frequency = 1750 MHz, P<sub>IN</sub> = 6 dBm**

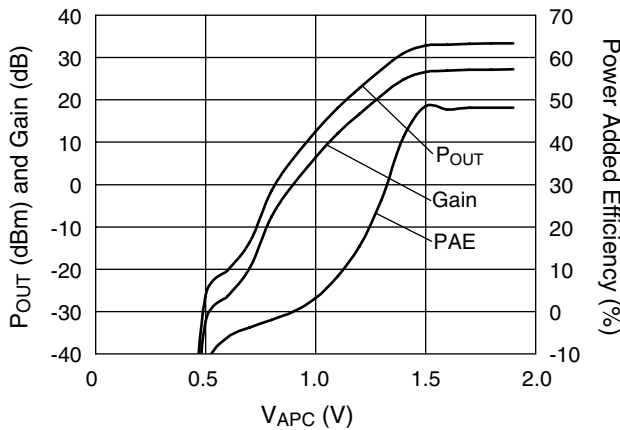

**V<sub>CC</sub> = 3.2 V, Frequency = 1910 MHz, P<sub>IN</sub> = 6 dBm**

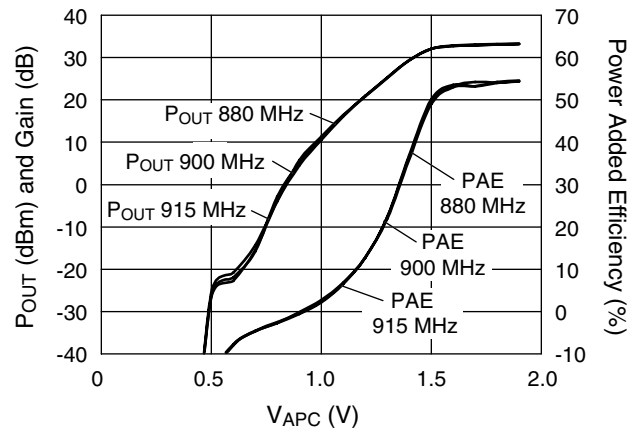

**V<sub>CC</sub> = 2.8 V, Frequency = 900 MHz, P<sub>IN</sub> = 6 dBm**

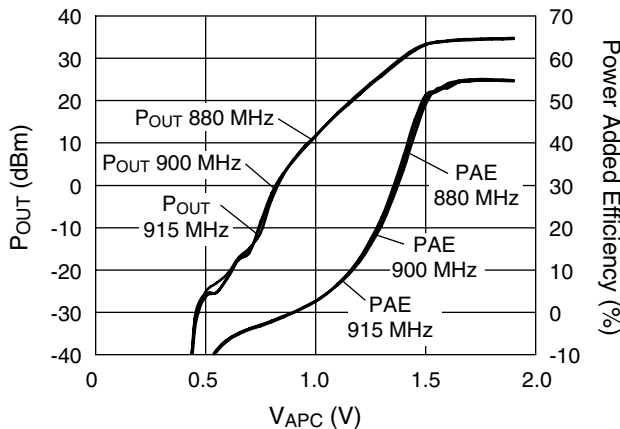

**P<sub>OUT</sub> and PAE vs. V<sub>APC</sub> and Frequency, V<sub>CC</sub> = 3.2 V, P<sub>IN</sub> = 6 dBm**

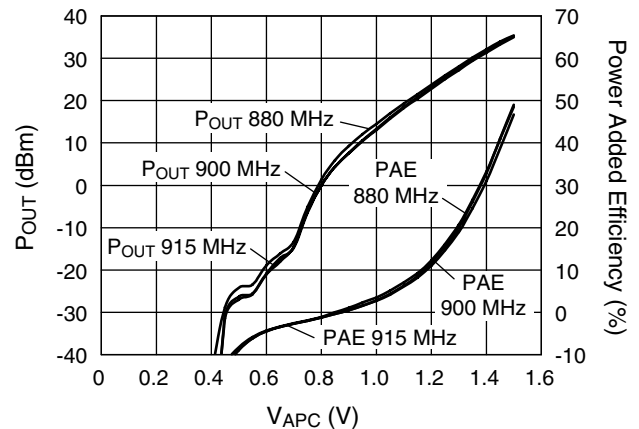

**P<sub>OUT</sub> and PAE vs. V<sub>APC</sub> and Frequency, V<sub>CC</sub> = 4.2 V, P<sub>IN</sub> = 6 dBm**

All data taken under CW conditions and include 0.2 dB of input and output fixture losses deembedded, GSM class 4 pulsed performance adds 0.5 dB of output power and 5-7% in PAE.

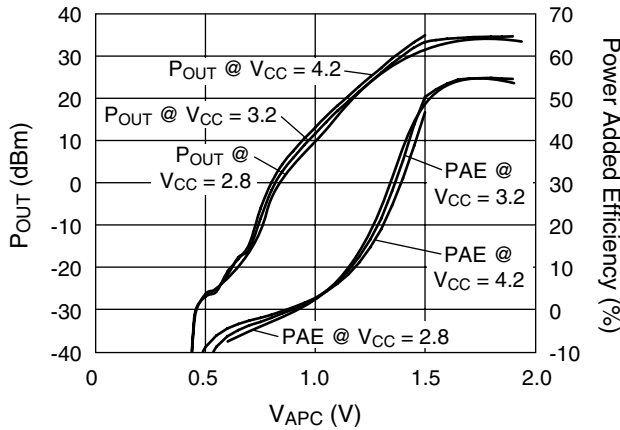

**POUT and PAE vs. VCC and VAPC**  
 $P_{IN} = 6 \text{ dBm}$

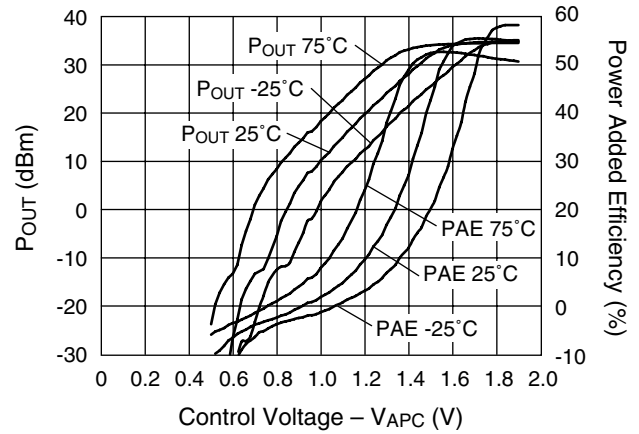

**POUT and PAE vs. Temperature**  
 $V_{CC} = 3.2 \text{ V}$ ,  $P_{IN} = 6 \text{ dBm}$ ,  
 Frequency = 880 MHz

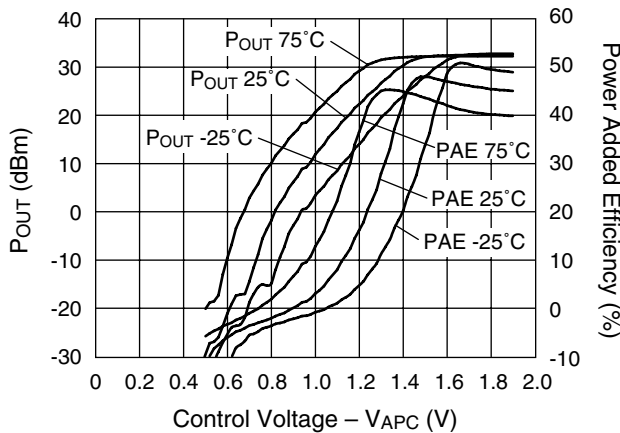

**POUT and PAE vs. Temperature**  
 $V_{CC} = 3.2 \text{ V}$ ,  $P_{IN} = 6 \text{ dBm}$ ,  
 Frequency = 1710 MHz

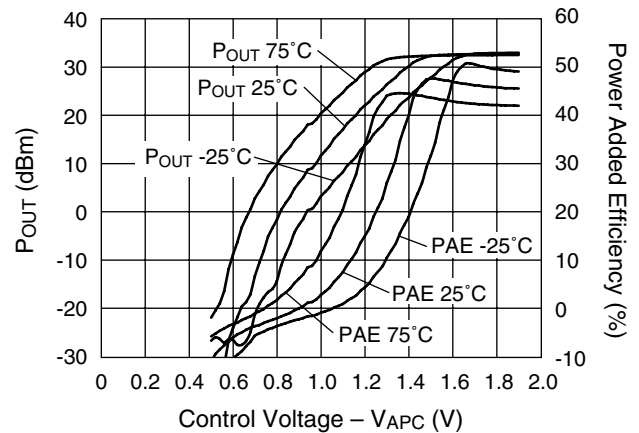

**POUT and PAE vs. Temperature**  
 $V_{CC} = 3.2 \text{ V}$ ,  $P_{IN} = 6 \text{ dBm}$ ,  
 Frequency = 1850 MHz

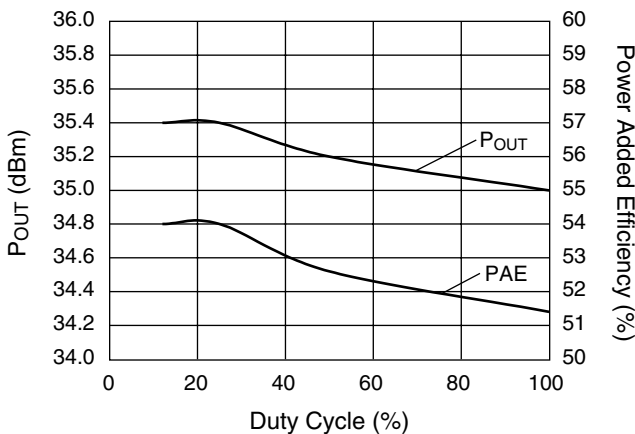

**Duty Cycle Effects on Module Performance**  
 $V_{CC} = 3.2 \text{ V}$ , Frequency = 900 MHz,  
 $P_{IN} = 6 \text{ dBm}$

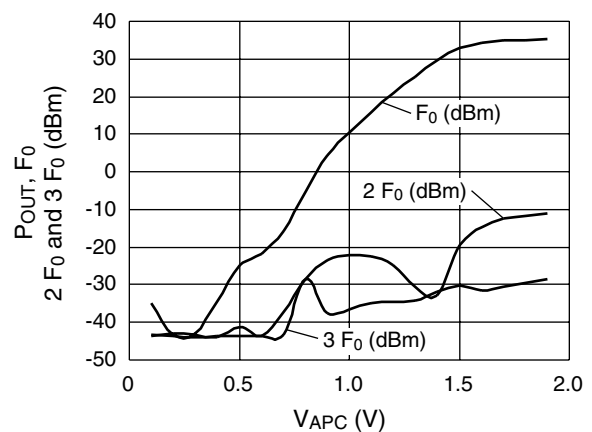

**Harmonic Performance**  $V_{CC} = 3.2 \text{ V}$ ,  
 Frequency = 900 MHz,  $P_{IN} = 6 \text{ dBm}$

### Pin Out

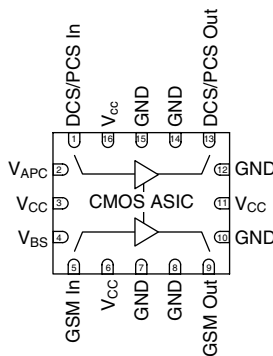

### Application Schematic

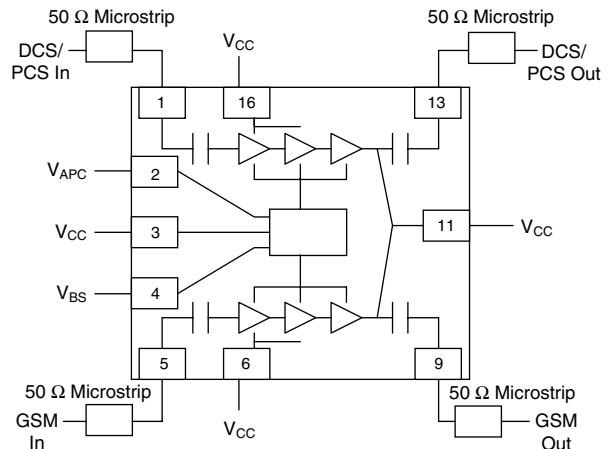

### Pin Out Description

Pin	Symbol	Description
1	DCS/PCS_In	RF input to DCS/PCS power amplifier.
2	V <sub>APC</sub>	Analog power control input voltage. 10 nF RF bypassing capacitor recommended.
3	V <sub>CC</sub>	Power supply input voltage. A 10 μF RF bypassing capacitor is required. This capacitor is only required to help reduce power supply ripple on the test board.
4	V <sub>BS</sub>	Band select input voltage.
5	GSM_In	RF input to GSM power amplifier.
6	V <sub>CC</sub>	Power supply input voltage. 10 μF RF bypassing capacitor is required. This capacitor is only required to help reduce power supply ripple on the test board.
7	GND	Ground connection.
8	GND	Ground connection.
9	GSM_Out	RF output for GSM amplifier.
10	GND	Ground connection.
11	V <sub>CC</sub>	Power supply input voltage. 10 μF RF bypassing capacitor is required. This capacitor is only required to help reduce power supply ripple on the test board.
12	GND	Ground connection.
13	DCS/PCS_Out	RF output for DCS/PCS power amplifier.
14	GND	Ground connection.
15	GND	Ground connection.
16	V <sub>CC</sub>	Power supply input voltage. 10 μF RF bypassing capacitor is required. This capacitor is only required to help reduce power supply ripple on the test board.