

SANYO	No.4630	2SK2046
		N-Channel MOS Silicon FET

Very High-Speed Switching Applications

Features

- Low ON resistance.
- Very high-speed switching.
- Low-voltage drive.

Absolute Maximum Ratings at Ta = 25°C

Drain-to-Source Voltage	V _{DSS}		30	V
Gate-to-Source Voltage	V _{GSS}		±15	V
Drain Current (DC)	I _D		12	A
Drain Current (Pulse)	I _{DP}	PW ≤ 10μs, duty cycle ≤ 1%	48	A
Allowable Power Dissipation	P _D	Tc = 25°C	30	W
Channel Temperature	T _{ch}		150	°C
Storage Temperature	T _{stg}		-55 to +150	°C

Electrical Characteristics at Ta = 25°C

			min	typ	max	
D-S Breakdown Voltage	V _{(BR)DSS}	I _D = 1mA, V _{GS} = 0	30			V
G-S Breakdown Voltage	V _{(BR)GSS}	I _G = ±100μA, V _{DS} = 0	±15			V
Zero Gate Voltage Drain Current	I _{DSS}	V _{DS} = 30V, V _{GS} = 0			100	μA
Gate-to-Source Leakage Current	I _{GSS}	V _{GS} = ±12V, V _{DS} = 0			±10	μA
Cutoff Voltage	V _{GS(off)}	V _{DS} = 10V, I _D = 1mA	1.0		2.0	V
Forward Transfer Admittance	Y _{fs}	V _{DS} = 10V, I _D = 4A	5	8		S
Static Drain-to-Source on State Resistance	R _{DS(on)}	I _D = 4A, V _{GS} = 10V	24	35	50	mΩ
	R _{DS(on)}	I _D = 4A, V _{GS} = 4V		50	70	mΩ
Input Capacitance	C _{iss}	V _{DS} = 10V, f = 1MHz		1000		pF
Output Capacitance	C _{oss}	V _{DS} = 10V, f = 1MHz		550		pF
Reverse Transfer Capacitance	C _{rss}	V _{DS} = 10V, f = 1MHz		180		pF
Turn-ON Delay Time	t _{d(on)}	See specified Test Circuit		13		ns
Rise Time	t _r	"		40		ns
Turn-OFF Delay Time	t _{d(off)}	"		130		ns
Fall Time	t _f	"		120		ns
Diode Forward Voltage	V _{SD}	I _S = 8A, V _{GS} = 0		1.0	1.5	V
Drain Current	I _{DSX}	V _{DS} = 5V, V _{GS} = 0.1V			0.5	μA

Switching Time Test Circuit

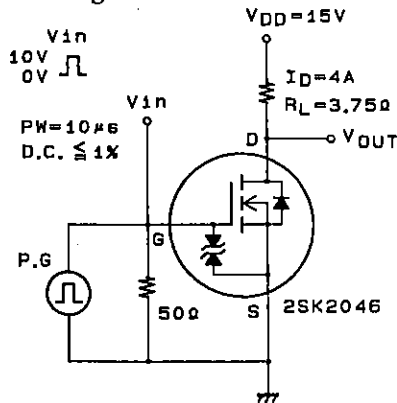

A01786

Package Dimensions 2083B

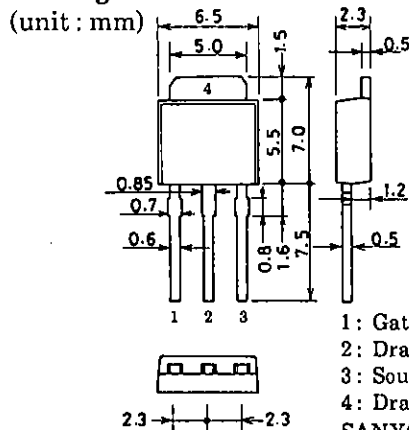

1: Gate
2: Drain
3: Source
4: Drain
SANYO : TP

Package Dimensions 2092B

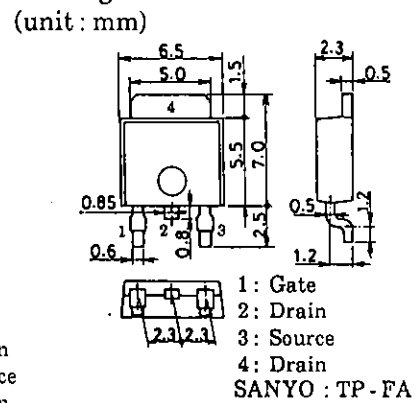

1: Gate
2: Drain
3: Source
4: Drain
SANYO : TP-FA

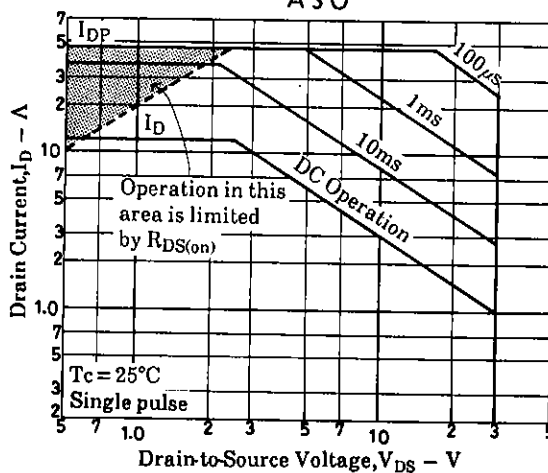
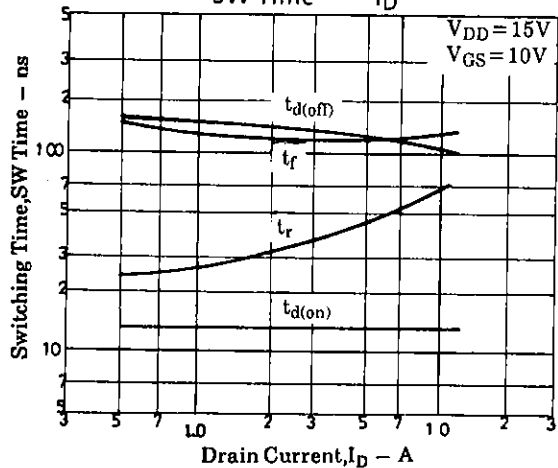
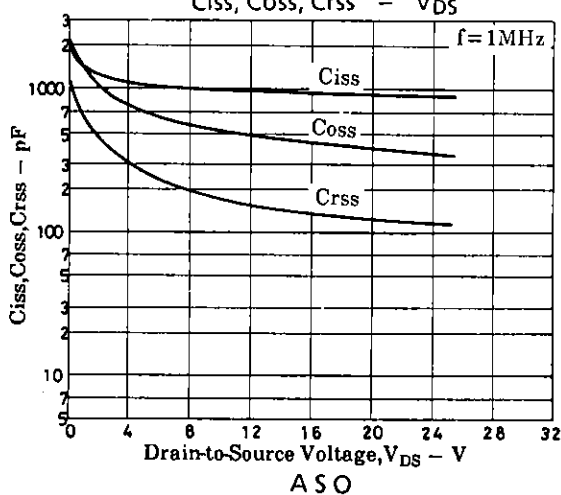
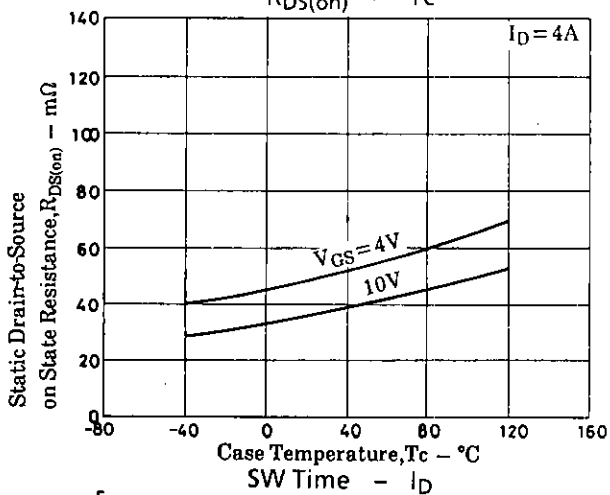
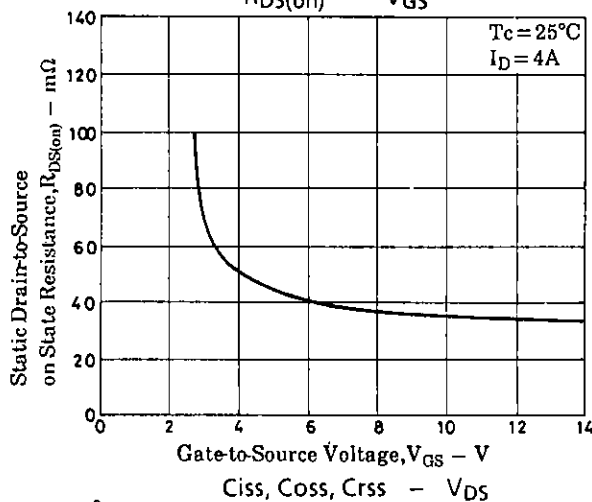
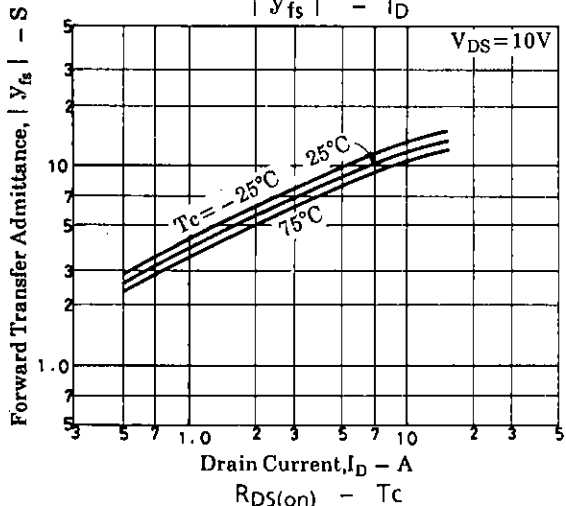
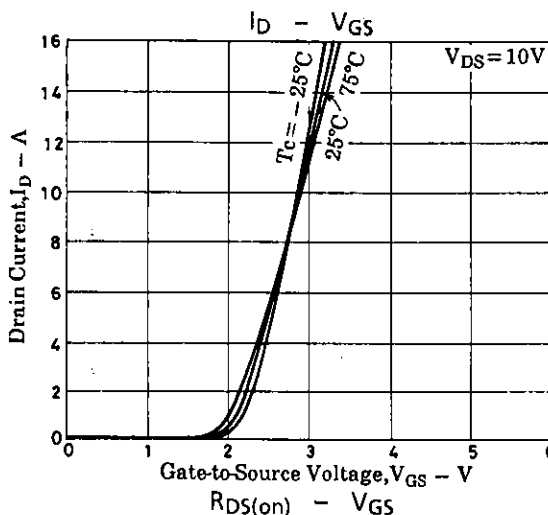
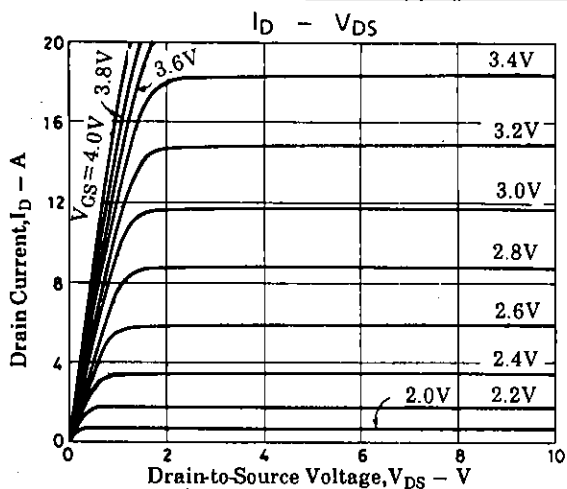

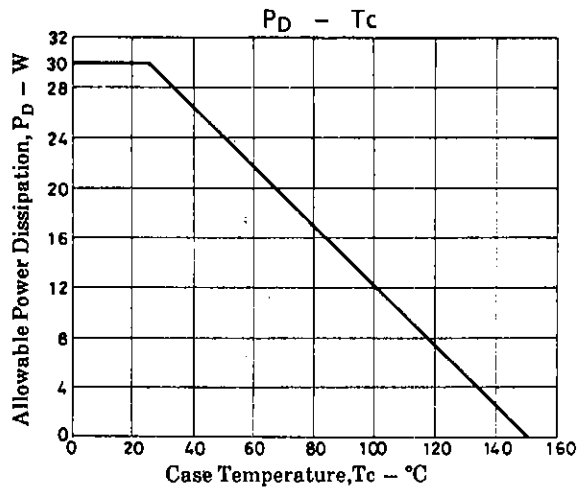

- No products described or contained herein are intended for use in surgical implants, life-support systems, aerospace equipment, nuclear power control systems, vehicles, disaster/crime-prevention equipment and the like, the failure of which may directly or indirectly cause injury, death or property loss.
- Anyone purchasing any products described or contained herein for an above-mentioned use shall:
 - ① Accept full responsibility and indemnify and defend SANYO ELECTRIC CO., LTD., its affiliates, subsidiaries and distributors and all their officers and employees, jointly and severally, against any and all claims and litigation and all damages, cost and expenses associated with such use:
 - ② Not impose any responsibility for any fault or negligence which may be cited in any such claim or litigation on SANYO ELECTRIC CO., LTD., its affiliates, subsidiaries and distributors or any of their officers and employees jointly or severally.
- Information (including circuit diagrams and circuit parameters) herein is for example only; it is not guaranteed for volume production. SANYO believes information herein is accurate and reliable, but no guarantees are made or implied regarding its use or any infringements of intellectual property rights or other rights of third parties.