

NPN MPSA06
PNP MPSA56

FEATURES

- *Collector-Emitter Voltage: $V_{CE0}=80V$
- *Collector Dissipation: $P_D=625mW$

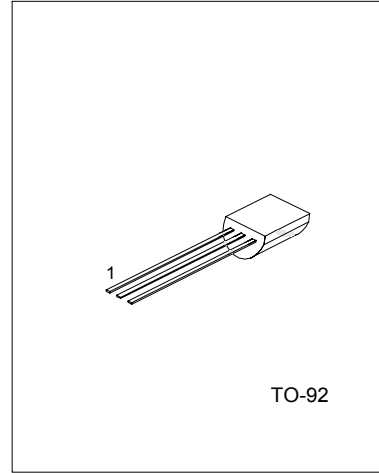

1: EMITTER 2: BASE 3: COLLECTOR

ABSOLUTE MAXIMUM RATINGS ($T_A=25^{\circ}C$, unless otherwise specified)

PARAMETER	SYMBOL	RATING	UNIT
Collector-base voltage	V_{CB0}	80	V
Collector-emitter voltage	V_{CE0}	80	V
Emitter-base voltage	V_{EB0}	4	V
Collector current - Continuous	I_C	500	mA
Total device dissipation, @ $T_A=25^{\circ}C$	P_D	625	mW
Derate above $25^{\circ}C$		5	mW/ $^{\circ}C$
Total device dissipation, @ $T_C=25^{\circ}C$	P_D	1500	mW
Derate above $25^{\circ}C$		12	mW/ $^{\circ}C$
Junction Temperature	T_J	-55 ~ +150	$^{\circ}C$
Storage Temperature	T_{STG}	-55 ~ +150	$^{\circ}C$

THERMAL CHARACTERISTICS

PARAMETER	SYMBOL	MAX	UNIT
Thermal resistance, junction to ambient	$R_{\theta JA}$ (note)	200	$^{\circ}C/W$
Thermal resistance, junction to case	$R_{\theta JC}$	83.3	$^{\circ}C/W$

Note: $R_{\theta JA}$ is measured with the device soldered into a typical printed circuit board.

ELECTRICAL CHARACTERISTICS ($T_a=25^{\circ}C$, unless otherwise specified)

PARAMETER	SYMBOL	TEST CONDITIONS	MIN	TYP	MAX	UNIT
OFF CHARACTERISTICS						
Collector-emitter breakdown voltage (note 1)	$V_{(BR)CEO}$	$I_C=1.0mA, I_B=0$	80			V
Emitter-base breakdown voltage	$V_{(BR)EBO}$	$I_E=100\mu A, I_C=0$	4			V
Collector cutoff current	I_{CES}	$V_{CE}=60V, I_B=0$			0.1	μA
Collector cutoff current	I_{CBO}	$V_{CB}=80V, I_E=0$			0.1	μA

UTC MPSA06/56

AMPLIFIER TRANSISTOR

PARAMETER	SYMBOL	TEST CONDITIONS	MIN	TYP	MAX	UNIT
ON CHARACTERISTICS						
DC current gain	h_{FE}	$I_C=10\text{mA}, V_{CE}=1\text{V}$ $I_C=100\text{mA}, V_{CE}=1\text{V}$	100 100			
Collector-emitter saturation voltage	$V_{CE(sat)}$	$I_C=100\text{mA}, I_B=10\text{mA}$			0.25	V
Base-emitter on voltage	$V_{BE(on)}$	$I_C=100\text{mA}, V_{CE}=1\text{V}$			1.2	V
SMALL-SIGNAL CHARACTERISTICS						
Current gain bandwidth product (note 2)	f_T	MPSA06: $I_C=10\text{mA}, V_{CE}=2\text{V}, f=100\text{MHz}$ MPSA56: $I_C=100\text{mA}, V_{CE}=1\text{V}, f=100\text{MHz}$	100 50			MHz MHz

Note 1: Pulse test: $PW \leq 300\mu\text{s}$, Duty Cycle $\leq 2\%$

Note 2: f_T is defined as the frequency at which $|h_{fe}|$ extrapolates to unity.

SWITCHING TIME TEST CIRCUITS

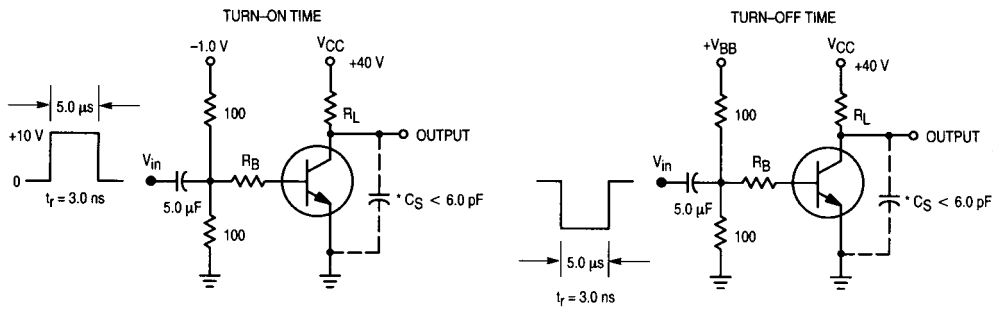

Figure 1

(Note: Total shunt capacitance of test jig and connectors for PNP test circuits, reverse all voltage polarities.)

MPSA06

MPSA56

CURRENT-GAIN BANDWIDTH PRODUCT

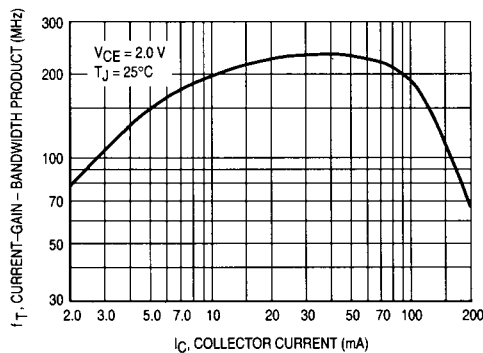

Figure 2

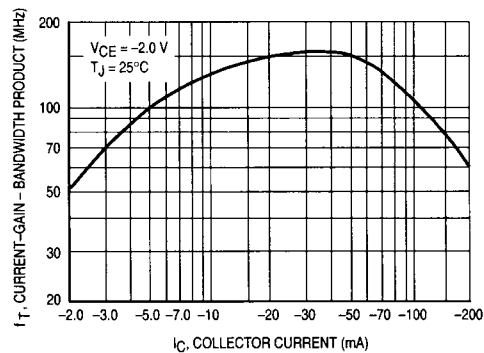

Figure 3

MPSA06

MPSA56

CAPACITANCE

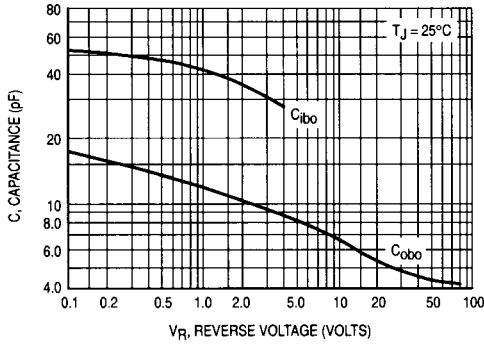

Figure 4

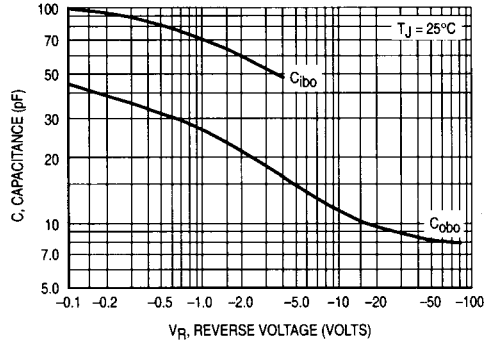

Figure 5

SWITCHING TIME

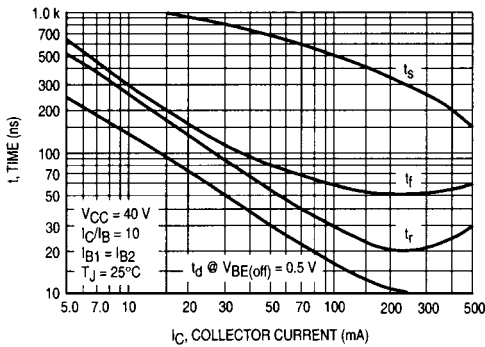

Figure 6

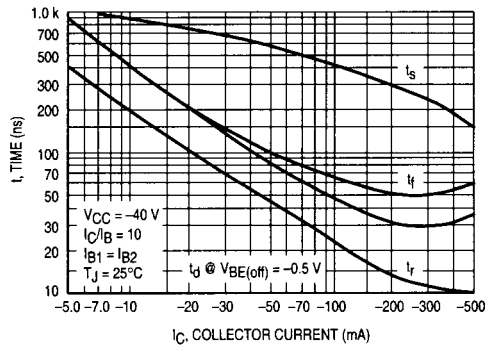

Figure 7

ACTIVE-REGION SAFE OPERATING AREA

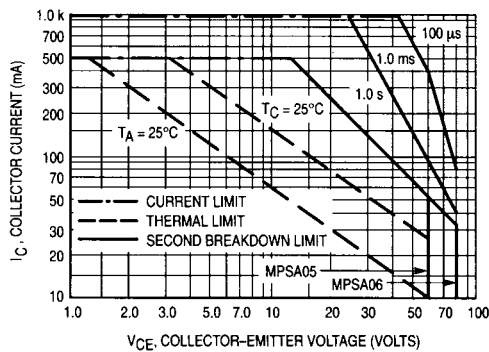

Figure 8

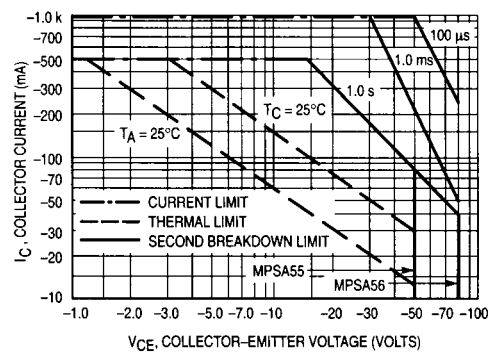

Figure 9

MPSA06

MPSA56

DC CURRENT GAIN

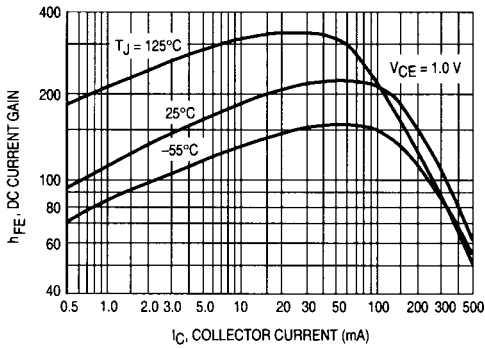

Figure 10

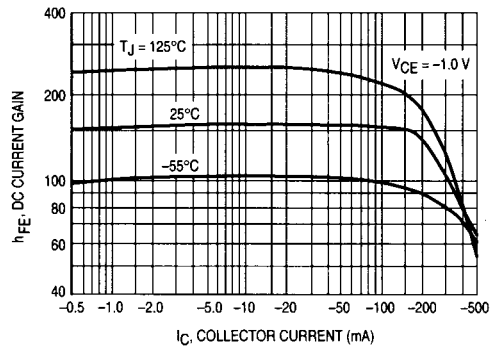

Figure 11

“ON” VOLTAGES

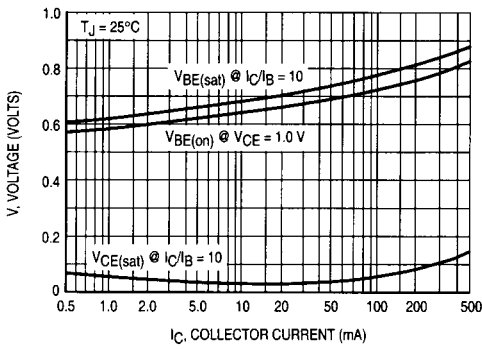

Figure 12

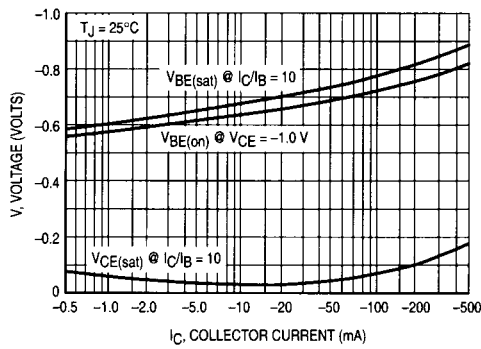

Figure 13

COLLECTOR SATURATION REGION

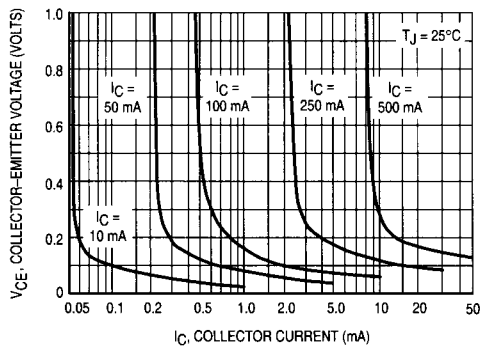

Figure 14

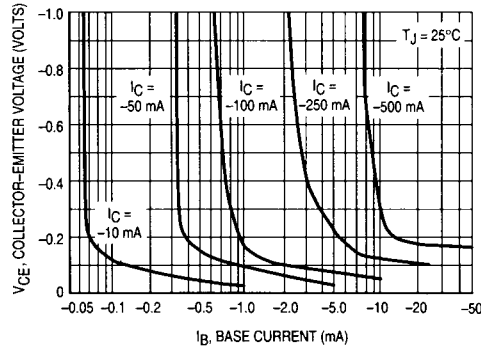

Figure 15

MPSA06

MPSA56

BASE-EMITTER TEMPERATURE COEFFICIENT

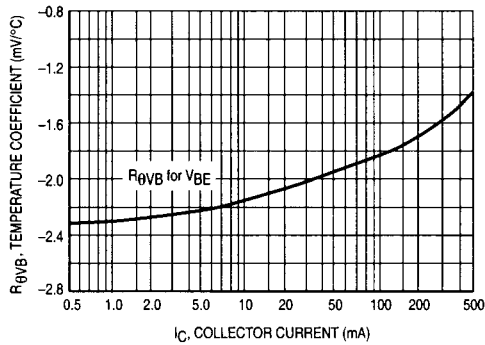

Figure 16

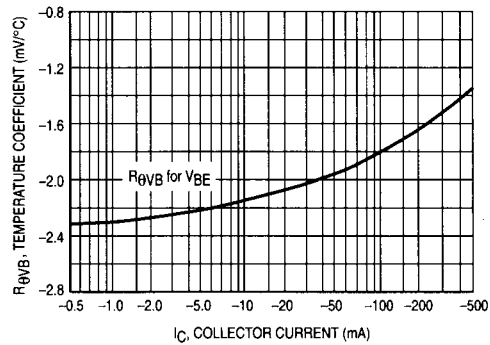

Figure 17

THERMAL RESPONSE

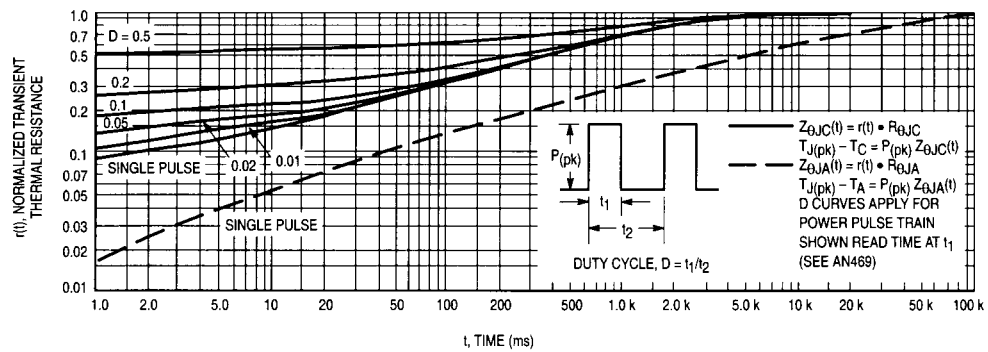

Figure 18

UTC assumes no responsibility for equipment failures that result from using products at values that exceed, even momentarily, rated values (such as maximum ratings, operating condition ranges, or other parameters) listed in products specifications of any and all UTC products described or contained herein. UTC products are not designed for use in life support appliances, devices or systems where malfunction of these products can be reasonably expected to result in personal injury. Reproduction in whole or in part is prohibited without the prior written consent of the copyright owner. The information presented in this document does not form part of any quotation or contract, is believed to be accurate and reliable and may be changed without notice.