

# FLM1011-15F

## X,Ku-Band Internally Matched FET

### FEATURES

- High Output Power: P1dB=42.0dBm(Typ.)
- High Gain: G1dB=7.0dB(Typ.)
- High PAE:  $\eta_{add}$ =31%(Typ.)
- Broad Band: 10.7~11.7GHz
- Impedance Matched Zin/Zout = 50 $\Omega$
- Hermetically Sealed Package



### DESCRIPTION

The FLM1011-15F is a power GaAs FET that is internally matched for standard communication bands to provide optimum power and gain in a 50 $\Omega$  system.

### ABSOLUTE MAXIMUM RATINGS (Case Temperature Tc=25°C)

Item	Symbol	Rating	Unit
Drain-Source Voltage	V <sub>DS</sub>	15	V
Gate-Source Voltage	V <sub>GS</sub>	-5	V
Total Power Dissipation	P <sub>T</sub>	57.7	W
Storage Temperature	T <sub>stg</sub>	-65 to +175	°C
Channel Temperature	T <sub>ch</sub>	175	°C

### RECOMMENDED OPERATING CONDITION (Case Temperature Tc=25°C)

Item	Symbol	Condition	Limit	Unit
DC Input Voltage	V <sub>DS</sub>		≤10	V
Forward Gate Current	I <sub>GF</sub>	R <sub>G</sub> =50 $\Omega$	≤16.7	mA
Reverse Gate Current	I <sub>GR</sub>	R <sub>G</sub> =50 $\Omega$	≥-3.62	mA

### ELECTRICAL CHARACTERISTICS (Case Temperature Tc=25°C)

Item	Symbol	Test Conditions	Limit			Unit
			Min.	Typ.	Max.	
Drain Current	I <sub>DSS</sub>	V <sub>DS</sub> =5V, V <sub>GS</sub> =0V	-	7.2	10.8	A
Transconductance	g <sub>m</sub>	V <sub>DS</sub> =5V, I <sub>DS</sub> =4.55A	-	4500	-	mS
Pinch-off Voltage	V <sub>p</sub>	V <sub>DS</sub> =5V, I <sub>DS</sub> =300mA	-0.5	-1.5	-3.0	V
Gate-Source Breakdown Voltage	V <sub>GSO</sub>	I <sub>GS</sub> =-300 $\mu$ A	-5.0	-	-	V
Output Power at 1dB G.C.P.	P <sub>1dB</sub>	V <sub>DS</sub> =10V f=10.7 - 11.7 GHz I <sub>DS</sub> =0.5I <sub>DSS</sub> (typ) Z <sub>S</sub> =Z <sub>L</sub> =50 $\Omega$	41.0	42.0	-	dBm
Power Gain at 1dB G.C.P.	G <sub>1dB</sub>		6.0	7.0	-	dB
Drain Current	I <sub>DSR</sub>		-	4.0	5.0	A
Power-added Efficiency	$\eta_{add}$		-	31	-	%
Gain Flatness	$\Delta$ G		-	-	1.2	dB
Thermal Resistance	R <sub>th</sub>		Channel to Case	-	2.3	2.6
Channel Temperature Rise	$\Delta$ T <sub>ch</sub>	10V x I <sub>DSR</sub> x R <sub>th</sub>	-	-	100	°C
3rd Order Intermodulation Distortion	IM <sub>3</sub>	f=11.7GHz, $\Delta$ f=10MHz, 2-Tone Test P <sub>out</sub> =30.0dBm S.C.L.	-42	-45	-	dBc

### CASE STYLE: IB

G.C.P.: Gain Compression Point, S.C.L.: Single Carrier Level

ESD	Class III	2000V ~
-----	-----------	---------

Note : Based on EIAJ ED-4701 C-111A(C=100pF, R=1.5k $\Omega$ )

# FLM1011-15F

X,Ku-Band Internally Matched FET

POWER DERATING CURVE

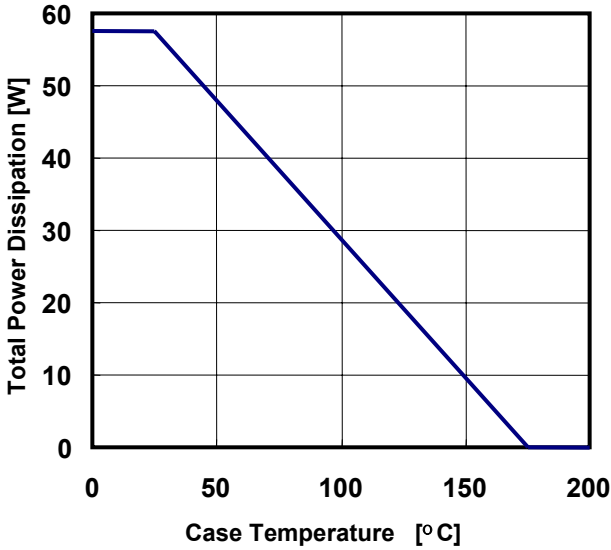

OUTPUT POWER , POWER ADDED EFFICIENCY v.s. INPUT POWER

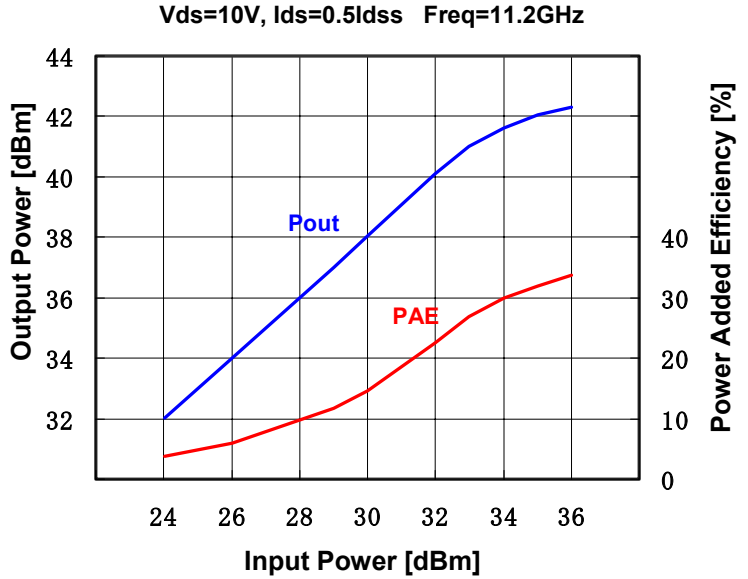

OUTPUT POWER v.s. FREQUENCY

Vds=10V, Ids=0.5Ids

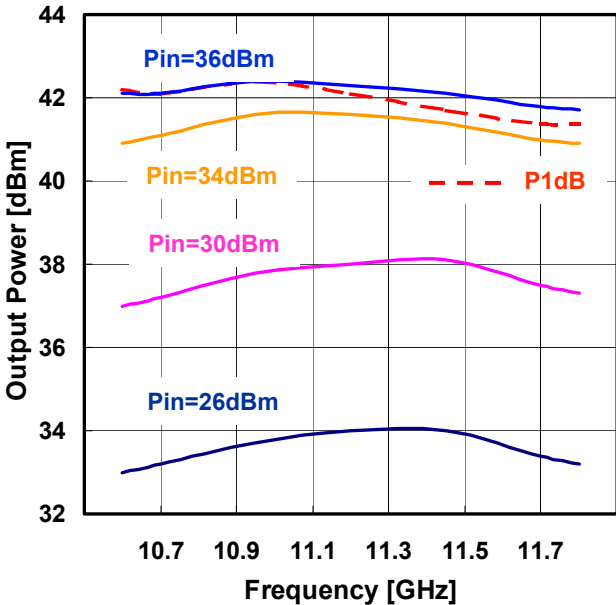

IMD v.s. OUTPUT POWER (S.C.L.)

Vds=10V, Ids=3.6A  
f1=11.70GHz, f2=11.71GHz, 2-tone test

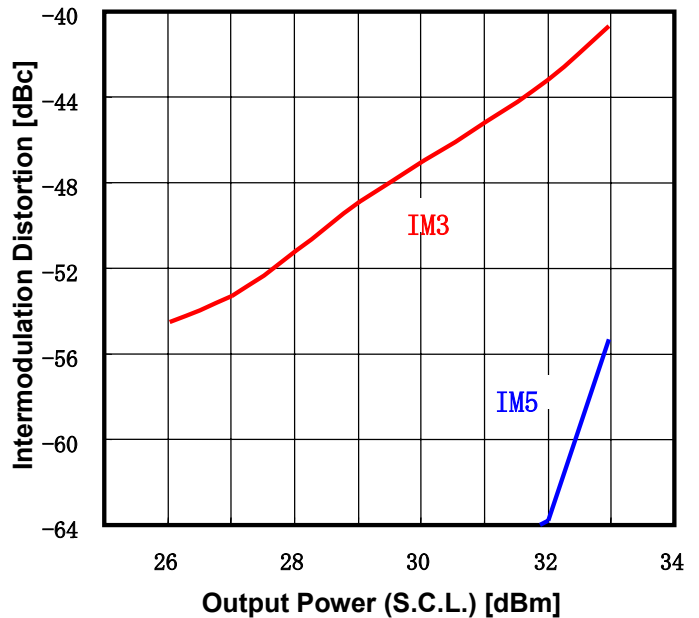

# FLM1011-15F

X,Ku-Band Internally Matched FET

## S-PARAMETERS

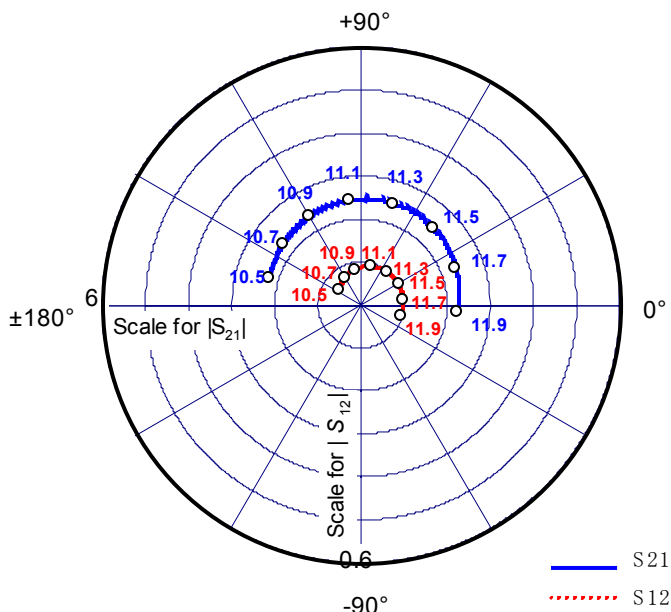
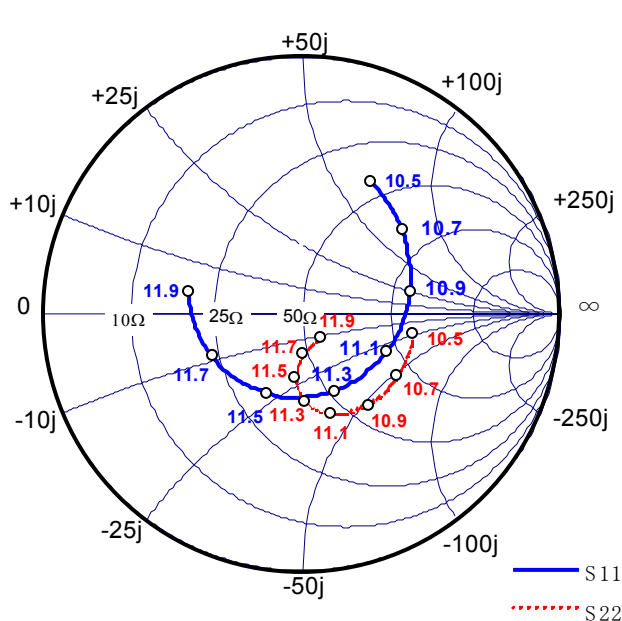

VDS=10V , IDS=0.5Idss

Freq. (GHz)	S11		S21		S12		S22	
	MAG	ANG	MAG	ANG	MAG	ANG	MAG	ANG
10.5	0.580	62.4	2.199	163.7	0.061	143.2	0.438	-10.3
10.6	0.543	51.5	2.241	152.6	0.067	131.7	0.439	-21.9
10.7	0.505	39.9	2.289	142.1	0.072	121.5	0.442	-33.2
10.8	0.465	26.8	2.328	131.0	0.078	109.7	0.446	-44.2
10.9	0.428	11.9	2.380	119.8	0.084	98.9	0.440	-54.3
11.0	0.389	-5.2	2.419	108.3	0.089	87.5	0.426	-64.2
11.1	0.359	-23.9	2.453	96.2	0.092	75.7	0.406	-73.5
11.2	0.334	-45.5	2.476	84.4	0.095	64.1	0.378	-81.8
11.3	0.325	-67.6	2.472	72.1	0.097	51.7	0.342	-88.4
11.4	0.325	-90.9	2.466	59.6	0.099	40.7	0.298	-93.3
11.5	0.338	-113.1	2.446	47.2	0.100	28.0	0.250	-95.3
11.6	0.359	-134.2	2.403	34.3	0.100	16.9	0.201	-95.0
11.7	0.383	-154.1	2.367	21.8	0.099	6.5	0.158	-88.3
11.8	0.415	-172.6	2.312	9.1	0.096	-4.4	0.128	-74.1
11.9	0.445	169.3	2.243	-4.3	0.095	-15.8	0.121	-52.5

# FLM1011-15F

X,Ku-Band Internally Matched FET

## ■ Package Out Line

Case Style : IB

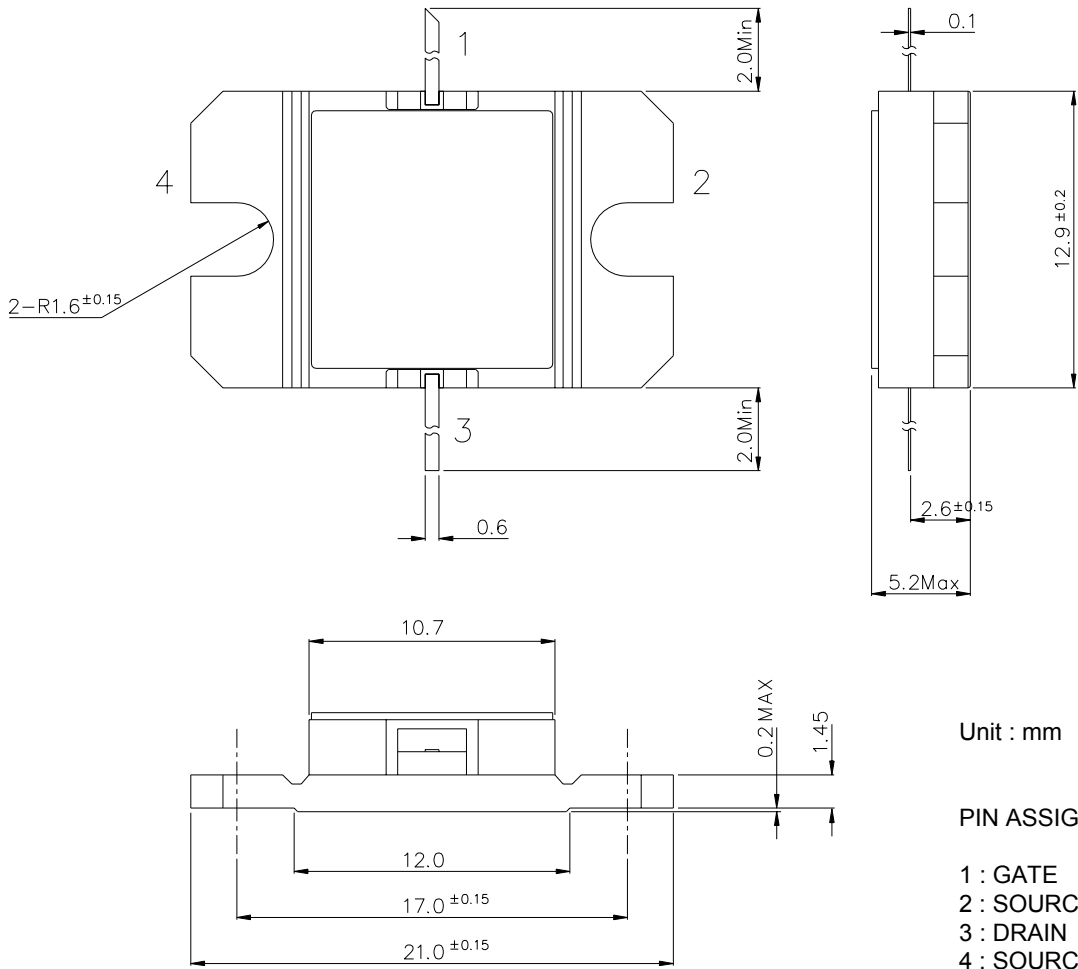

---

---

---

# FLM1011-15F

## X,Ku-Band Internally Matched FET

For further information please contact :

**Eudyna Devices USA Inc.**

2355 Zanker Rd.  
San Jose, CA 95131-1138, U.S.A.  
TEL: (408) 232-9500  
FAX: (408) 428-9111  
www.us.eudyna.com

**Eudyna Devices Europe Ltd.**

Network House  
Norreys Drive  
Maidenhead, Berkshire SL6 4FJ  
United Kingdom  
TEL: +44 (0) 1628 504800  
FAX: +44 (0) 1628 504888

**Eudyna Devices Asia Pte. Ltd.**

Hong Kong Branch  
Rm.1101,Ocean Centre, 5 Canton Road  
Tsim Sha Tsui, Kowloon, Hong Kong  
TEL: +852-2377-0227  
FAX: +852-2377-3921

**Eudyna Devices Inc.**

1000 Kamisukiahara, showa-cho  
Nakakomagun, Yamanashi  
409-3883, Japan  
(Kokubo Industrial Park)  
TEL +81-55-275-4411  
FAX +81-55-275-9461

**Sales Division**

1, Kanai-cho, Sakae-ku  
Yokohama,244-0845,Japan  
TEL +81-45-853-8156  
FAX +81-45-853-8170

**CAUTION**

Eudyna Devices Inc. products contain **gallium arsenide (GaAs)** which can be hazardous to the human body and the environment. For safety, observe the following procedures:

- Do not put these products into the mouth.
- Do not alter the form of this product into a gas, powder, or liquid through burning, crushing, or chemical processing as these by-products are dangerous to the human body if inhaled, ingested, or swallowed.
- Observe government laws and company regulations when discarding this product. This product must be discarded in accordance with methods specified by applicable hazardous waste procedures.

Eudyna Devices Inc. reserves the right to change products and specifications without notice. The information does not convey any license under rights of Eudyna Devices Inc. or others.

© 2004 Eudyna Devices USA Inc.  
Printed in U.S.A.

---

