

DATA SHEET

BFG11; BFG11/X NPN 2 GHz RF power transistor

Product specification
Supersedes data of November 1992
File under Discrete Semiconductors, SC14

1995 Apr 07

Philips Semiconductors



PHILIPS

NPN 2 GHz RF power transistor

BFG11; BFG11/X

FEATURES

- High power gain
- High efficiency
- Small size discrete power amplifier
- 1.9 GHz operating area
- Gold metallization ensures excellent reliability.

APPLICATIONS

- Common emitter class-AB operation in hand-held radio equipment at 1.9 GHz.

PINNING

PIN	DESCRIPTION
BFG11 (see Fig.1)	
1	collector
2	base
3	emitter
4	emitter
BFG11/X (see Fig.1)	
1	collector
2	emitter
3	base
4	emitter

DESCRIPTION

NPN silicon planar epitaxial transistors encapsulated in a plastic, 4-pin dual-emitter SOT143 package.

MARKING

TYPE NUMBER	CODE
BFG11	N72
BFG11/X	N73

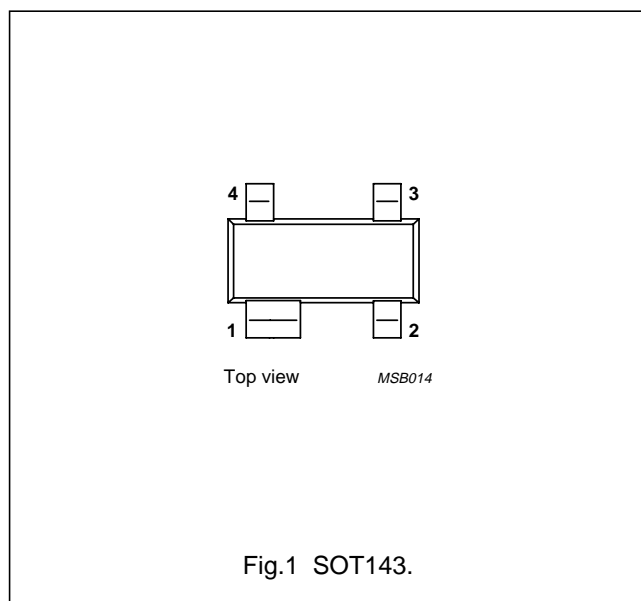

QUICK REFERENCE DATA

RF performance at $T_{amb} = 25\text{ }^{\circ}\text{C}$ in a common-emitter test circuit (see Fig.7).

MODE OF OPERATION	f (GHz)	V_{CE} (V)	P_L (mW)	G_p (dB)	η_c (%)
Pulsed, class-AB, duty cycle < 1 : 8	1.9	3.6	400	≥ 4	≥ 50

NPN 2 GHz RF power transistor

BFG11; BFG11/X

LIMITING VALUES

In accordance with the Absolute Maximum Rating System (IEC 134).

SYMBOL	PARAMETER	CONDITIONS	MIN.	MAX.	UNIT
V _{CBO}	collector-base voltage	open emitter	–	20	V
V _{CEO}	collector-emitter voltage	open base	–	8	V
V _{EBO}	emitter-base voltage	open collector	–	2.5	V
I _C	collector current (DC)		–	500	mA
I _{C(AV)}	average collector current		–	500	mA
P _{tot}	total power dissipation	up to T _s = 60 °C; note 1; see Fig.2	–	400	mW
T _{stg}	storage temperature		–65	+150	°C
T _j	junction temperature		–	175	°C

THERMAL CHARACTERISTICS

SYMBOL	PARAMETER	CONDITIONS	VALUE	UNIT
R _{th j-s}	thermal resistance from junction to soldering point	up to T _s = 60 °C; note 1; P _{tot} = 400 mW	290	K/W

Note to the “Limiting values” and “Thermal characteristics”

1. T_s is the temperature at the soldering point of the collector pin.

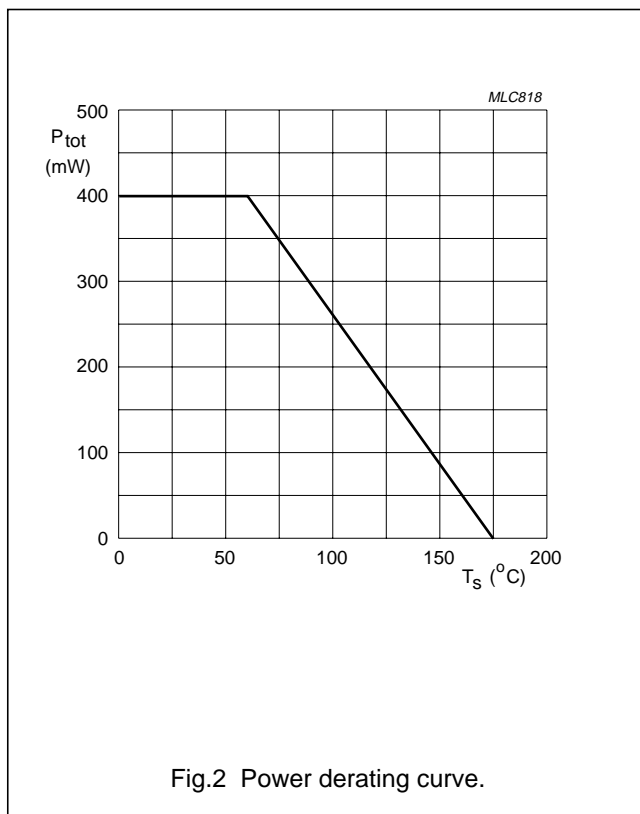

NPN 2 GHz RF power transistor

BFG11; BFG11/X

CHARACTERISTICS

$T_j = 25\text{ }^\circ\text{C}$ unless otherwise specified.

SYMBOL	PARAMETER	CONDITIONS	MIN.	MAX.	UNIT
$V_{(BR)CBO}$	collector-base breakdown voltage	open emitter; $I_C = 0.1\text{ mA}$; $I_E = 0$	20	–	V
$V_{(BR)CEO}$	collector-emitter breakdown voltage	open base; $I_C = 10\text{ mA}$; $I_B = 0$	8	–	V
$V_{(BR)EBO}$	emitter-base breakdown voltage	open collector; $I_E = 0.1\text{ mA}$; $I_C = 0$	2.5	–	V
I_{CES}	collector cut-off current	$V_{CE} = 8\text{ V}$; $V_{BE} = 0$	–	100	μA
h_{FE}	DC current gain	$I_C = 100\text{ mA}$; $V_{CE} = 5\text{ V}$	25	–	
C_c	collector capacitance	$I_E = i_e = 0$; $V_{CB} = 3.6\text{ V}$; $f = 1\text{ MHz}$	–	4	pF
C_{re}	feedback capacitance	$I_C = 0$; $V_{CE} = 3.6\text{ V}$; $f = 1\text{ MHz}$	–	3	pF

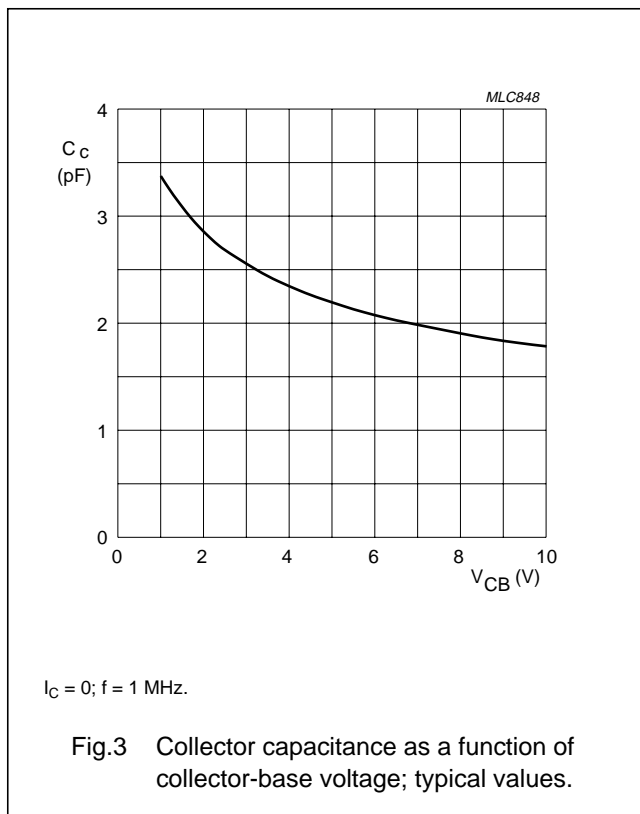

NPN 2 GHz RF power transistor

BFG11; BFG11/X

APPLICATION INFORMATION

RF performance at $T_{amb} = 25\text{ }^{\circ}\text{C}$ in a common-emitter test circuit (see Fig.7).

MODE OF OPERATION	f (GHz)	V _{CE} (V)	I _{CQ} (mA)	P _L (mW)	G _p (dB)	η_c (%)
Pulsed, class-AB, duty cycle < 1 : 8	1.9	3.6	1	400	≥ 4 typ. 5	≥ 50 typ. 70

Ruggedness in class-AB operation

The BFG11 is capable of withstanding a load mismatch corresponding to VSWR = 8 : 1 through all phases, at rated output power under pulsed conditions up to a supply voltage of 8 V, f = 1.9 GHz and a duty cycle of 1 : 8.

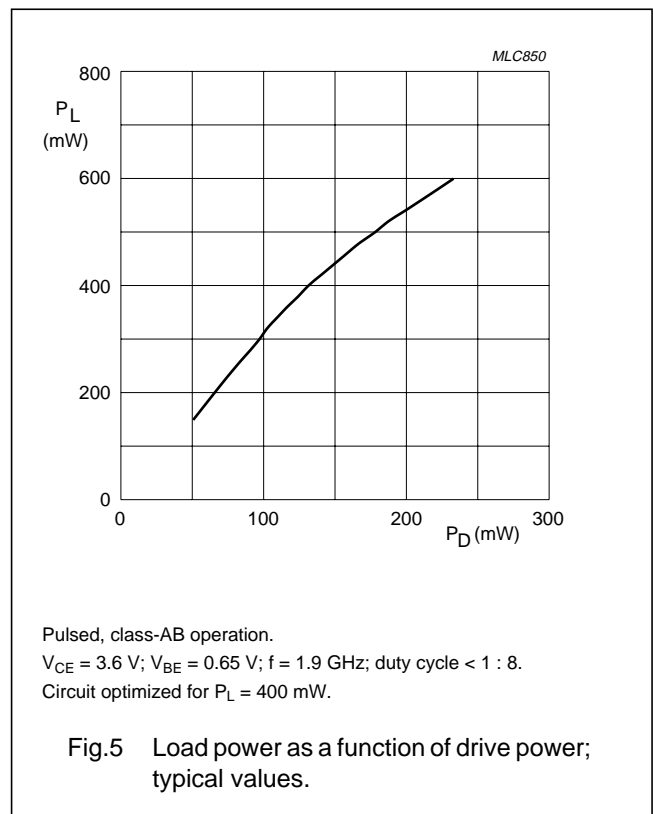
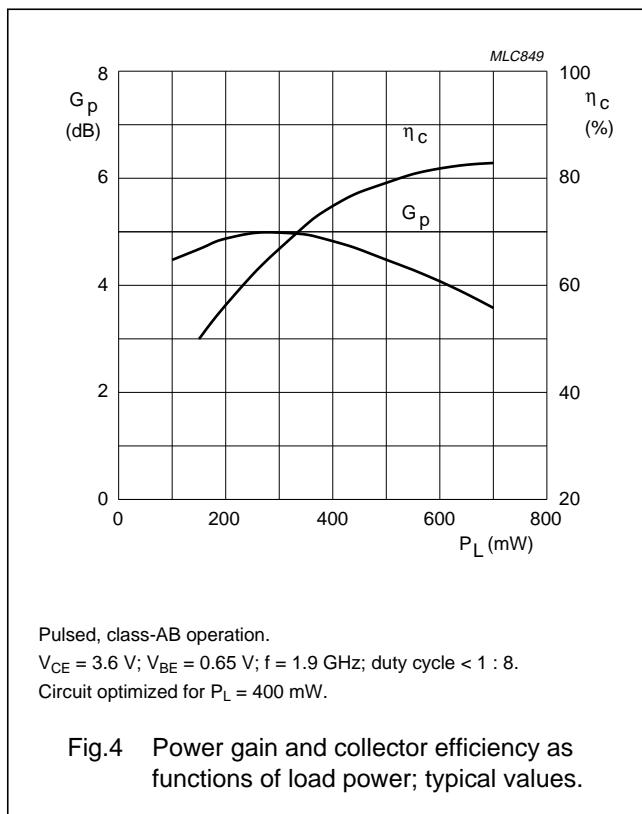

NPN 2 GHz RF power transistor

BFG11; BFG11/X

SPICE parameters for the BFG11 crystal

SEQUENCE No.	PARAMETER	VALUE	UNIT
1	IS	3.338	fA
2	BF	97.14	–
3	NF	0.988	–
4	VAF	31.40	V
5	IKF	51.45	A
6	ISE	23.53	pA
7	NE	2.386	–
8	BR	13.73	–
9	NR	0.989	–
10	VAR	2.448	V
11	IKR	100.0	A
12	ISC	54.10	fA
13	NC	1.224	–
14	RB	1.740	Ω
15	IRB	1.000	μA
16	RBM	1.740	Ω
17	RE	59.65	mΩ
18	RC	0.124	Ω
19 ⁽¹⁾	XTB	0.000	–
20 ⁽¹⁾	EG	1.110	eV
21 ⁽¹⁾	XTI	3.000	–
22	CJE	9.555	pF
23	VJE	0.600	V
24	MJE	0.315	–
25	TF	12.96	ps
26	XTF	400.0	–
27	VTF	0.866	V
28	ITF	5.940	A
29	PTF	0.000	deg
30	CJC	4.274	pF
31	VJC	0.650	V
32	MJC	0.392	–
33	XCJC	0.150	–
34 ⁽¹⁾	TR	0.000	ns
35 ⁽¹⁾	CJS	0.000	F

SEQUENCE No.	PARAMETER	VALUE	UNIT
36 ⁽¹⁾	VJS	750.0	mV
37 ⁽¹⁾	MJS	0.000	–
38	FC	0.742	–

Note

1. These parameters have not been extracted, the default values are shown.

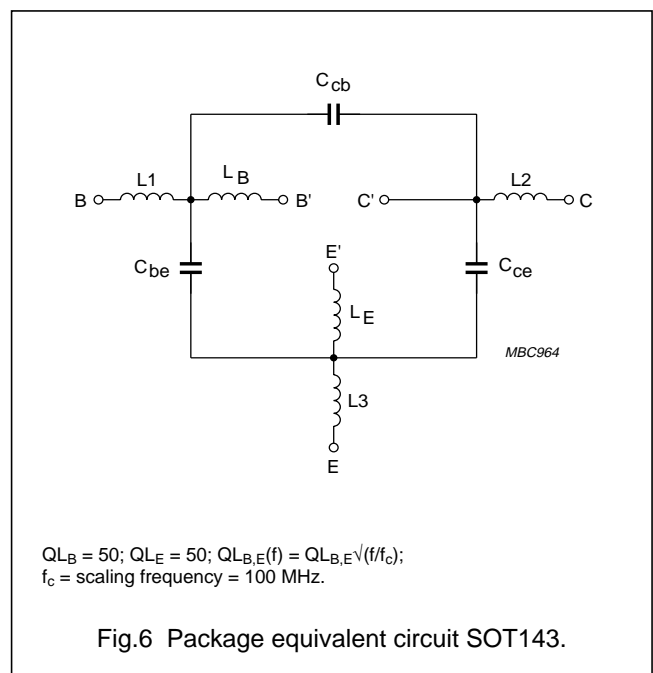

List of components (see Fig.6)

DESIGNATION	VALUE	UNIT
C _{be}	84	fF
C _{cb}	17	fF
C _{ce}	191	fF
L1	0.12	nH
L2	0.21	nH
L3	0.06	nH
L _B	0.95	nH
L _E	0.40	nH

NPN 2 GHz RF power transistor

BFG11; BFG11/X

Test circuit information

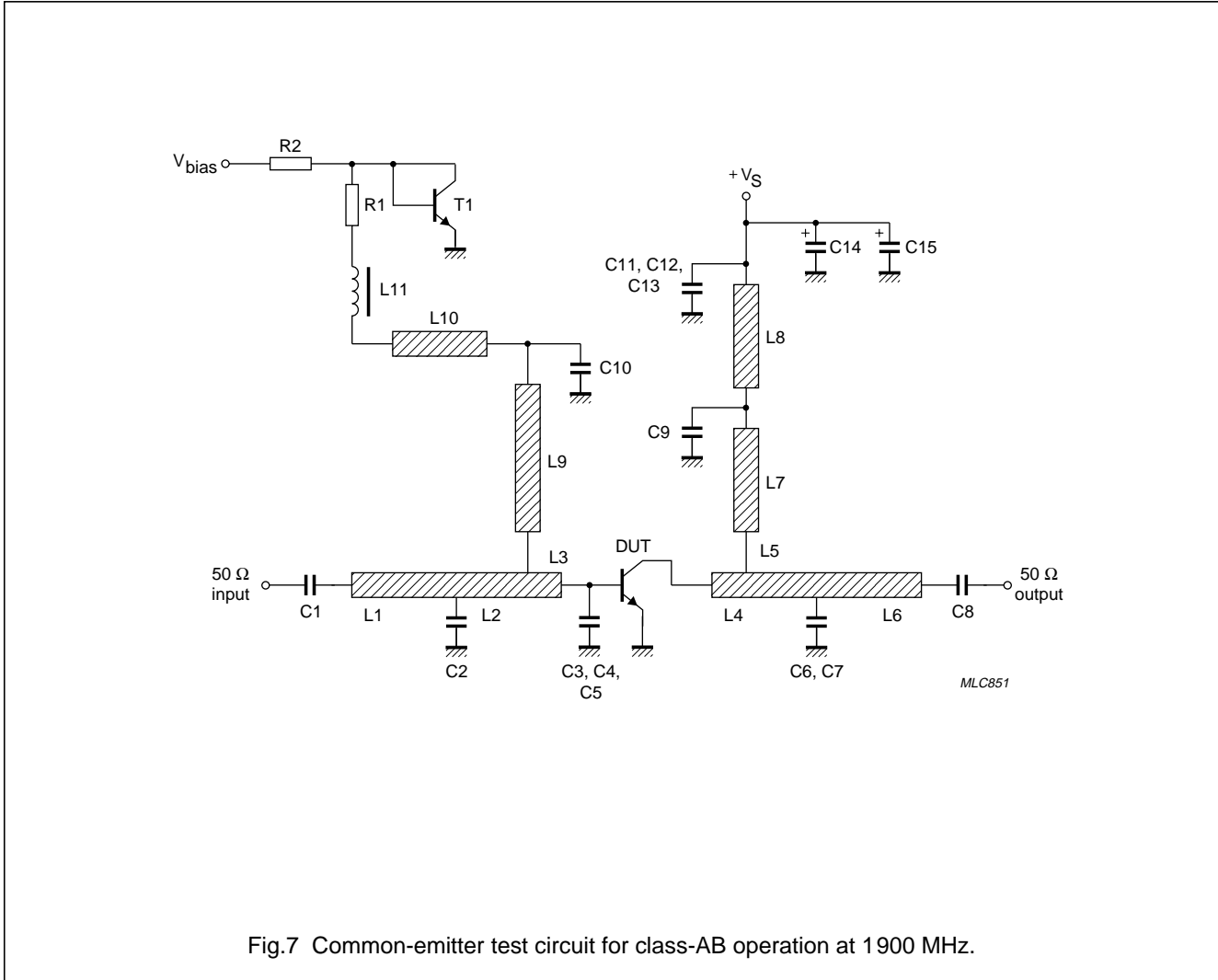

Fig.7 Common-emitter test circuit for class-AB operation at 1900 MHz.

NPN 2 GHz RF power transistor

BFG11; BFG11/X

List of components used in test circuit (see Fig.8)

COMPONENT	DESCRIPTION	VALUE	DIMENSIONS	CATALOGUE NO.
C1, C8, C9, C10	multilayer ceramic chip capacitor; note 1	24 pF		
C2	multilayer ceramic chip capacitor; note 1	0.4 pF		
C3	multilayer ceramic chip capacitor; note 1	0.6 pF		
C4, C7	multilayer ceramic chip capacitor; note 1	1 pF		
C5, C6,	multilayer ceramic chip capacitor; note 1	1.5 pF		
C11, C12,C13	multilayer ceramic chip capacitor; note 1	10 nF		
C14, C15	electrolytic capacitor	10 V; 470 μ F		2222 031 34471
L1	stripline; note 2		length 4 mm width 0.93 mm	
L2	stripline; note 2		length 26 mm width 0.93 mm	
L3	stripline; note 2		length 1.9 mm width 0.93 mm	
L4	stripline; note 2		length 3.1 mm width 0.93 mm	
L5	stripline; note 2		length 1.8 mm width 0.93 mm	
L6	stripline; note 2		length 26.4 mm width 0.93 mm	
L7	stripline; note 2		length 10 mm width 0.93 mm	
L8	stripline; note 2		length 4.4 mm width 0.4 mm	
L9	stripline; note 2		length 19.3 mm width 0.93 mm	
L10	stripline; note 2		length 19.7 mm width 0.4 mm	
L11	micro choke			
T1	BD228			
R1	metal film resistor	20 Ω ; 0.4 W		2322 157 10209
R2	metal film resistor	265 Ω ; 0.4 W		2322 157 12651

Notes

1. American Technical Ceramics (ATC) capacitor, type 100A or other capacitor of the same quality.
2. The striplines are on a $\frac{1}{32}$ inch double copper-clad printed-circuit board with PTFE fibre-glass dielectric ($\epsilon_r = 6$).

NPN 2 GHz RF power transistor

BFG11; BFG11/X

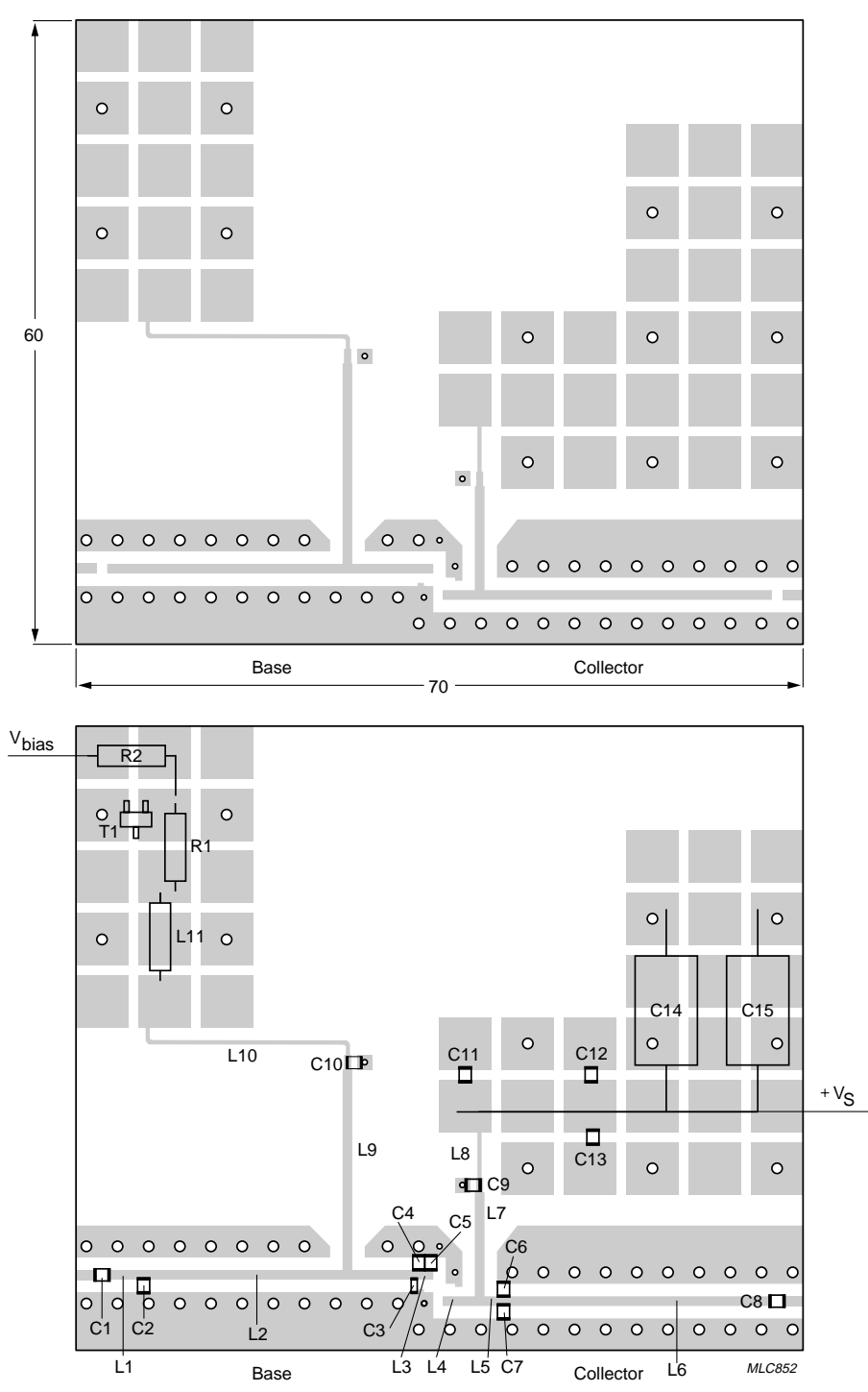

Dimensions in mm.

The components are situated on one side of the copper-clad PTFE microfibre-glass board, the other side is not etched and serves as a ground plane. Earth connections from the component side to the ground plane are made by through metallization.

Fig.8 Printed-circuit board and component lay-out for common-emitter test circuit in Fig.7.

NPN 2 GHz RF power transistor

BFG11; BFG11/X

PACKAGE OUTLINE

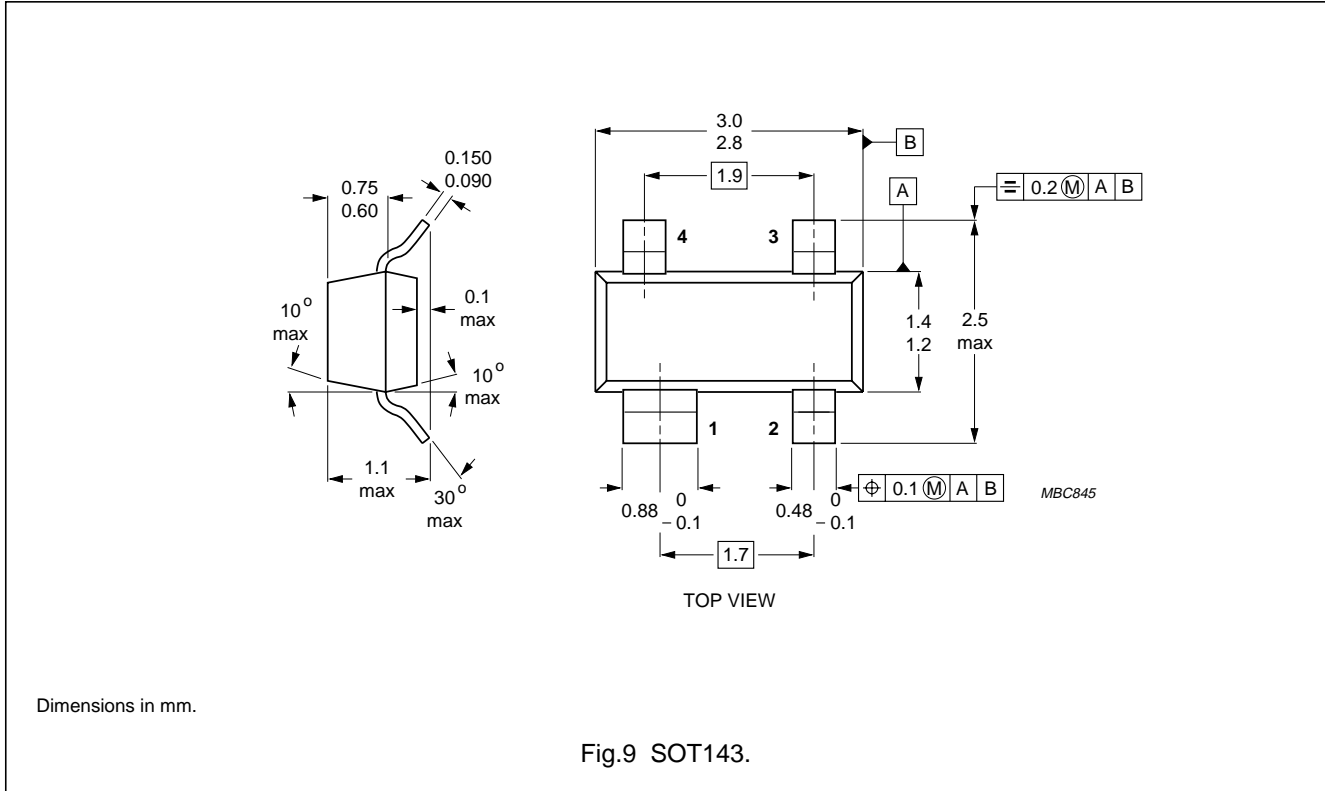

DEFINITIONS

Data Sheet Status	
Objective specification	This data sheet contains target or goal specifications for product development.
Preliminary specification	This data sheet contains preliminary data; supplementary data may be published later.
Product specification	This data sheet contains final product specifications.
Limiting values	
Limiting values given are in accordance with the Absolute Maximum Rating System (IEC 134). Stress above one or more of the limiting values may cause permanent damage to the device. These are stress ratings only and operation of the device at these or at any other conditions above those given in the Characteristics sections of the specification is not implied. Exposure to limiting values for extended periods may affect device reliability.	
Application information	
Where application information is given, it is advisory and does not form part of the specification.	

LIFE SUPPORT APPLICATIONS

These products are not designed for use in life support appliances, devices, or systems where malfunction of these products can reasonably be expected to result in personal injury. Philips customers using or selling these products for use in such applications do so at their own risk and agree to fully indemnify Philips for any damages resulting from such improper use or sale.

NPN 2 GHz RF power transistor

BFG11; BFG11/X

NOTES

Philips Semiconductors – a worldwide company

Argentina: IEROD, Av. Juramento 1992 - 14.b, (1428)
BUENOS AIRES, Tel. (541)786 7633, Fax. (541)786 9367

Australia: 34 Waterloo Road, NORTH RYDE, NSW 2113,
Tel. (02)805 4455, Fax. (02)805 4466

Austria: Triester Str. 64, A-1101 WIEN, P.O. Box 213,
Tel. (01)60 101-1236, Fax. (01)60 101-1211

Belgium: Postbus 90050, 5600 PB EINDHOVEN, The Netherlands,
Tel. (31)40 783 749, Fax. (31)40 788 399

Brazil: Rua do Rocio 220 - 5th floor, Suite 51,
CEP: 04552-903-SÃO PAULO-SP, Brazil.
P.O. Box 7383 (01064-970).

Tel. (011)821-2333, Fax. (011)829-1849

Canada: PHILIPS SEMICONDUCTORS/COMPONENTS:
Tel. (800) 234-7381, Fax. (708) 296-8556

Chile: Av. Santa Maria 0760, SANTIAGO,
Tel. (02)773 816, Fax. (02)777 6730

Colombia: IPRELENZO LTDA, Carrera 21 No. 56-17,
77621 BOGOTA, Tel. (571)249 7624/(571)217 4609,
Fax. (571)217 4549

Denmark: Prags Boulevard 80, PB 1919, DK-2300 COPENHAGEN S,
Tel. (032)88 2636, Fax. (031)57 1949

Finland: Sinikalliontie 3, FIN-02630 ESPOO,
Tel. (9)0-50261, Fax. (9)0-520971

France: 4 Rue du Port-aux-Vins, BP317,
92156 SURESNES Cedex,
Tel. (01)4099 6161, Fax. (01)4099 6427

Germany: P.O. Box 10 63 23, 20043 HAMBURG,
Tel. (040)3296-0, Fax. (040)3296 213.

Greece: No. 15, 25th March Street, GR 17778 TAVROS,
Tel. (01)4894 339/4894 911, Fax. (01)4814 240

Hong Kong: PHILIPS HONG KONG Ltd., 15/F Philips Ind. Bldg.,
24-28 Kung Yip St., KWAI CHUNG, N.T.,
Tel. (852)424 5121, Fax. (852)480 6960/480 6009

India: Philips INDIA Ltd, Shivsagar Estate, A Block,
Dr. Annie Besant Rd. Worli, Bombay 400 018
Tel. (022)4938 541, Fax. (022)4938 722

Indonesia: Philips House, Jalan H.R. Rasuna Said Kav. 3-4,
P.O. Box 4252, JAKARTA 12950,
Tel. (021)5201 122, Fax. (021)5205 189

Ireland: Newstead, Clonskeagh, DUBLIN 14,
Tel. (01)640 000, Fax. (01)640 200

Italy: PHILIPS SEMICONDUCTORS S.r.l.,
Piazza IV Novembre 3, 20124 MILANO,
Tel. (0039)2 6752 2531, Fax. (0039)2 6752 2557

Japan: Philips Bldg 13-37, Kohnan2-chome, Minato-ku, TOKYO 108,
Tel. (03)3740 5028, Fax. (03)3740 0580

Korea: (Republic of) Philips House, 260-199 Itaewon-dong,
Yongsan-ku, SEOUL, Tel. (02)794-5011, Fax. (02)798-8022

Malaysia: No. 76 Jalan Universiti, 46200 PETALING JAYA,
SELANGOR, Tel. (03)750 5214, Fax. (03)757 4880

Mexico: 5900 Gateway East, Suite 200, EL PASO, TX 79905,
Tel. 9-5(800)234-7381, Fax. (708)296-8556

Netherlands: Postbus 90050, 5600 PB EINDHOVEN, Bldg. VB
Tel. (040)783749, Fax. (040)788399

New Zealand: 2 Wagener Place, C.P.O. Box 1041, AUCKLAND,
Tel. (09)849-4160, Fax. (09)849-7811

Norway: Box 1, Manglerud 0612, OSLO,
Tel. (022)74 8000, Fax. (022)74 8341

Pakistan: Philips Electrical Industries of Pakistan Ltd.,
Exchange Bldg. ST-2/A, Block 9, KDA Scheme 5, Clifton,
KARACHI 75600, Tel. (021)587 4641-49,
Fax. (021)577035/5874546.

Philippines: PHILIPS SEMICONDUCTORS PHILIPPINES Inc,
106 Valero St. Salcedo Village, P.O. Box 2108 MCC, MAKATI,
Metro MANILA, Tel. (02)810 0161, Fax. (02)817 3474

Portugal: PHILIPS PORTUGUESA, S.A.,
Rua dr. António Loureiro Borges 5, Arquiparque - Miraflores,
Apartado 300, 2795 LINDA-A-VELHA,
Tel. (01)4163160/4163333, Fax. (01)4163174/4163366.

Singapore: Lorong 1, Toa Payoh, SINGAPORE 1231,
Tel. (65)350 2000, Fax. (65)251 6500

South Africa: S.A. PHILIPS Pty Ltd.,
195-215 Main Road Martindale, 2092 JOHANNESBURG,
P.O. Box 7430 Johannesburg 2000,
Tel. (011)470-5911, Fax. (011)470-5494.

Spain: Balmes 22, 08007 BARCELONA,
Tel. (03)301 6312, Fax. (03)301 42 43

Sweden: Kottbygatan 7, Akalla. S-164 85 STOCKHOLM,
Tel. (0)8-632 2000, Fax. (0)8-632 2745

Switzerland: Allmendstrasse 140, CH-8027 ZÜRICH,
Tel. (01)488 2211, Fax. (01)481 77 30

Taiwan: PHILIPS TAIWAN Ltd., 23-30F, 66, Chung Hsiao West
Road, Sec. 1, Taipei, Taiwan ROC, P.O. Box 22978,
TAIPEI 100, Tel. (02)388 7666, Fax. (02)382 4382.

Thailand: PHILIPS ELECTRONICS (THAILAND) Ltd.,
209/2 Sanpavuth-Bangna Road Prakanong,
Bangkok 10260, THAILAND,
Tel. (662)398-0141, Fax. (662)398-3319.

Turkey: Talatpasa Cad. No. 5, 80640 GÜLTEPE/ISTANBUL,
Tel. (0212)279 2770, Fax. (0212)282 6707

United Kingdom: Philips Semiconductors LTD.,
276 Bath Road, Hayes, MIDDLESEX UB3 5BX,
Tel. (0181)730-5000, Fax. (0181)754-8421

United States: 811 East Arques Avenue, SUNNYVALE,
CA 94088-3409, Tel. (800)234-7381, Fax. (708)296-8556

Uruguay: Coronel Mora 433, MONTEVIDEO,
Tel. (02)70-4044, Fax. (02)92 0601

Internet: <http://www.semiconductors.philips.com/ps/>

For all other countries apply to: Philips Semiconductors,
International Marketing and Sales, Building BE-p,
P.O. Box 218, 5600 MD, EINDHOVEN, The Netherlands,
Telex 35000 phtcnl, Fax. +31-40-724825

SCD38 © Philips Electronics N.V. 1995

All rights are reserved. Reproduction in whole or in part is prohibited without the prior written consent of the copyright owner.

The information presented in this document does not form part of any quotation or contract, is believed to be accurate and reliable and may be changed without notice. No liability will be accepted by the publisher for any consequence of its use. Publication thereof does not convey nor imply any license under patent- or other industrial or intellectual property rights.

Printed in The Netherlands

123055/1500/03/pp12
Document order number:

Date of release: 1995 Apr 07
9397 750 00017

Philips Semiconductors



PHILIPS