

UTC BF422

NPN EPITAXIAL SILICON TRANSISTOR

HIGH VOLTAGE TRANSISTOR

FEATURES

- *Collector-Emitter Voltage: $V_{CE0}=250V$.
- *Complementary to BF423.

APPLICATIONS

- * High voltage application.
- * Monitor equipment application.

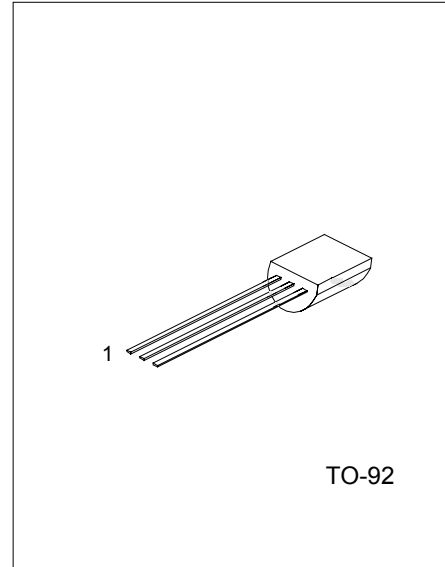

1: EMITTER 2: COLLECTOR 3: BASE

ABSOLUTE MAXIMUM RATINGS ($T_a=25^{\circ}C$)

PARAMETERS	SYMBOL	RATINGS	UNIT
Collector-Base Voltage	V_{CB0}	250	V
Collector-Emitter Voltage	V_{CE0}	250	V
Emitter-base voltage	V_{EB0}	5	V
Collector current (DC)	I_c	50	mA
collector current (Peak)	I_{cP}	100	mA
base current	I_b	50	mA
Collector Power dissipation	P_c	625	mW
Junction temperature	T_j	150	$^{\circ}C$
Storage Temperature	T_{stg}	-65~+150	$^{\circ}C$

ELECTRICAL CHARACTERISTICS ($T_a=25^{\circ}C$, unless otherwise specified)

PARAMETERS	SYMBOL	CONDITIONS	MIN.	TYP.	MAX.	UNIT
Collector Cut-Off Current	I_{CBO}	$V_{CB}=200V, I_E=0$			10	nA
		$V_{CB}=-200V, I_E=0, T_j=150^{\circ}C$			10	μA
Emitter Cut-Off Current	I_{EBO}	$V_{EB}=5V, I_c=0$			50	nA
DC current gain	h_{FE}	$V_{CE}=20V, I_c=25mA$	50			
Collector-Emitter Saturation Voltage	$V_{CE(sat)}$	$I_c=30mA, I_b=5mA$			0.6	V
Base-Emitter Voltage	V_{BE}	$V_{CE}=-20V, I_c=25mA$		0.75		V
Transition frequency	f_T	$V_{CE}=10V, I_c=10mA$	60			MHz
Reverse Transfer Capacitance	C_{re}	$V_{CB}=30V, I_E=0, f=1MHz$			1.6	pF

TYPICAL CHARACTERISTICS

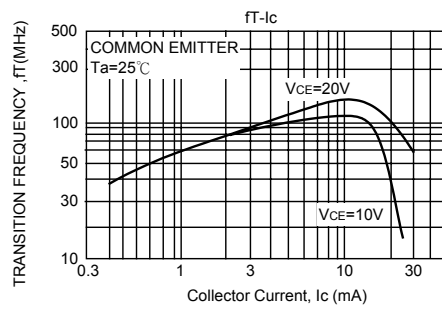
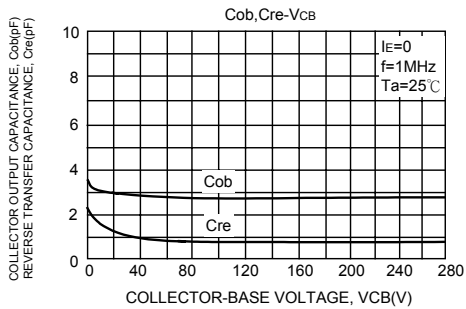
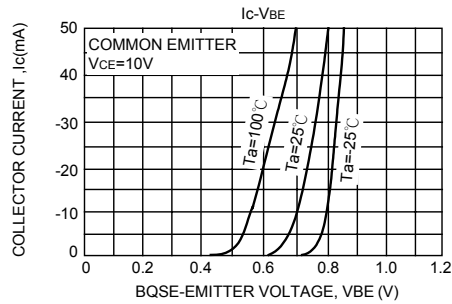
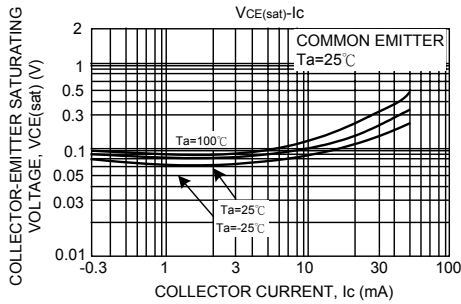
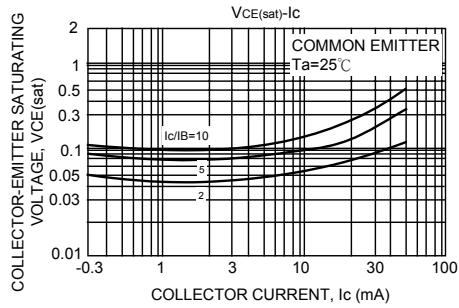
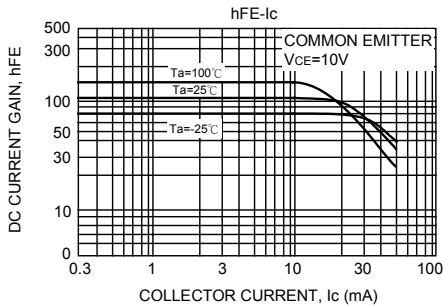
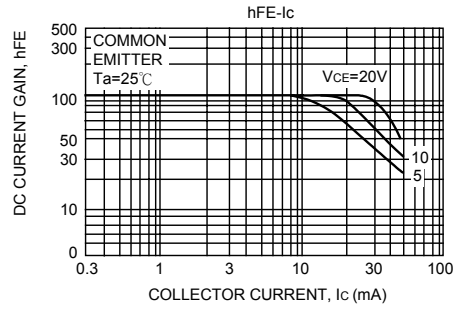
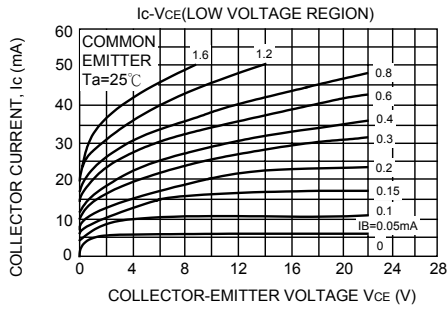

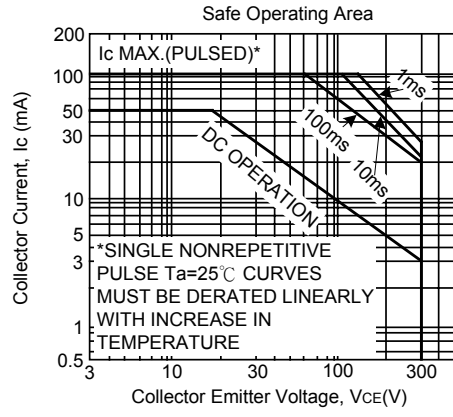
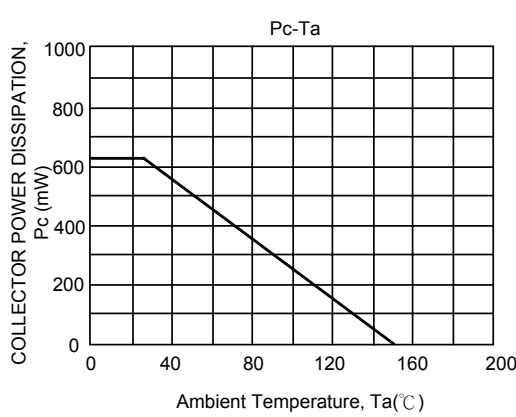

UTC assumes no responsibility for equipment failures that result from using products at values that exceed, even momentarily, rated values (such as maximum ratings, operating condition ranges, or other parameters) listed in products specifications of any and all UTC products described or contained herein. UTC products are not designed for use in life support appliances, devices or systems where malfunction of these products can be reasonably expected to result in personal injury. Reproduction in whole or in part is prohibited without the prior written consent of the copyright owner. The information presented in this document does not form part of any quotation or contract, is believed to be accurate and reliable and may be changed without notice.