

HIGH FREQUENCY LOW NOISE
AMPLIFIER

FEATURES

- *Low Noise and High Gain
- *High Power Gain

MARKING

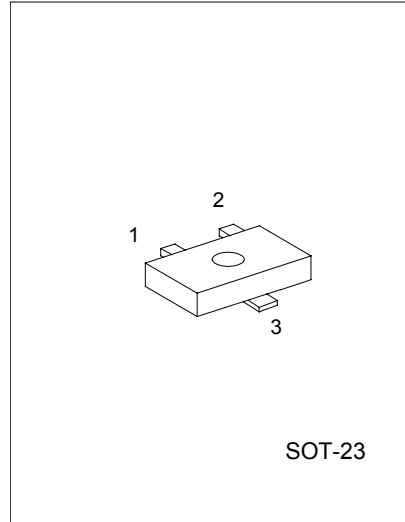
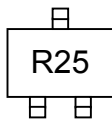

SOT-23

1: EMITTER 2: BASE 3: COLLECTOR

ABSOLUTE MAXIMUM RATINGS (T_A=25°C, unless otherwise specified)

PARAMETER	SYMBOL	RATING	UNIT
Collector-base voltage	V _{CB0}	20	V
Collector-emitter voltage	V _{CEO}	12	V
Emitter-base voltage	V _{EB0}	3	V
Collector current	I _C	100	mA
Total power dissipation	P _T	200	mW
Junction Temperature	T _j	150	°C
Storage Temperature	T _{stg}	-65 ~ +150	°C

ELECTRICAL CHARACTERISTICS (T_a=25°C, unless otherwise specified)

PARAMETER	SYMBOL	TEST CONDITIONS	MIN	TYP	MAX	UNIT
Collector Cutoff Current	I _{CB0}	V _{CB} =10V, I _E =0			1.0	μA
Emitter Cutoff Current	I _{EB0}	V _{EB} =1V, I _C =0			1.0	μA
DC Current Gain	h _{FE}	V _{CE} =10V, I _C =20mA	50		300	
Gain bandwidth Product	f _T	V _{CE} =10V, I _C =20mA		7		GHz
Feed-Back Capacitance	C _{re}	V _{CB} =10V, I _E =0, f=1.0MHz			1.0	pF
Noise figure	NF	V _{CE} =10V, I _C =7mA, f=1.0GHz			2.0	dB

CLASSIFICATION OF h_{FE}

RANK	A	B	C
RANGE	50-160	160-240	240-300

TYPICAL CHARACTERISTICS (TA=25°C)

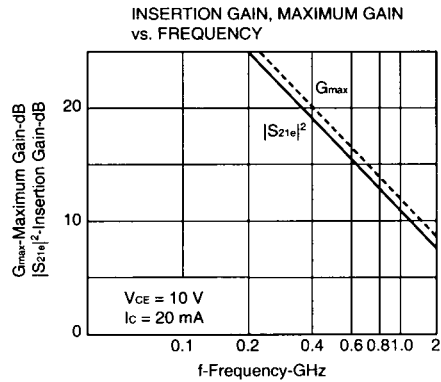
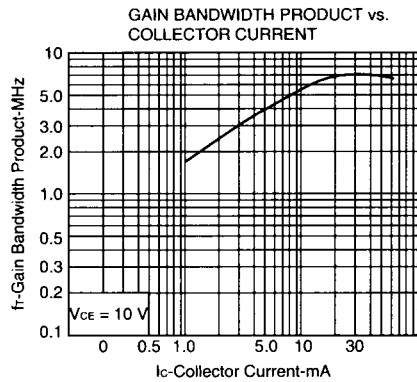
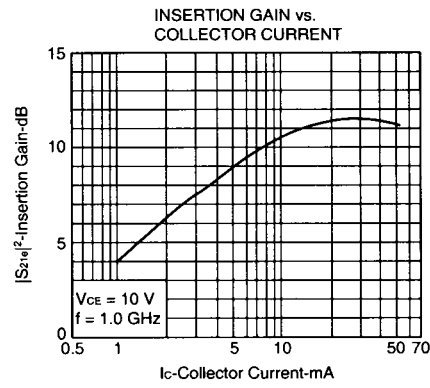
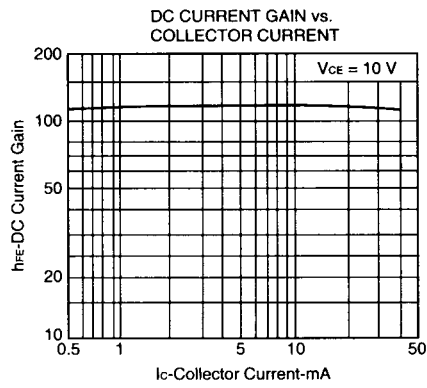
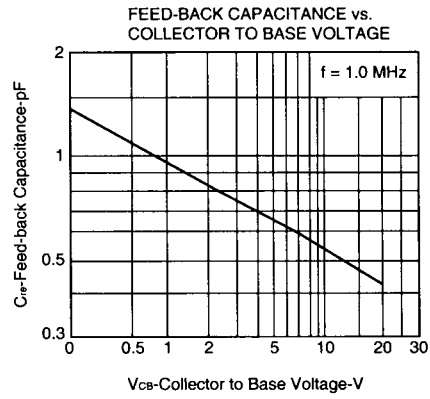
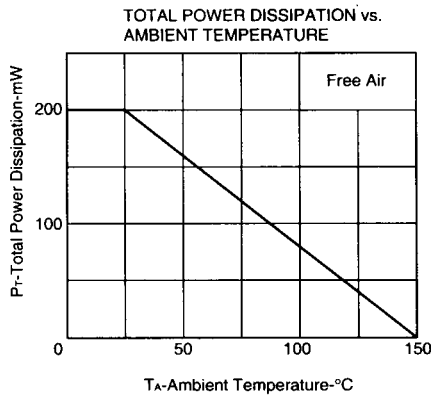

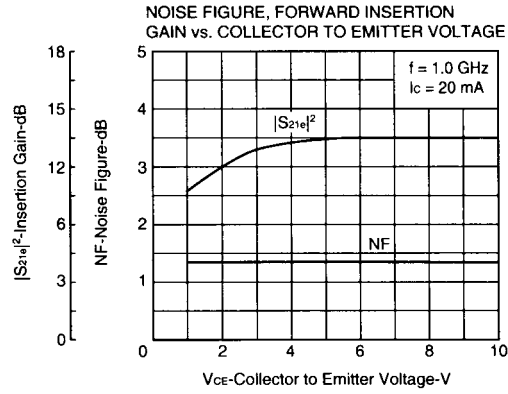
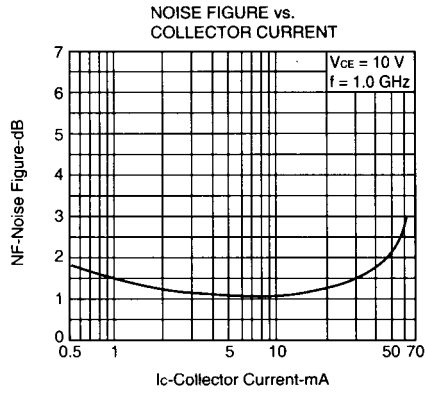

UTC assumes no responsibility for equipment failures that result from using products at values that exceed, even momentarily, rated values (such as maximum ratings, operating condition ranges, or other parameters) listed in products specifications of any and all UTC products described or contained herein. UTC products are not designed for use in life support appliances, devices or systems where malfunction of these products can be reasonably expected to result in personal injury. Reproduction in whole or in part is prohibited without the prior written consent of the copyright owner. The information presented in this document does not form part of any quotation or contract, is believed to be accurate and reliable and may be changed without notice.