

Sideview LED, 5 mm Tinted Diffused

Features

- Even luminance of the emitting surface
- Wide viewing angle
- Yellow and green color categorized
- For DC and pulse operation
- Lead-free device

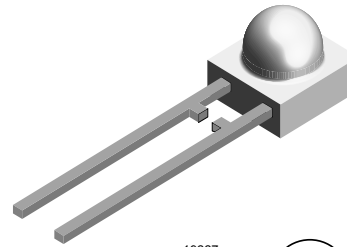

19227



Applications

Indicating and illumination purposes

Parts Table

Part	Color, Luminous Intensity	Angle of Half Intensity ($\pm\phi$)	Technology
TLPR5600	Red, $I_V > 1$ mcd	80 °	GaAsP on GaP
TLPH5600	Red, $I_V > 0.63$ mcd	80 °	GaAsP on GaP
TLPY5600	Yellow, $I_V > 0.63$ mcd	80 °	GaAsP on GaP
TLPG5600	Green, $I_V > 0.63$ mcd	80 °	GaP on GaP
TLPP5600	Pure green, $I_V > 0.63$ mcd	80 °	GaP on GaP

Absolute Maximum Ratings

$T_{amb} = 25$ °C, unless otherwise specified

TLPR5600, TLPH5600, TLPY5600, TLPG5600, TLPP5600

Parameter	Test condition	Part	Symbol	Value	Unit
Reverse voltage			V_R	6	V
DC Forward current		TLPR5600	I_F	20	mA
		TLPH5600	I_F	30	mA
		TLPY5600	I_F	30	mA
		TLPG5600	I_F	30	mA
		TLPP5600	I_F	30	mA
Surge forward current	$t_p \leq 10$ μ s		I_{FSM}	1	A
Power dissipation	$T_{amb} \leq 60$ °C	TLPR5600	P_V	60	mW
		TLPH5600	P_V	100	mW
		TLPY5600	P_V	100	mW
		TLPG5600	P_V	100	mW
		TLPP5600	P_V	100	mW
Junction temperature			T_j	100	°C
Operating temperature range			T_{amb}	- 40 to + 100	°C
Storage temperature range			T_{stg}	- 55 to + 100	°C
Soldering temperature	$t \leq 5$ s, 2 mm from body		T_{sd}	260	°C

Parameter	Test condition	Part	Symbol	Value	Unit
Thermal resistance junction/ ambient		TLPR5600	R_{thJA}	500	K
		TLPH5600	R_{thJA}	400	K/W
		TLPY5600	R_{thJA}	400	K/W
		TLPG5600	R_{thJA}	400	K/W
		TLPP5600	R_{thJA}	400	K/W

Optical and Electrical Characteristics

$T_{amb} = 25\text{ }^{\circ}\text{C}$, unless otherwise specified

Red

TLPR5600

Parameter	Test condition	Symbol	Min	Typ.	Max	Unit
Luminous intensity ¹⁾	$I_F = 10\text{ mA}$	I_V	1	2.5		mcd
Dominant wavelength	$I_F = 10\text{ mA}$	λ_d		630		nm
Peak wavelength	$I_F = 10\text{ mA}$	λ_p		640		nm
Angle of half intensity	$I_F = 10\text{ mA}$	ϕ		± 80		deg
Forward voltage	$I_F = 20\text{ mA}$	V_F		2	3	V
Reverse voltage	$I_R = 10\text{ }\mu\text{A}$	V_R	6	15		V
Junction capacitance	$V_R = 0, f = 1\text{ MHz}$	C_j		50		pF

¹⁾ in one Packing Unit $I_{Vmin}/I_{Vmax} \leq 0.5$

Red

TLPH5600

Parameter	Test condition	Symbol	Min	Typ.	Max	Unit
Luminous intensity ¹⁾	$I_F = 10\text{ mA}$	I_V	0.63	1.5		mcd
Dominant wavelength	$I_F = 10\text{ mA}$	λ_d	612		625	nm
Peak wavelength	$I_F = 10\text{ mA}$	λ_p		635		nm
Angle of half intensity	$I_F = 10\text{ mA}$	ϕ		± 80		deg
Forward voltage	$I_F = 20\text{ mA}$	V_F		2	3	V
Reverse voltage	$I_R = 10\text{ }\mu\text{A}$	V_R	6	15		V
Junction capacitance	$V_R = 0, f = 1\text{ MHz}$	C_j		50		pF

¹⁾ in one Packing Unit $I_{Vmin}/I_{Vmax} \leq 0.5$

Yellow

TLPY5600

Parameter	Test condition	Symbol	Min	Typ.	Max	Unit
Luminous intensity ¹⁾	$I_F = 10\text{ mA}$	I_V	0.63	1.5		mcd
Dominant wavelength	$I_F = 10\text{ mA}$	λ_d	581		594	nm
Peak wavelength	$I_F = 10\text{ mA}$	λ_p		585		nm
Angle of half intensity	$I_F = 10\text{ mA}$	ϕ		± 80		deg
Forward voltage	$I_F = 20\text{ mA}$	V_F		2.4	3	V
Reverse voltage	$I_R = 10\text{ }\mu\text{A}$	V_R	6	15		V
Junction capacitance	$V_R = 0, f = 1\text{ MHz}$	C_j		50		pF

¹⁾ in one Packing Unit $I_{Vmin}/I_{Vmax} \leq 0.5$

Green

TLPG5600

Parameter	Test condition	Symbol	Min	Typ.	Max	Unit
Luminous intensity ¹⁾	$I_F = 10 \text{ mA}$	I_V	0.63	1.5		mcd
Dominant wavelength	$I_F = 10 \text{ mA}$	λ_d	562		575	nm
Peak wavelength	$I_F = 10 \text{ mA}$	λ_p		565		nm
Angle of half intensity	$I_F = 10 \text{ mA}$	ϕ		± 80		deg
Forward voltage	$I_F = 20 \text{ mA}$	V_F		2.4	3	V
Reverse voltage	$I_R = 10 \mu\text{A}$	V_R	6	15		V
Junction capacitance	$V_R = 0, f = 1 \text{ MHz}$	C_j		50		pF

¹⁾ in one Packing Unit $I_{Vmin}/I_{Vmax} \leq 0.5$

Pure green

TLPP5600

Parameter	Test condition	Symbol	Min	Typ.	Max	Unit
Luminous intensity ¹⁾	$I_F = 10 \text{ mA}$	I_V	0.63	1.6		mcd
Dominant wavelength	$I_F = 10 \text{ mA}$	λ_d	555		565	nm
Peak wavelength	$I_F = 10 \text{ mA}$	λ_p		555		nm
Angle of half intensity	$I_F = 10 \text{ mA}$	ϕ		± 80		deg
Forward voltage	$I_F = 20 \text{ mA}$	V_F		2.4	3	V
Reverse voltage	$I_R = 10 \mu\text{A}$	V_R	6	15		V
Junction capacitance	$V_R = 0, f = 1 \text{ MHz}$	C_j		50		pF

¹⁾ in one Packing Unit $I_{Vmin}/I_{Vmax} \leq 0.5$

Typical Characteristics ($T_{amb} = 25 \text{ }^\circ\text{C}$ unless otherwise specified)

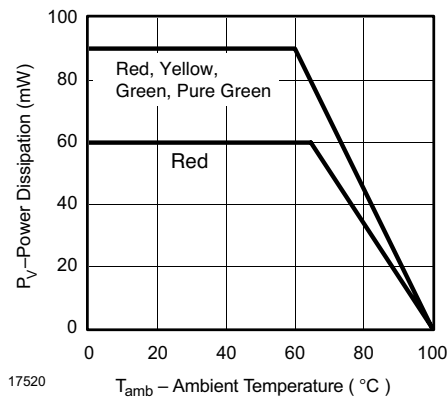

Figure 1. Power Dissipation vs. Ambient Temperature



Figure 2. Forward Current vs. Ambient Temperature

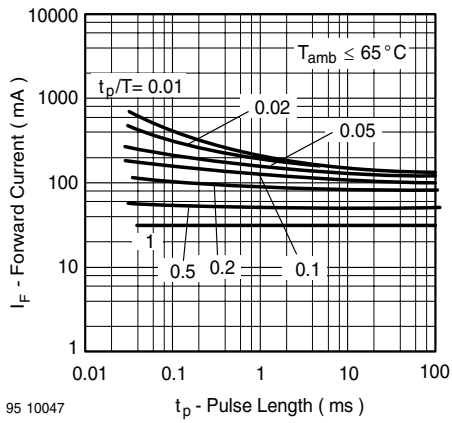

Figure 3. Forward Current vs. Pulse Length

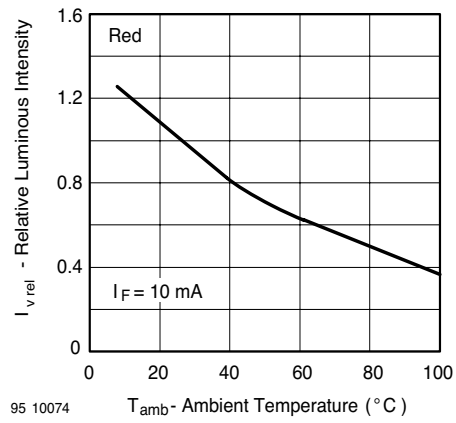

Figure 6. Rel. Luminous Intensity vs. Ambient Temperature

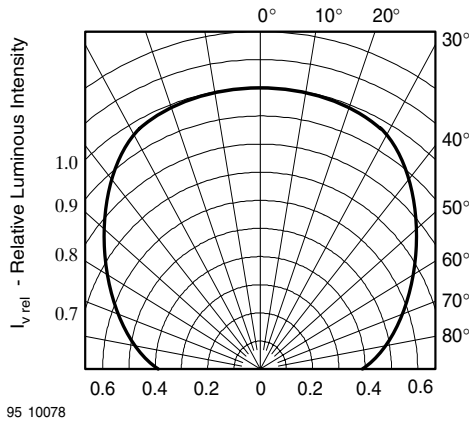

Figure 4. Rel. Luminous Intensity vs. Angular Displacement

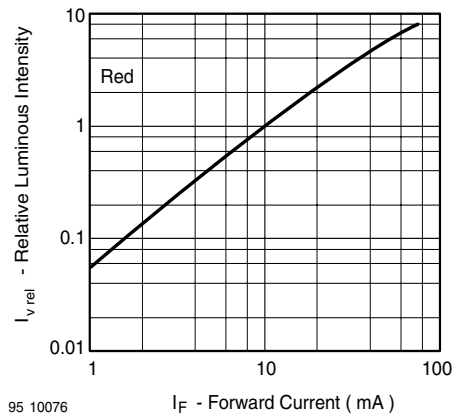

Figure 7. Relative Luminous Intensity vs. Forward Current

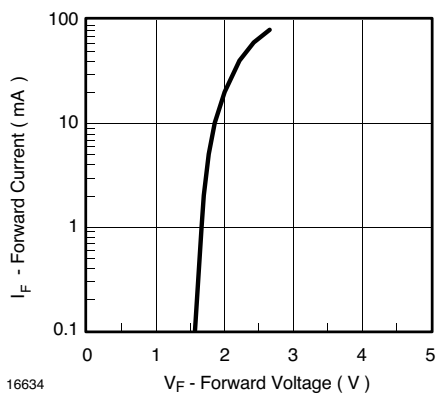

Figure 5. Forward Current vs. Forward Voltage

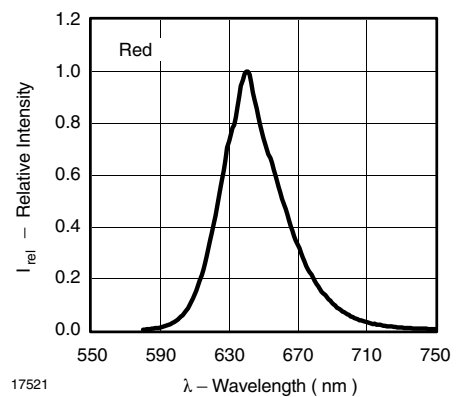
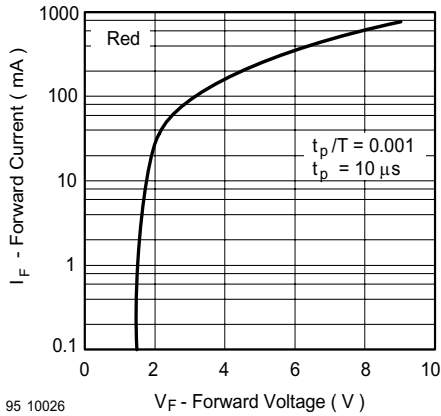
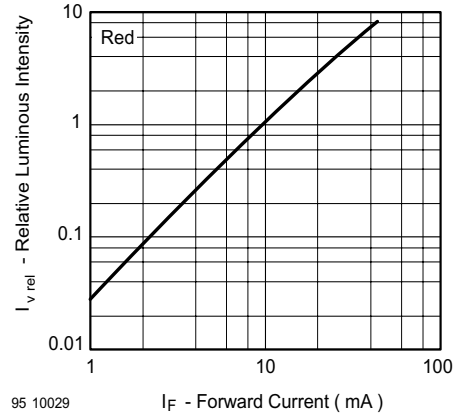

Figure 8. Relative Intensity vs. Wavelength



95 10026

Figure 9. Forward Current vs. Forward Voltage



95 10029

Figure 12. Relative Luminous Intensity vs. Forward Current

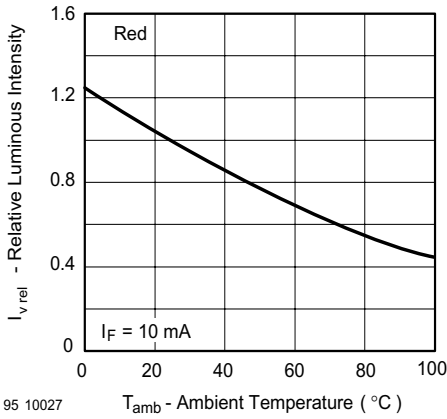

95 10027

Figure 10. Rel. Luminous Intensity vs. Ambient Temperature

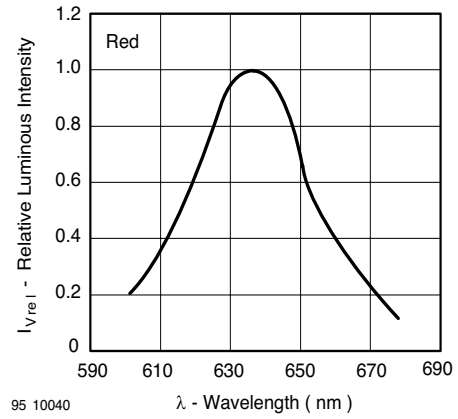

95 10040

Figure 13. Relative Intensity vs. Wavelength

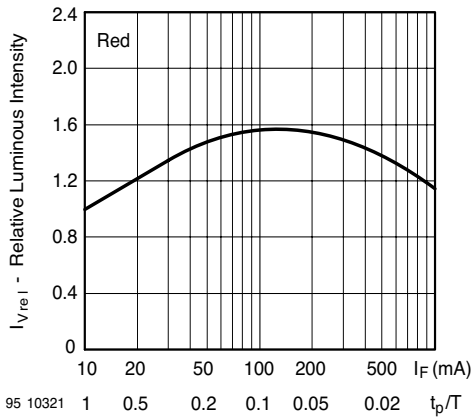

95 10321

Figure 11. Rel. Lumin. Intensity vs. Forw. Current/Duty Cycle

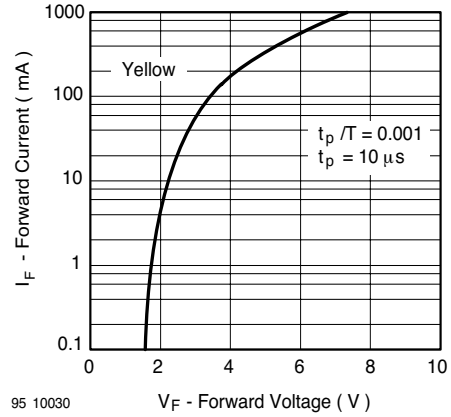

95 10030

Figure 14. Forward Current vs. Forward Voltage

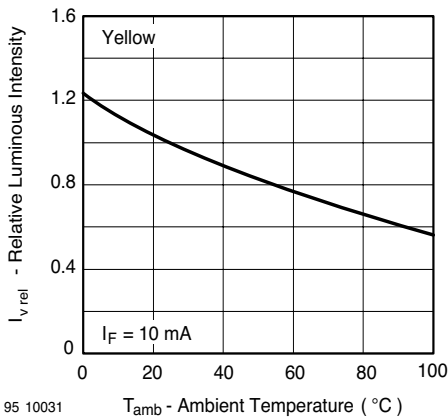

95 10031 T_{amb} - Ambient Temperature ($^{\circ}C$)
 Figure 15. Rel. Luminous Intensity vs. Ambient Temperature

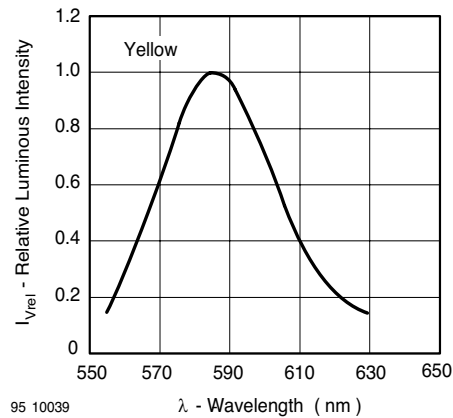

95 10039 λ - Wavelength (nm)
 Figure 18. Relative Intensity vs. Wavelength

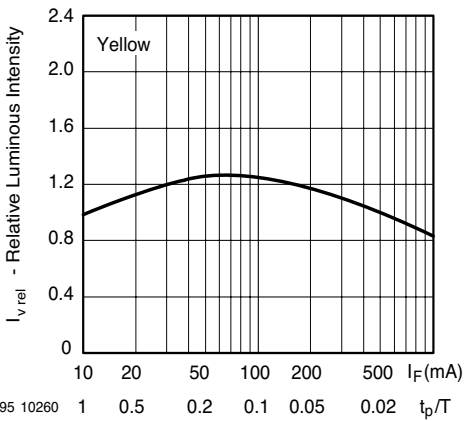

95 10260 1 0.5 0.2 0.1 0.05 0.02 t_p/T
 Figure 16. Rel. Lumin. Intensity vs. Forw. Current/Duty Cycle

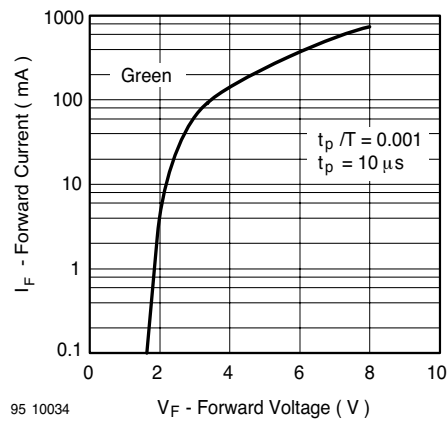

95 10034 V_F - Forward Voltage (V)
 Figure 19. Forward Current vs. Forward Voltage

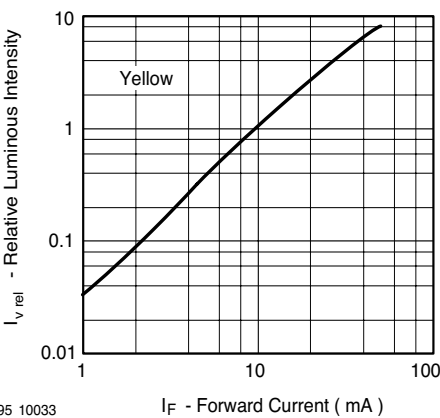

95 10033 I_F - Forward Current (mA)
 Figure 17. Relative Luminous Intensity vs. Forward Current

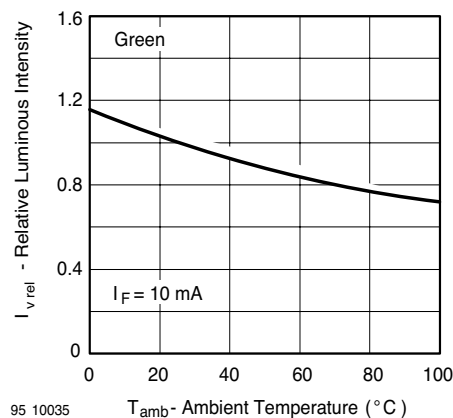

95 10035 T_{amb} - Ambient Temperature ($^{\circ}C$)
 Figure 20. Rel. Luminous Intensity vs. Ambient Temperature

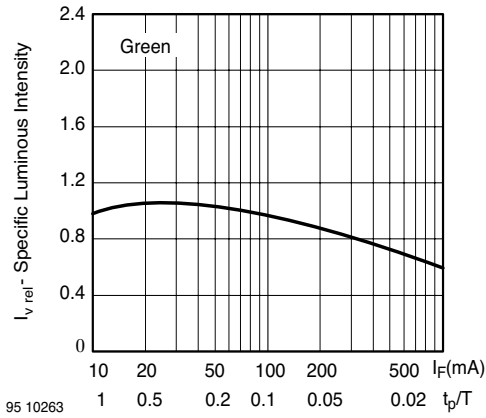

Figure 21. Specific Luminous Intensity vs. Forward Current

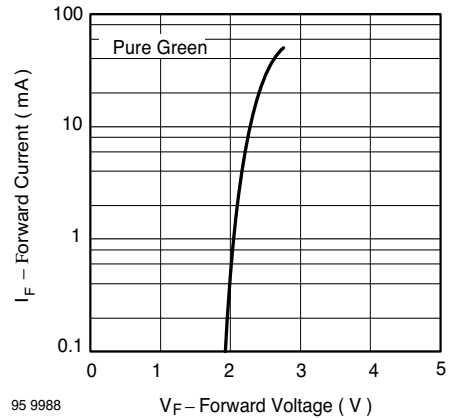

Figure 24. Forward Current vs. Forward Voltage

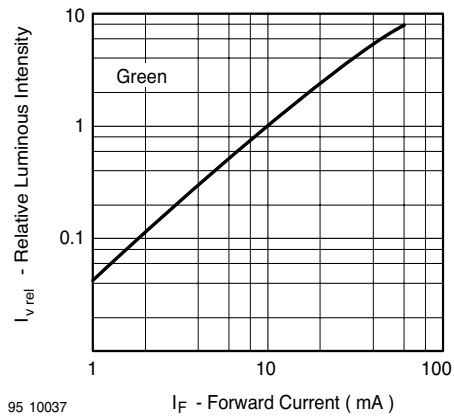

Figure 22. Relative Luminous Intensity vs. Forward Current

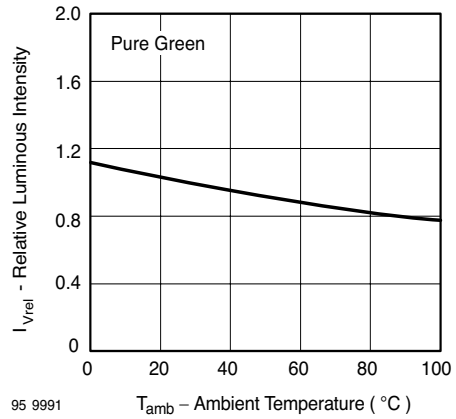

Figure 25. Rel. Luminous Intensity vs. Ambient Temperature

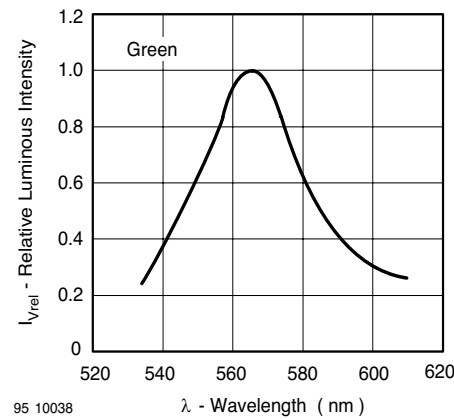

Figure 23. Relative Intensity vs. Wavelength

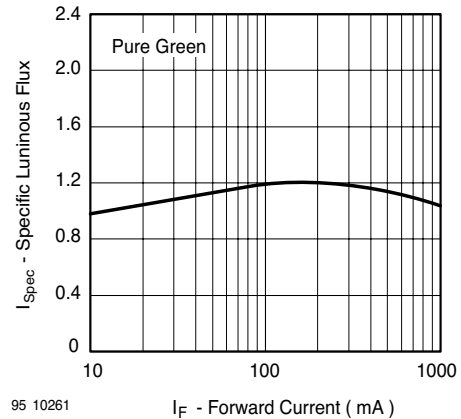

Figure 26. Specific Luminous Intensity vs. Forward Current

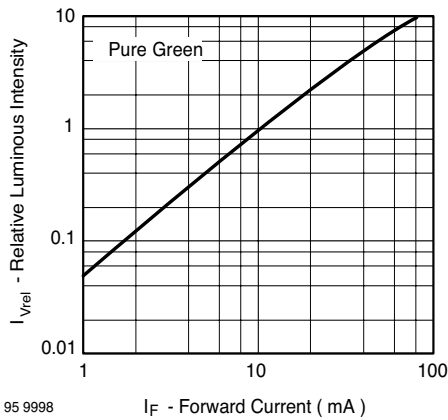

Figure 27. Relative Luminous Intensity vs. Forward Current

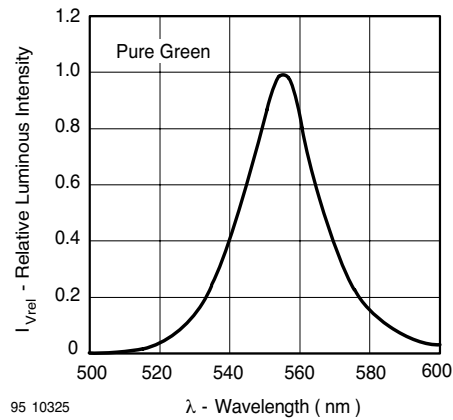
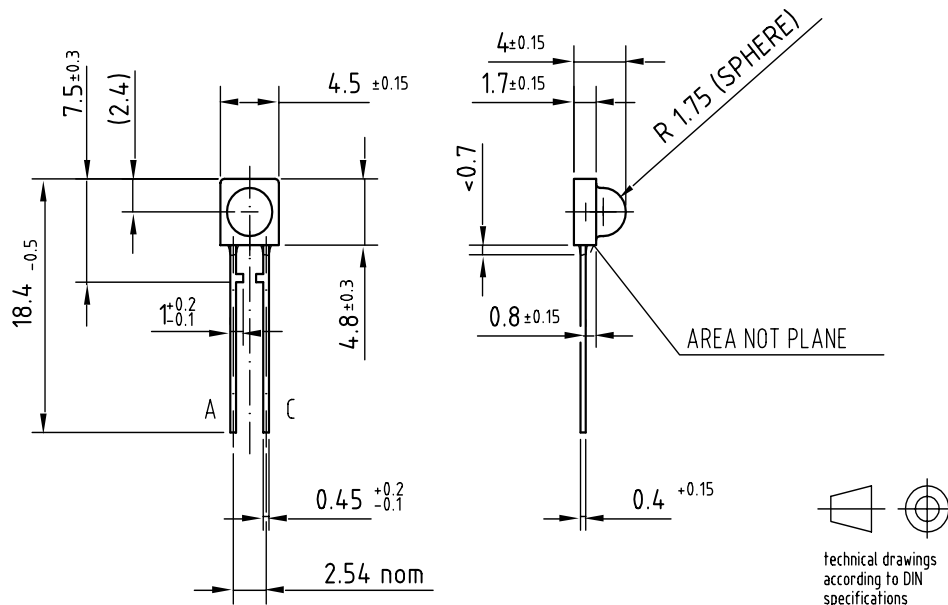

Figure 28. Relative Intensity vs. Wavelength

Package Dimensions in mm



All dimensions in mm

Drawing-No.: 6.544-5127.01-4
Issue: 1; 15.11.95

95 11321



Ozone Depleting Substances Policy Statement

It is the policy of **Vishay Semiconductor GmbH** to

1. Meet all present and future national and international statutory requirements.
2. Regularly and continuously improve the performance of our products, processes, distribution and operating systems with respect to their impact on the health and safety of our employees and the public, as well as their impact on the environment.

It is particular concern to control or eliminate releases of those substances into the atmosphere which are known as ozone depleting substances (ODSs).

The Montreal Protocol (1987) and its London Amendments (1990) intend to severely restrict the use of ODSs and forbid their use within the next ten years. Various national and international initiatives are pressing for an earlier ban on these substances.

Vishay Semiconductor GmbH has been able to use its policy of continuous improvements to eliminate the use of ODSs listed in the following documents.

1. Annex A, B and list of transitional substances of the Montreal Protocol and the London Amendments respectively
2. Class I and II ozone depleting substances in the Clean Air Act Amendments of 1990 by the Environmental Protection Agency (EPA) in the USA
3. Council Decision 88/540/EEC and 91/690/EEC Annex A, B and C (transitional substances) respectively.

Vishay Semiconductor GmbH can certify that our semiconductors are not manufactured with ozone depleting substances and do not contain such substances.

**We reserve the right to make changes to improve technical design
and may do so without further notice.**

Parameters can vary in different applications. All operating parameters must be validated for each customer application by the customer. Should the buyer use Vishay Semiconductors products for any unintended or unauthorized application, the buyer shall indemnify Vishay Semiconductors against all claims, costs, damages, and expenses, arising out of, directly or indirectly, any claim of personal damage, injury or death associated with such unintended or unauthorized use.

Vishay Semiconductor GmbH, P.O.B. 3535, D-74025 Heilbronn, Germany
Telephone: 49 (0)7131 67 2831, Fax number: 49 (0)7131 67 2423



Notice

Specifications of the products displayed herein are subject to change without notice. Vishay Intertechnology, Inc., or anyone on its behalf, assumes no responsibility or liability for any errors or inaccuracies.

Information contained herein is intended to provide a product description only. No license, express or implied, by estoppel or otherwise, to any intellectual property rights is granted by this document. Except as provided in Vishay's terms and conditions of sale for such products, Vishay assumes no liability whatsoever, and disclaims any express or implied warranty, relating to sale and/or use of Vishay products including liability or warranties relating to fitness for a particular purpose, merchantability, or infringement of any patent, copyright, or other intellectual property right.

The products shown herein are not designed for use in medical, life-saving, or life-sustaining applications. Customers using or selling these products for use in such applications do so at their own risk and agree to fully indemnify Vishay for any damages resulting from such improper use or sale.