



## Product Description

Sirenza Microdevices' SXB-4089 amplifier is a high efficiency InGaP/ GaAs Heterojunction Bipolar Transistor (HBT) MMIC housed in low-cost, surface-mountable plastic package.

These amplifiers are specially designed for use as driver devices for infrastructure equipment in the 400-2500 MHz cellular, ISM, WLL, PCS, W-CDMA applications.

Its high linearity makes it an ideal choice for multi-carrier as well as digital applications.

The matte tin finish on Sirenza's lead-free package utilizes a post annealing process to mitigate tin whisker formation and is RoHS compliant per EU Directive 2002/95. This package is also manufactured with green molding compounds that contain no antimony trioxide nor halogenated fire retardants.

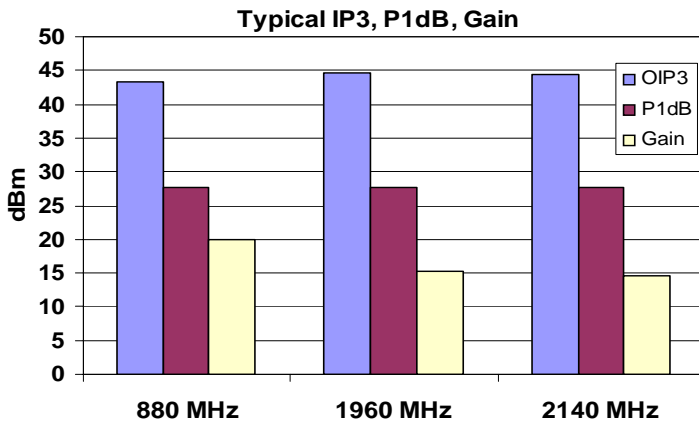

## SXB-4089

## SXB-4089Z



### 400-2500 MHz ½ W Medium Power InGaP/GaAs HBT Amplifier with Active Bias



### Product Features

- On-chip Active Bias Control, Single 5V Supply
- High Output 3rd Order Intercept: +45 dBm typ.
- High P1dB : +28 dBm typ.
- High Gain: +20 dB at 880 MHz
- Low Rth: 25°C/W typ.
- Robust 2000V ESD, Class 2

### Applications

- W-CDMA, PCS, Cellular Systems
- Multi-Carrier Applications

Symbol	Parameters	Units	Frequency	Min.	Typ.	Max.
P <sub>1dB</sub>	Output Power at 1 dB Compression	dBm	880 MHz 1960 MHz 2140 MHz	26	27.5 27.5 27.5	
S <sub>21</sub>	Small Signal Gain	dBm	880 MHz 1960 MHz 2140 MHz	18 12.5	20 15 14	22 15.5
S <sub>11</sub>	Input VSWR		880 MHz 1960 MHz 2140 MHz		1.3:1 1.3:1 1.3:1	2.0:1
OIP3	Output Third Order Intercept Point (P <sub>out</sub> /Tone = +11 dBm, Tone spacing = 1 MHz)	dBm	880 MHz 1960 MHz 2140 MHz	41.5 42.5	43.5 44.5 44.5	
NF	Noise Figure	dB	880 MHz 1960 MHz 2140 MHz		5.6 3.3 3.3	
V <sub>CC</sub>	Device Operating Voltage	V		4.75	5	5.25
I <sub>D</sub>	Device Operating Current	mA		235	265	295
R <sub>TH, j-l</sub>	Thermal Resistance (junction - lead)	°C/W			25.3	

**Test Conditions:** T<sub>a</sub> = 25°C Z<sub>0</sub> = 50 Ohms  
Measured in Application Circuit

The information provided herein is believed to be reliable at press time. Sirenza Microdevices assumes no responsibility for inaccuracies or omissions. Sirenza Microdevices assumes no responsibility for the use of this information, and all such information shall be entirely at the user's own risk. Prices and specifications are subject to change without notice. No patent rights or licenses to any of the circuits described herein are implied or granted to any third party. Sirenza Microdevices does not authorize or warrant any Sirenza Microdevices product for use in life-support devices and/or systems. Copyright 2001 Sirenza Microdevices, Inc.. All worldwide rights reserved.

880 MHz Application Circuit Data,  $V_{CC}=5V$ ,  $I_D=270mA$

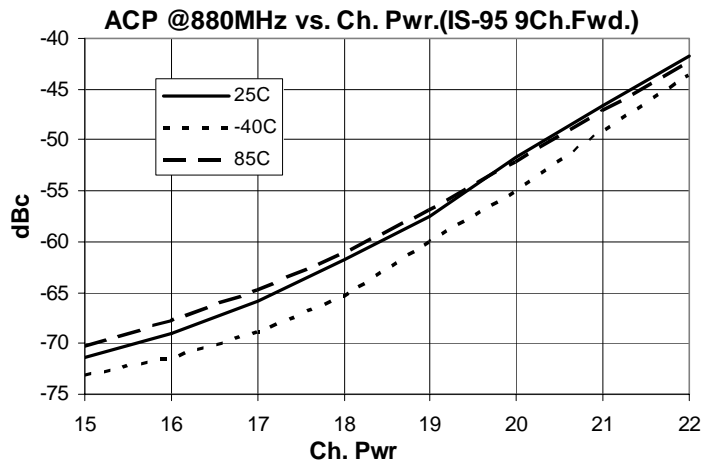
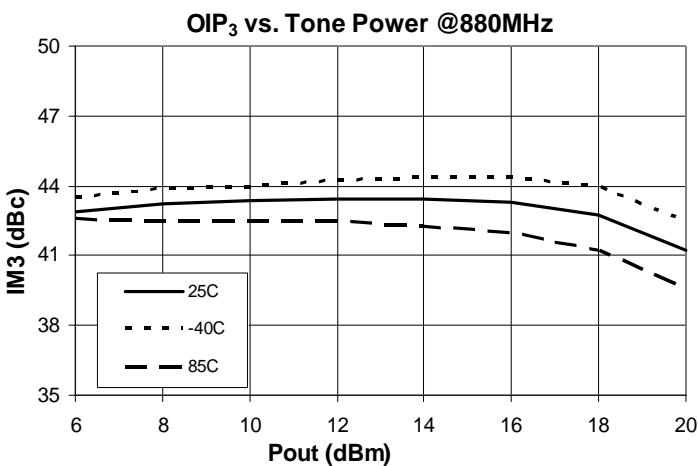
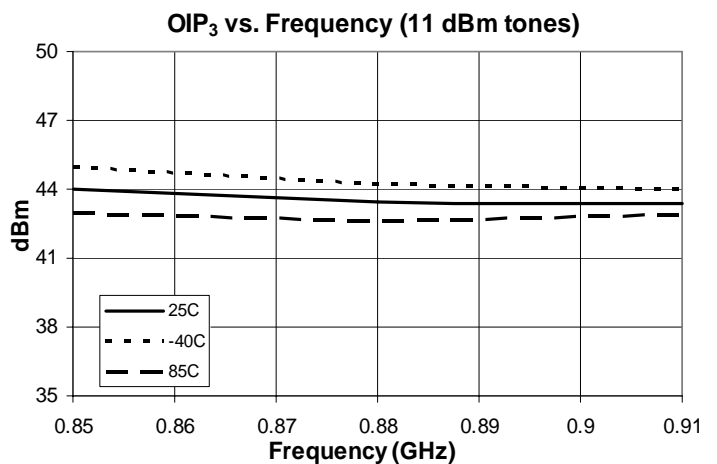
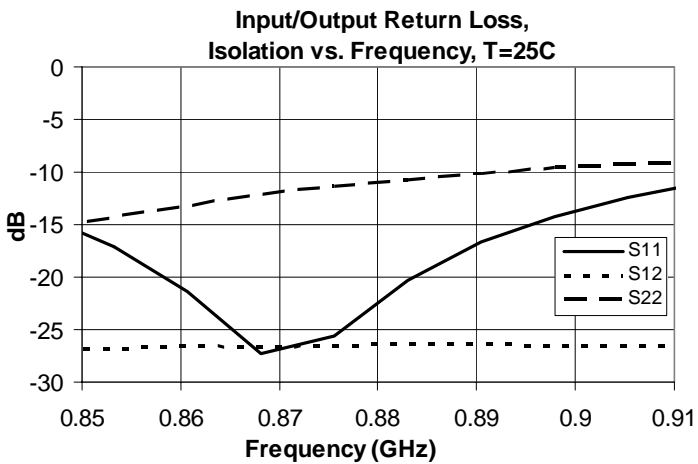
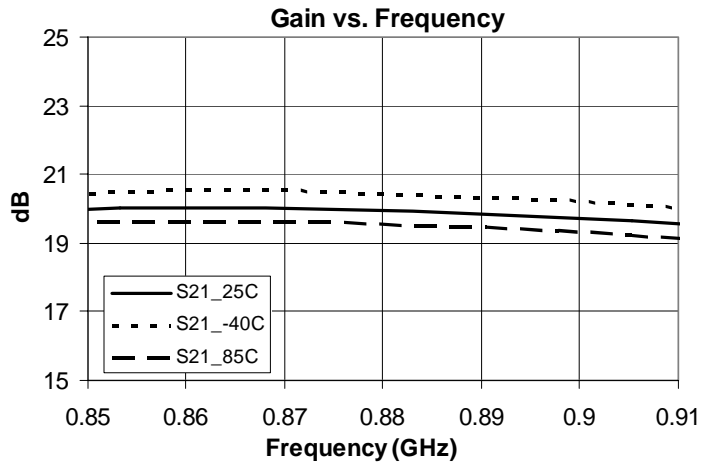
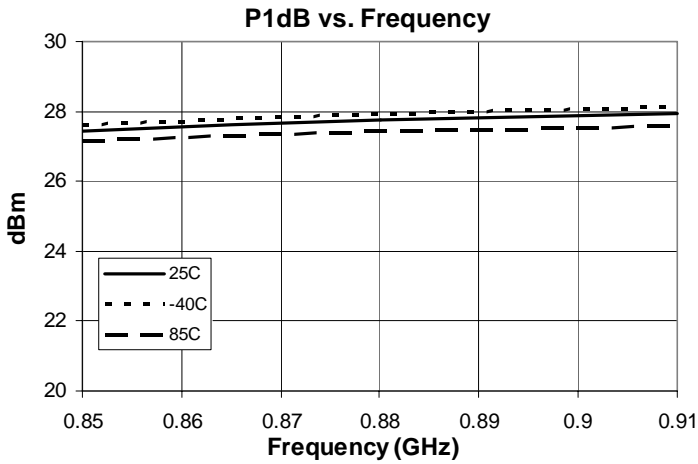

1960 MHz Application Circuit Data,  $V_{CC}=5V$ ,  $I_D=270mA$

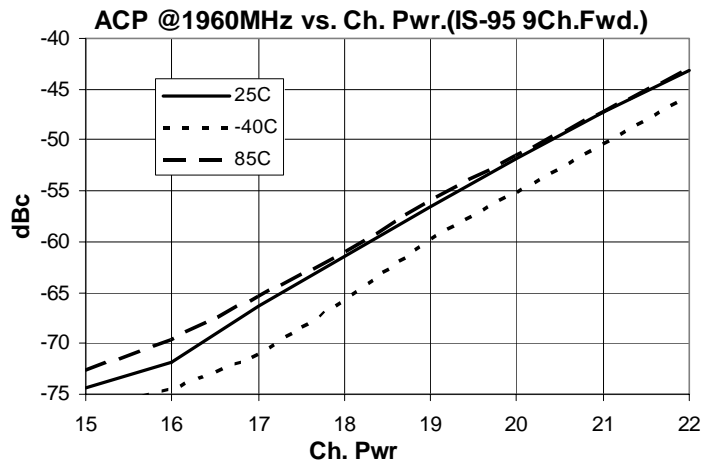
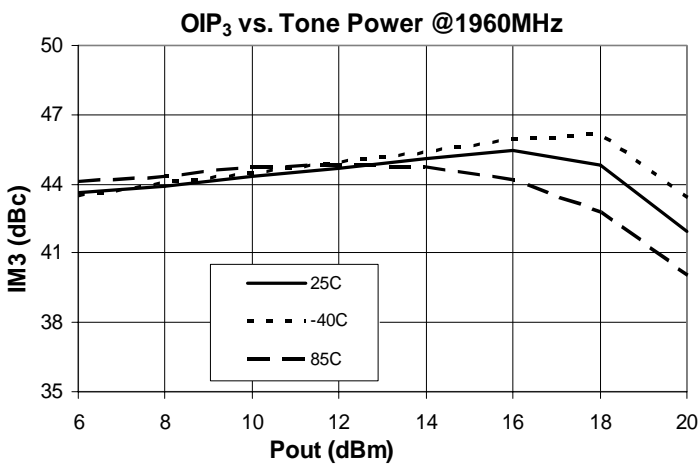
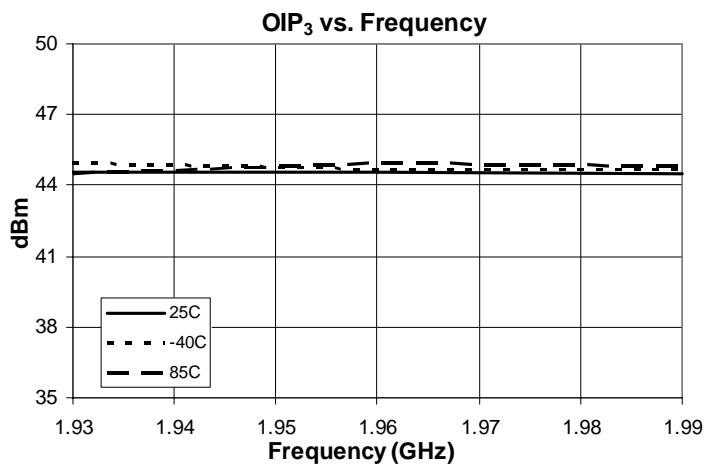
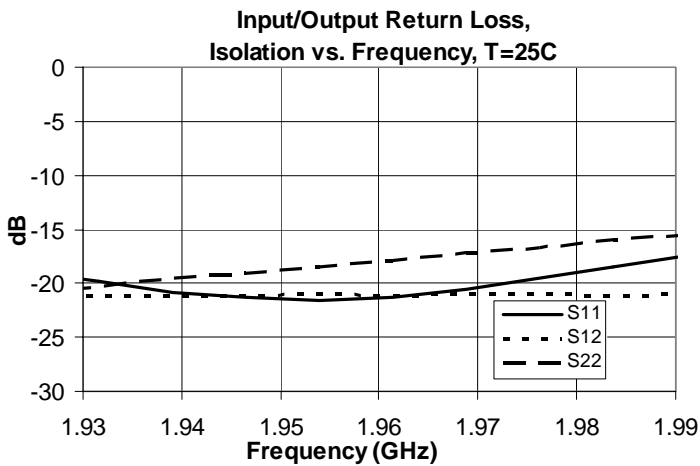
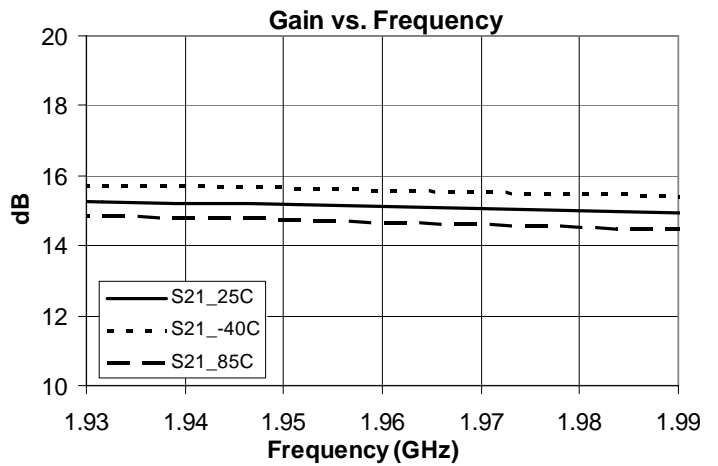
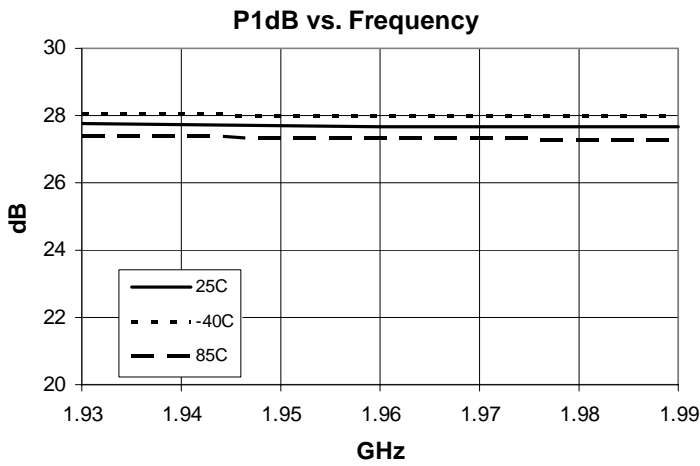

2140 MHz Application Circuit Data,  $V_{CC}=5V$ ,  $I_D=270mA$

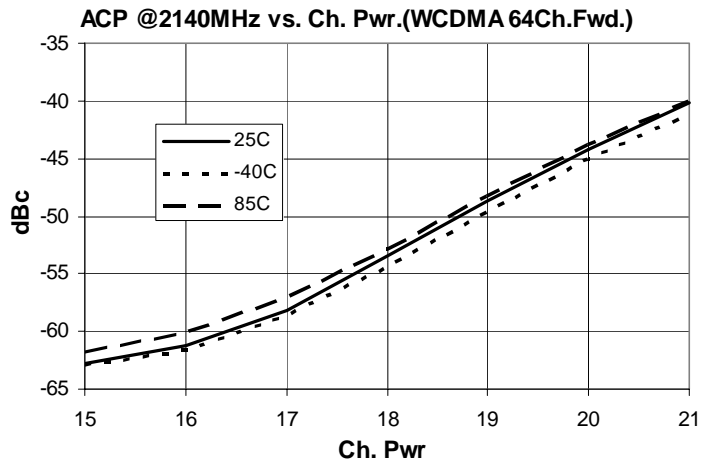
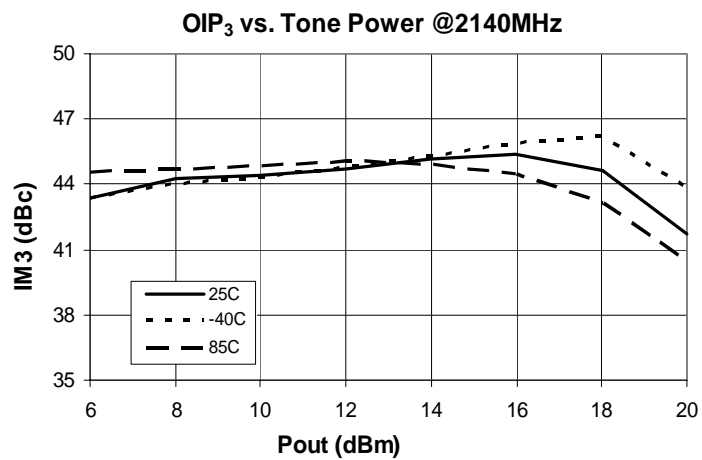
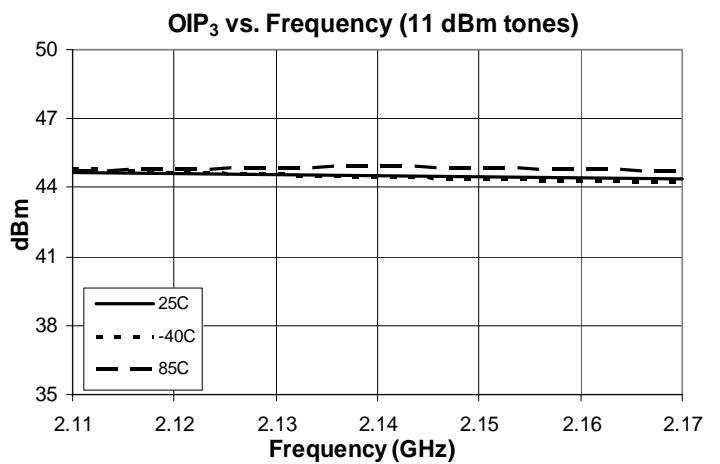
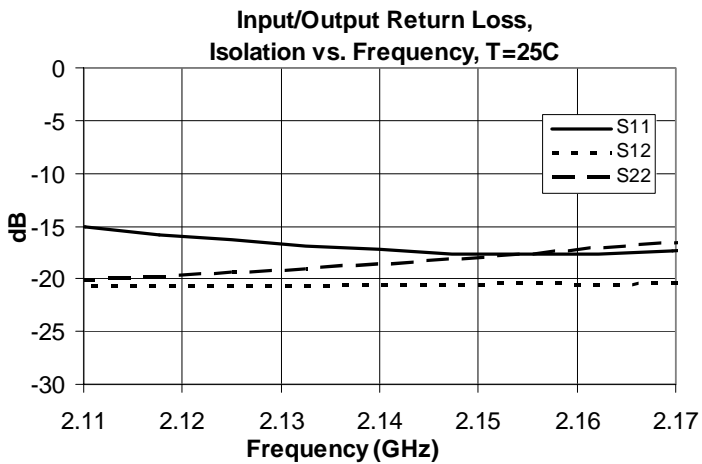
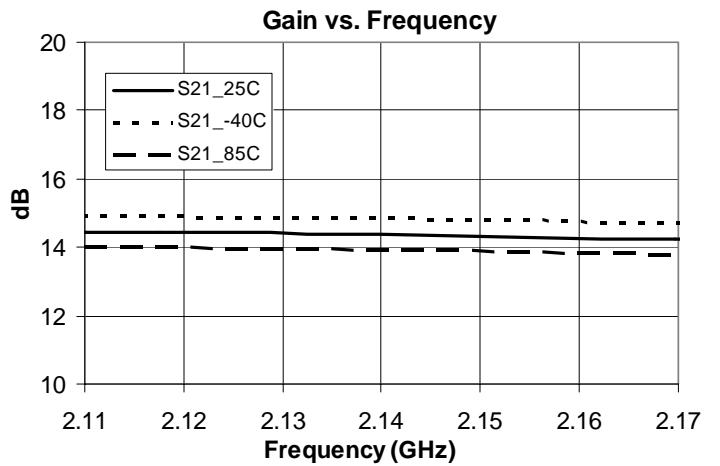
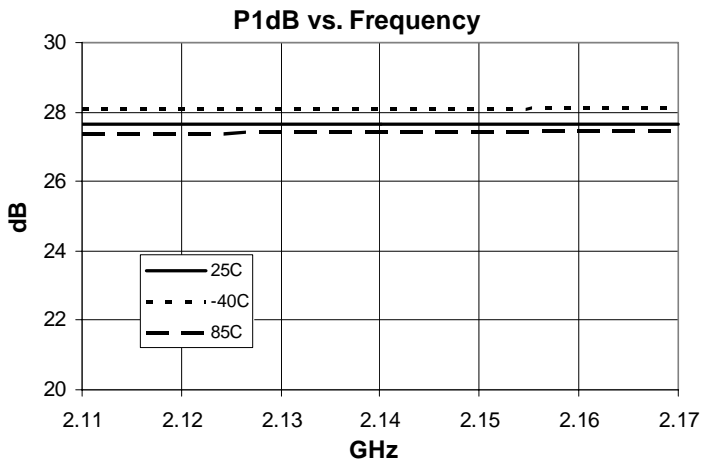

**Application Schematic for 880 MHz**

Bill of Materials

- C1 1x TAJB104KLRH Rohm 0.1uF
- C2 1x MCH185C102KK Rohm 1000pF
- C3 2x MCH185A680JK Rohm 68pF
- C4 1x MCH185A3R9CK Rohm 3.9pF
- C5 1x MCH185C4R7CK Rohm 4.7pF
- C6 1x MCH185C120CK Rohm 12pF
- L1 1x 0805HQ- Coilcraft 48nH
- L2 1x LL1608-FS2N7J Toko 2.7nH
- R1 1x 0603-Rohm 1ohm
- RF1 2x 142-0701-846 Johnson Comp.
- Heat sink EEF-101216
- PCB ECB-101499 C

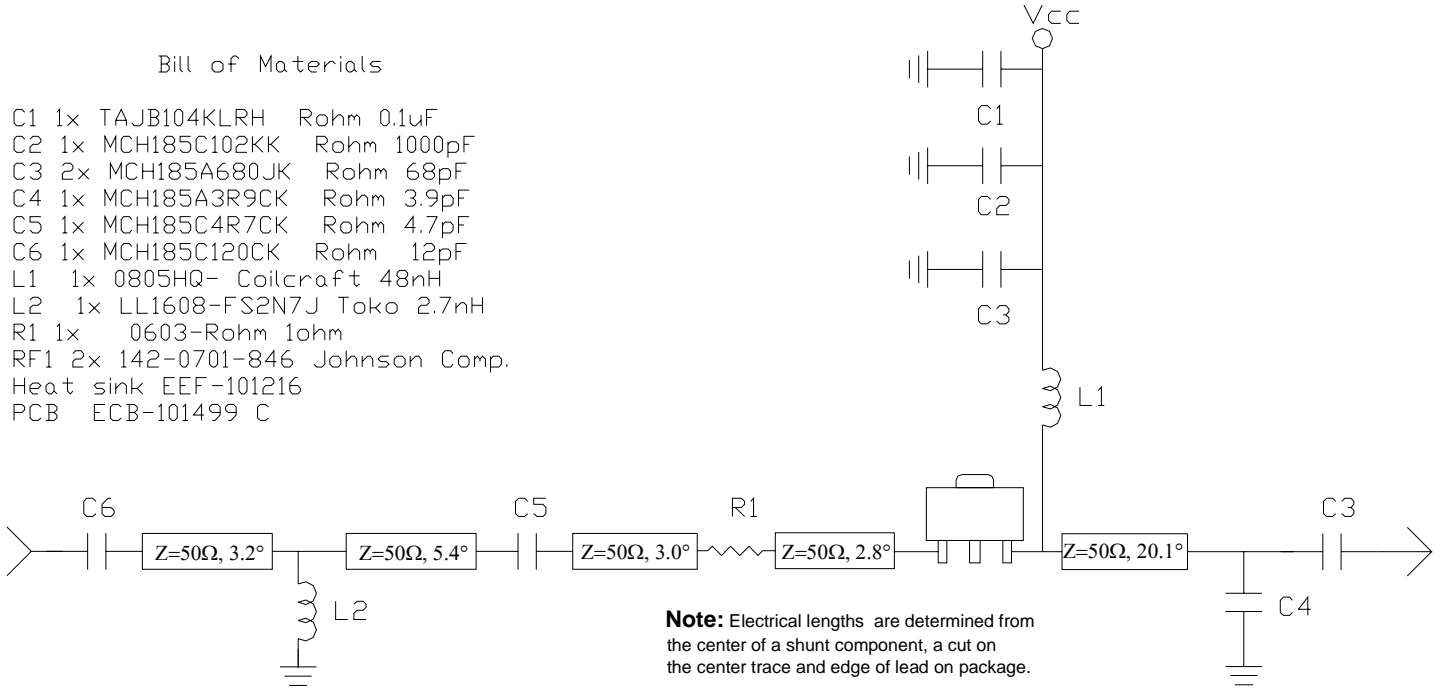

**Note:** Electrical lengths are determined from the center of a shunt component, a cut on the center trace and edge of lead on package.

**Evaluation Board Layout for 880 MHz**

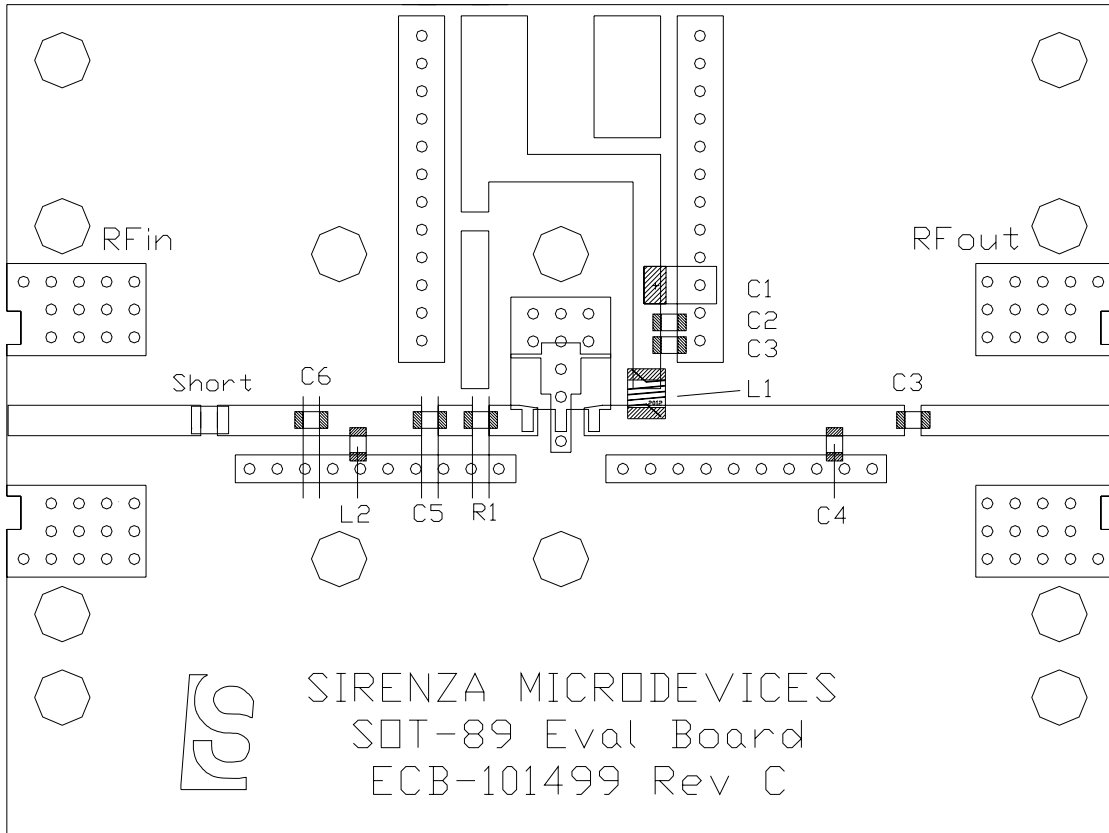

**Application Schematic for 1960 MHz**

Bill of Materials

C1	1x	TAJB104KLRH	Rohm	0.1uF
C2	1x	MCH185C102KK	Rohm	1000pF
C3	2x	MCH185A220JK	Rohm	22pF
C4	1x	MCH185A1R5CK	Rohm	1.5pF
C5	2x	MCH185A1R2CK	Rohm	1.2pF
C6	1x	MCH185A1R8CK	Rohm	1.8pF
L1	1x	0805HQ-	Coilcraft	20nH
RF1	2x	142-0701-846	Johnson Comp.	
Heat sink EEF-101216				
PCB ECB-101499 C				

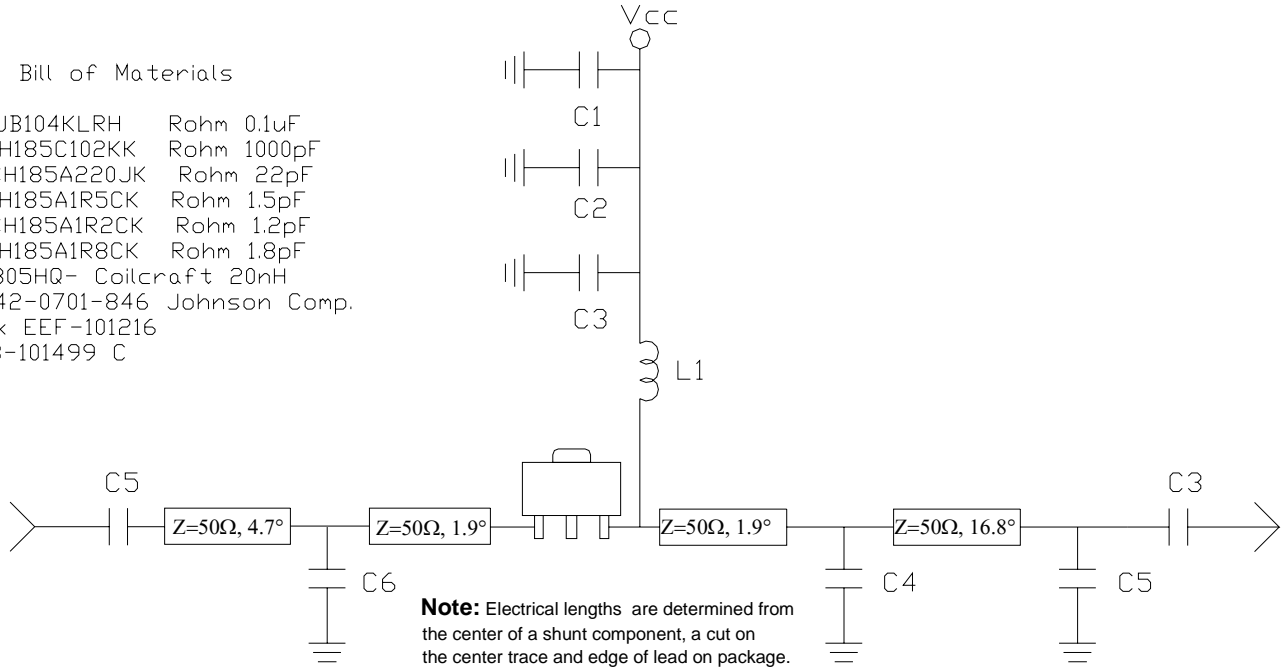

**Evaluation Board Layout for 1960 MHz**

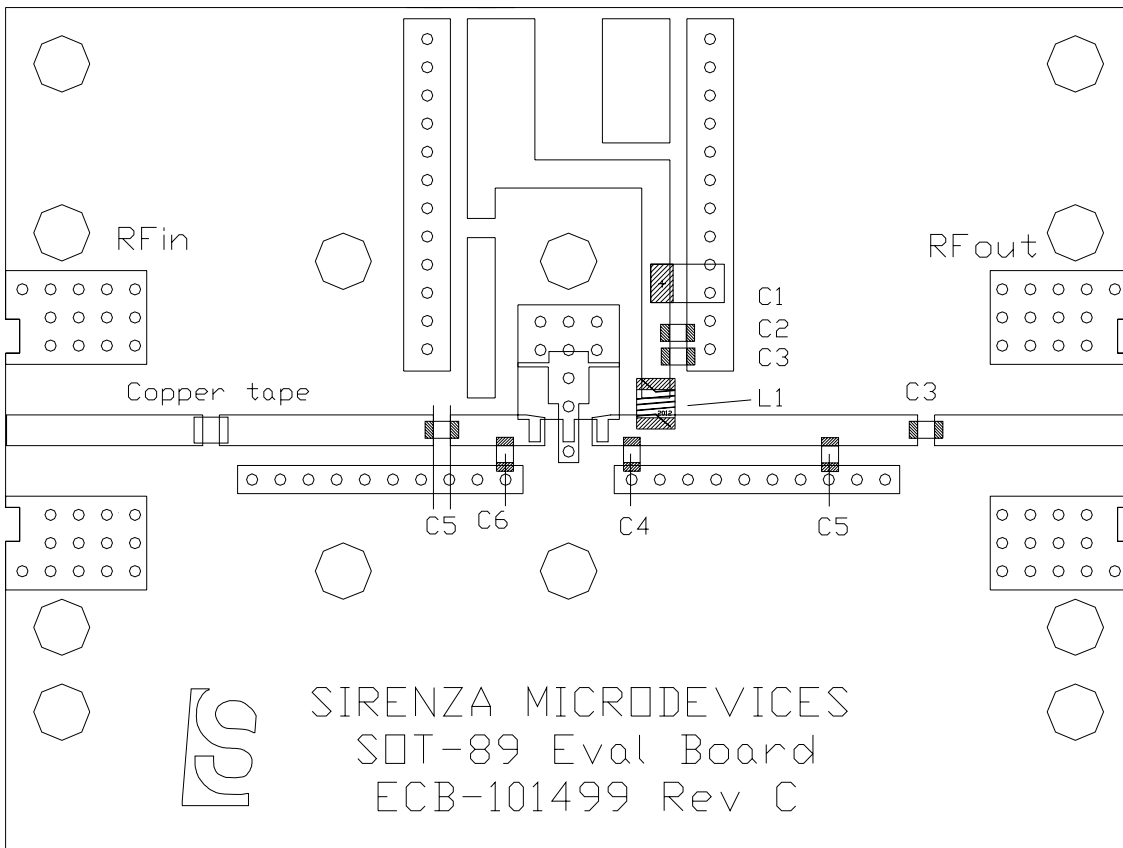

**Application Schematic for 2140 MHz**

Bill of Materials

- C1 1x TAJB104KLRH Rohm 0.1uF
- C2 1x MCH185C102KK Rohm 1000pF
- C3 2x MCH185A220JK Rohm 22pF
- C4 2x MCH185A1R5CK Rohm 1.5pF
- C5 2x MCH185A1R0CK Rohm 1.0pF
- L1 1x 0805HQ- Coilcraft 20nH
- RF1 2x 142-0701-846 Johnson Comp.
- Heat sink EEF-101216
- PCB ECB-101499 C

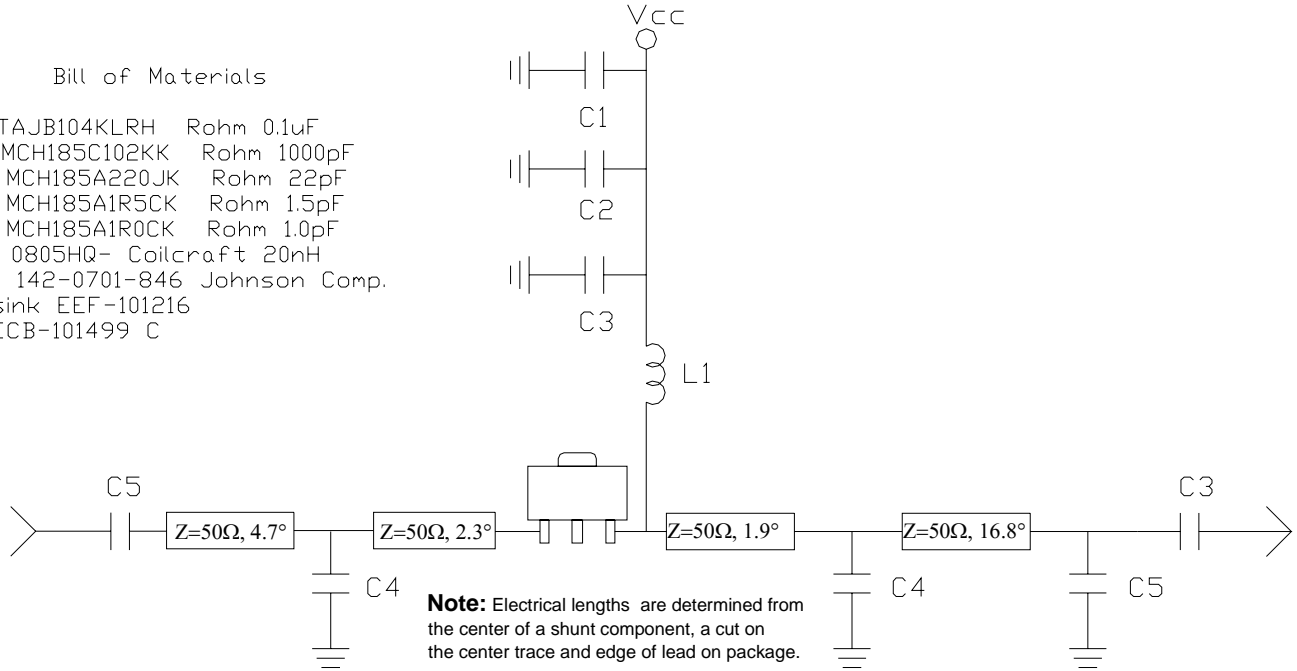

**Evaluation Board Layout for 2140 MHz**

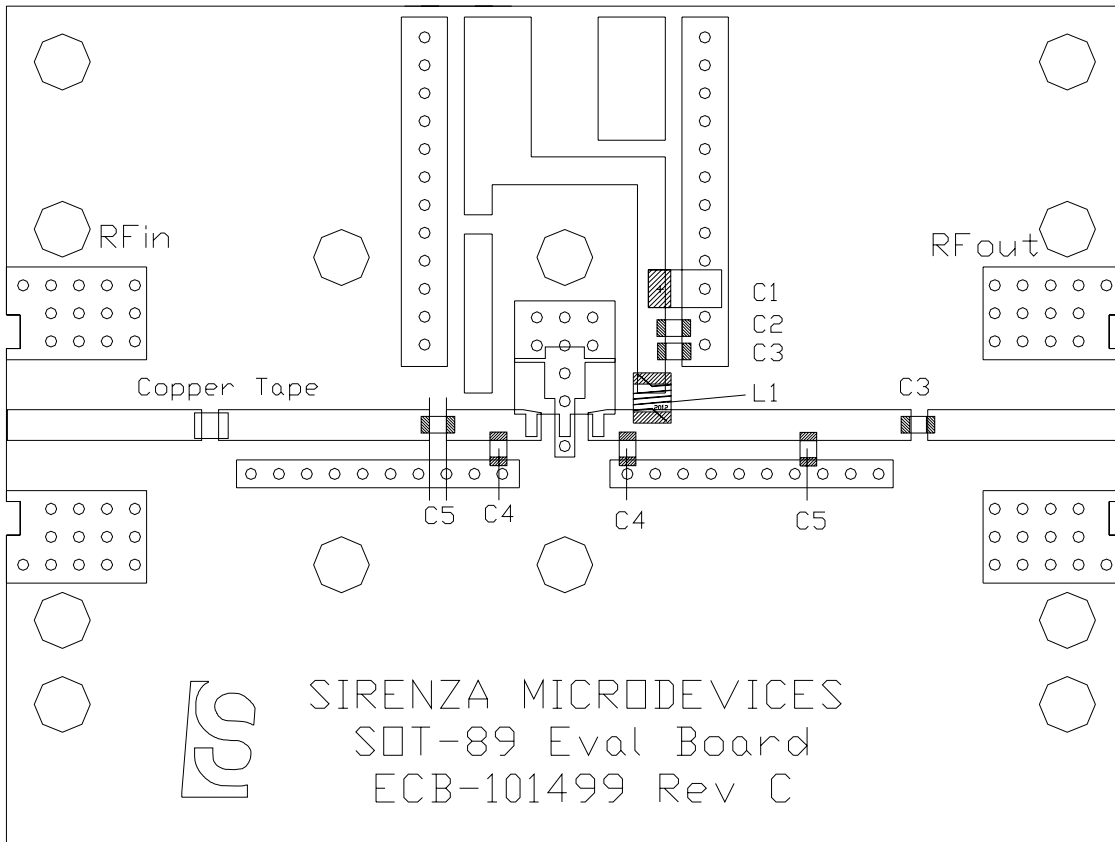

**Nominal Package Dimensions**

Dimensions in inches (millimeters)  
Refer to package drawing posted at [www.sirenza.com](http://www.sirenza.com) for tolerances

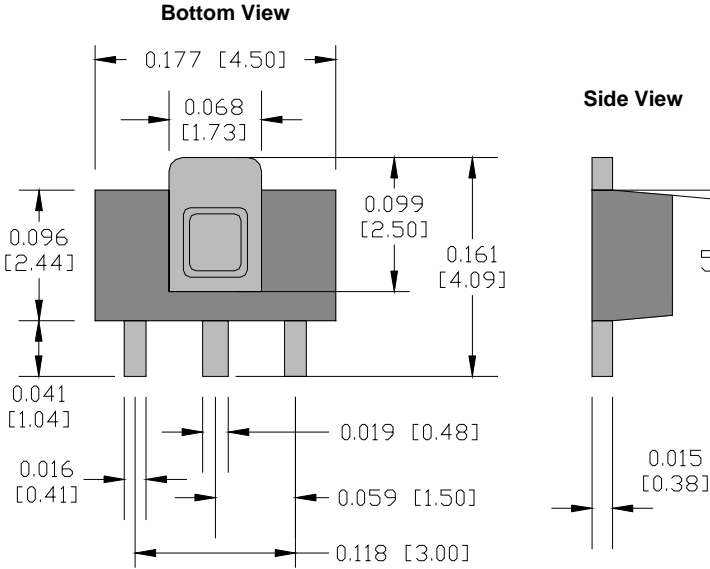

**Suggested PCB Pad Layout**

Dimensions in inches [millimeters]

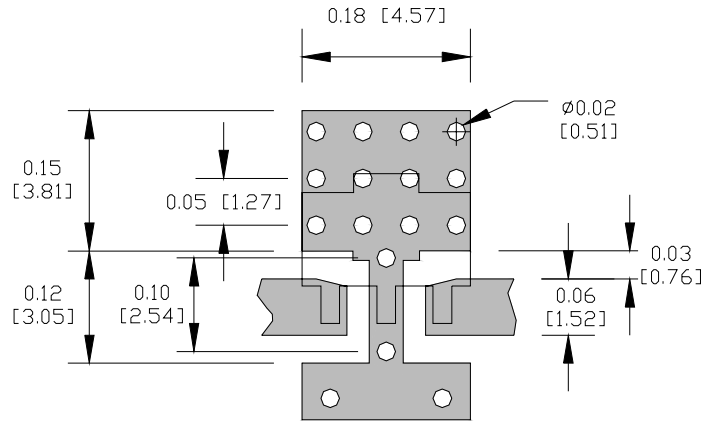

**Absolute Maximum Ratings**

Parameter	Absolute Limit
Max Device Current ( $I_D$ )	500 mA
Max Device Voltage ( $V_D$ )	6 V
Max. RF Input Power	60mW
Max. Dissipated Power	2W
Max. Junction Temp. ( $T_J$ )	+165°C
Operating Temp. Range ( $T_L$ )	-40°C to +85°C
Max. Storage Temp.	+150°C

Operation of this device beyond any one of these limits may cause permanent damage. For reliable continuous operation, the device voltage and current must not exceed the maximum operating values specified in the table on page one.

Bias Conditions should also satisfy the following expression:

$$I_D V_D < (T_J - T_L) / R_{TH, j-l} \quad T_L = T_{LEAD}$$

**Part Number Ordering Information**

Part Number	Reel Size	Devices / Reel
SXB-4089	7"	1000
SXB-4089Z	7"	1000

**Package Marking**

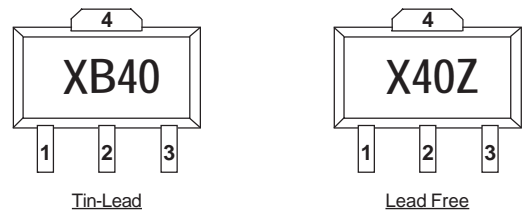

**ESD: Class 2** (Passes 2000V ESD Pulse)  
Appropriate precautions in handling, packaging and testing devices must be observed.

**MSL (Moisture Sensitivity Level) Rating: Level 1**

Pin #	Function	Description
1	RF IN	RF input pin. This pin requires the use of an external DC blocking capacitor chosen for the frequency of operation.
2, 4	GND	Connection to ground. Use via holes for best performance to reduce lead inductance as close to ground leads as possible
3	RF OUT/BIAS	RF output and bias pin. DC voltage is present on this pin, therefore a DC blocking capacitor is necessary for proper operation.