

DATA SHEET

SMV1130 Series: Hyperabrupt Junction Tuning Varactor

Features

- High tuning ratio
- Low series resistance
- SC-79 and SOT-23 packages
- Designed for high-volume, low-cost applications
- Available lead (Pb)-free and RoHS-compliant MSL-1 @ 260 °C per JEDEC J-STD-020



Description

The SMV1130 is a surface mount varactor diode offered in the SC-79 and SOT-23 plastic packages. This varactor is designed for very high capacitance tuning ratio while having low series resistance, which makes these devices especially attractive for wideband VCO applications.

NEW

Skyworks offers lead (Pb)-free, RoHS (Restriction of Hazardous Substances)-compliant packaging.



Absolute Maximum Ratings



Characteristic	Value
Reverse voltage (V_R)	26 V
Forward current (I_F)	20 mA
Power dissipation (P_D)	250 mW
Storage temperature (T_{ST})	-55 °C to +150 °C
Operating temperature (T_{OP})	-55 °C to +125 °C

Performance is guaranteed only under the conditions listed in the specifications table and is not guaranteed under the full range(s) described by the Absolute Maximum specifications. Exceeding any of the absolute maximum/minimum specifications may result in permanent damage to the device and will void the warranty.

CAUTION: *Although this device is designed to be as robust as possible, ESD (Electrostatic Discharge) can damage this device. This device must be protected at all times from ESD. Static charges may easily produce potentials of several kilovolts on the human body or equipment, which can discharge without detection. Industry-standard ESD precautions must be employed at all times.*

Operating Characteristics at 25°C

Parameter	Symbol	Condition	Min.	Typ.	Max.	Unit
Reverse current	I_R	$V_R = 21\text{ V}$			20	nA
Capacitance	C_{T1}	$V_R = 1\text{ V}, F = 1\text{ MHz}$	17.4		21.2	pF
Capacitance ratio	C_{T1}/C_{T3}	$C_T(1\text{ V})/C_T(3\text{ V})$	1.47		1.76	
Capacitance ratio	C_{T1}/C_{T9}	$C_T(1\text{ V})/C_T(9\text{ V})$	3.7		4.5	
Series resistance	R_S	$V_R = 1\text{ V}, F = 500\text{ MHz}$			0.8	Ω
Breakdown voltage	V_B	$I_R = 10\ \mu\text{A}$	26			V

	
Single	Single
SC-79	SOT-23
SMV1130-079 Marking: Cathode	
SMV1130-079LF Marking: Cathode	SMV1130-001LF Marking: HW1
$L_S = 0.7\text{ nH}$	$L_S = 1.5\text{ nH}$

 LF denotes lead (Pb)-free, RoHS-compliant packaging option as an alternative to our standard tin/lead (Sn/Pb) packaging.

Typical Performance Data

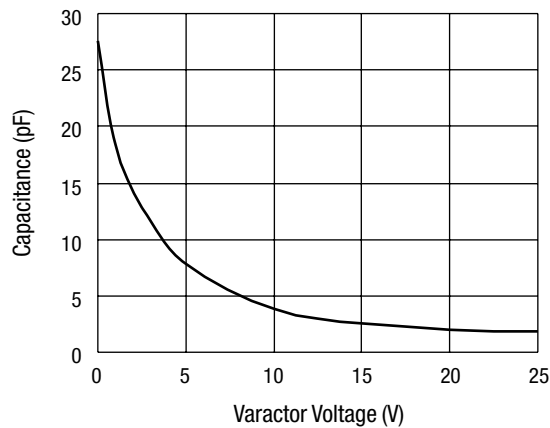

Capacitance vs. Voltage

SPICE Model

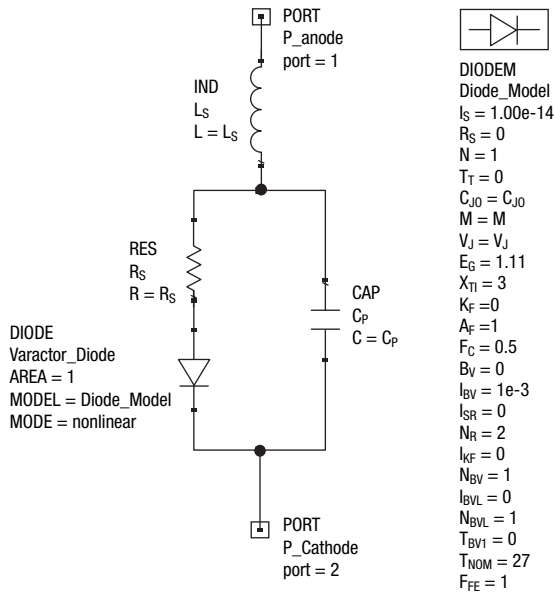

Part Number	C_{J0} (pF)	V_J (V)	M	C_P (pF)	R_S (Ω)	L_S (nH)
SMV1130-079	25.8	10	3.7	1.8	0.8	0.7

Recommended Solder Reflow Profiles

Refer to the [“Recommended Solder Reflow Profile”](#) Application Note.

Tape and Reel Information

Refer to the [“Discrete Devices and IC Switch/Attenuators Tape and Reel Package Orientation”](#) Application Note.

Capacitance vs. Voltage

V_R (V)	C_T (pF)
0	27.6
1	18.5
2.5	12.8
5	7.9
10	3.8
15	2.6
20	2
25	1.8

SC-79

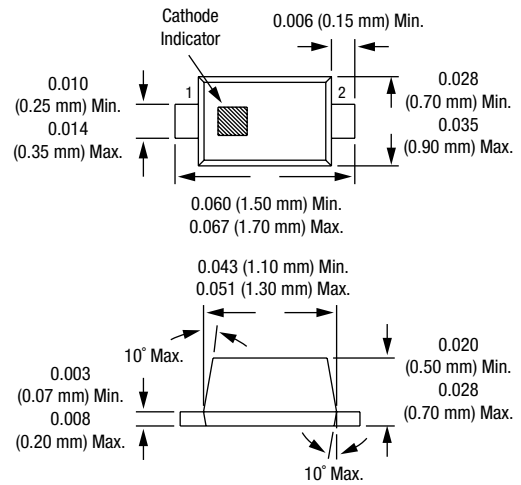

SOT-23

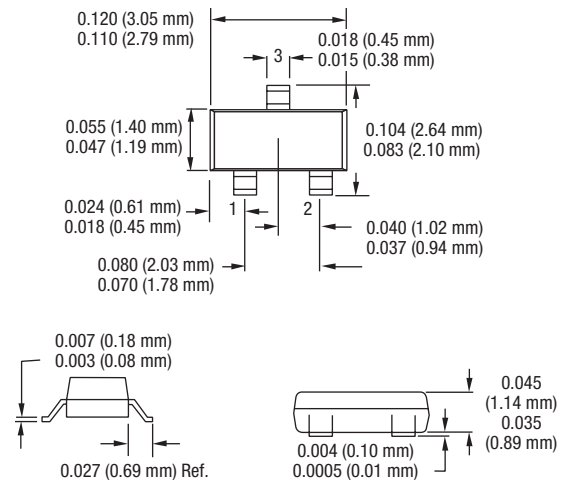

Copyright © 2002, 2003, 2004, 2005, 2006, Skyworks Solutions, Inc. All Rights Reserved.

Information in this document is provided in connection with Skyworks Solutions, Inc. ("Skyworks") products or services. These materials, including the information contained herein, are provided by Skyworks as a service to its customers and may be used for informational purposes only by the customer. Skyworks assumes no responsibility for errors or omissions in these materials or the information contained herein. Skyworks may change its documentation, products, services, specifications or product descriptions at any time, without notice. Skyworks makes no commitment to update the materials or information and shall have no responsibility whatsoever for conflicts, incompatibilities, or other difficulties arising from any future changes.

No license, whether express, implied, by estoppel or otherwise, is granted to any intellectual property rights by this document. Skyworks assumes no liability for any materials, products or information provided hereunder, including the sale, distribution, reproduction or use of Skyworks products, information or materials, except as may be provided in Skyworks Terms and Conditions of Sale.

THE MATERIALS, PRODUCTS AND INFORMATION ARE PROVIDED "AS IS" WITHOUT WARRANTY OF ANY KIND, WHETHER EXPRESS, IMPLIED, STATUTORY, OR OTHERWISE, INCLUDING FITNESS FOR A PARTICULAR PURPOSE OR USE, MERCHANTABILITY, PERFORMANCE, QUALITY OR NON-INFRINGEMENT OF ANY INTELLECTUAL PROPERTY RIGHT; ALL SUCH WARRANTIES ARE HEREBY EXPRESSLY DISCLAIMED. SKYWORKS DOES NOT WARRANT THE ACCURACY OR COMPLETENESS OF THE INFORMATION, TEXT, GRAPHICS OR OTHER ITEMS CONTAINED WITHIN THESE MATERIALS. SKYWORKS SHALL NOT BE LIABLE FOR ANY DAMAGES, INCLUDING BUT NOT LIMITED TO ANY SPECIAL, INDIRECT, INCIDENTAL, STATUTORY, OR CONSEQUENTIAL DAMAGES, INCLUDING WITHOUT LIMITATION, LOST REVENUES OR LOST PROFITS THAT MAY RESULT FROM THE USE OF THE MATERIALS OR INFORMATION, WHETHER OR NOT THE RECIPIENT OF MATERIALS HAS BEEN ADVISED OF THE POSSIBILITY OF SUCH DAMAGE.

Skyworks products are not intended for use in medical, lifesaving or life-sustaining applications, or other equipment in which the failure of the Skyworks products could lead to personal injury, death, physical or environmental damage. Skyworks customers using or selling Skyworks products for use in such applications do so at their own risk and agree to fully indemnify Skyworks for any damages resulting from such improper use or sale.

Customers are responsible for their products and applications using Skyworks products, which may deviate from published specifications as a result of design defects, errors, or operation of products outside of published parameters or design specifications. Customers should include design and operating safeguards to minimize these and other risks. Skyworks assumes no liability for applications assistance, customer product design, or damage to any equipment resulting from the use of Skyworks products outside of stated published specifications or parameters.

Skyworks, the Skyworks symbol, and "Breakthrough Simplicity" are trademarks or registered trademarks of Skyworks Solutions, Inc., in the United States and other countries. Third-party brands and names are for identification purposes only, and are the property of their respective owners. Additional information, including relevant terms and conditions, posted at www.skyworksinc.com, are incorporated by reference.