

Product Description

Stanford Microdevices' SGA-7489 is a high performance cascadeable 50-ohm amplifier designed for operation at 5 Volts DC. This RFIC uses the latest Silicon Germanium Heterostructure Bipolar Transistor (SiGe HBT) process featuring 1 micron emitters with F_T up to 50 GHz.

This circuit uses a darlington pair topology with resistive feedback for broadband performance as well as stability over its entire temperature range. Internally matched to 50 ohm impedance, the SGA-7489 requires only DC blocking and bypass capacitors and a bias inductor for external components. Frequency performance may be extended using the 2 GHz application circuit shown on sheet 5.

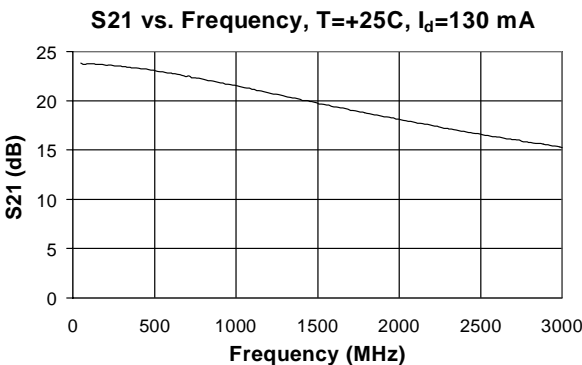

SGA-7489

DC-3000 MHz Silicon Germanium HBT Cascadeable Gain Block



Product Features

- DC-3000 MHz Operation
- Single Voltage Supply
- High Output Intercept: +36 dBm typ. at 850 MHz
- Low Noise Figure: 2.9 dB typ. at 850 MHz

Applications

- Oscillator Amplifiers
- PA for Low / Medium Power Applications
- IF/ RF Buffer Amplifier
- Drivers for CATV Amplifiers
- LO Driver Amplifier

Symbol	Parameters: Test Conditions: Z ₀ = 50 Ohms, I _D = 130 mA, T = 25°C	Units	Min.	Typ.	Max.	Notes
P _{1dB}	Output Power at 1dB Compression	f = 100 MHz dBm f = 500 MHz dBm f = 850 MHz dBm f = 1950 MHz * dBm		22.8 22.6 22.4 20.3*		* Using 2 GHz App.Ckt. (sheet 5)
IP ₃	Third Order Intercept Point Power out per tone = 0 dBm	f = 100 MHz dBm f = 500 MHz dBm f = 850 MHz dBm f = 1950 MHz * dBm		38.6 37.2 36.0 35.7*		* Using 2 GHz App.Ckt. (sheet 5)
S ₂₁	Small Signal Gain	f = 100 MHz dB f = 500 MHz dB f = 850 MHz dB f = 1950 MHz * dB		23.7 23.0 22.0 18.3*		* Using 2 GHz App.Ckt. (sheet 5)
Bandwidth	(Determined by S ₁₁ , S ₂₂ Values)			3000		
S ₁₁	Input Return Loss	f = DC-3000 MHz		11.8		
S ₂₂	Output Return Loss	f = DC-3000 MHz		9.3		
S ₁₂	Reverse Isolation	f = 100 MHz dB f = 500 MHz dB f = 850 MHz dB f = 1950 MHz * dB		25.8 25.8 25.4 22.7*		* Using 2 GHz App.Ckt. (sheet 5)
NF	Noise Figure, Z _S = 50 Ohms	f = 850 MHz		2.9		
V _D	Device Voltage			5.0		
Rth,j-l	Thermal Resistance (junction - lead)		° C/W	82		

The information provided herein is believed to be reliable at press time. Stanford Microdevices assumes no responsibility for inaccuracies or omissions. Stanford Microdevices assumes no responsibility for the use of this information, and all such information shall be entirely at the user's own risk. Prices and specifications are subject to change without notice. No patent rights or licenses to any of the circuits described herein are implied or granted to any third party. Stanford Microdevices does not authorize or warrant any Stanford Microdevices product for use in life-support devices and/or systems. Copyright 2001 Stanford Microdevices, Inc. All worldwide rights reserved.

Absolute Maximum Ratings

Operation of this device above any one of these parameters may cause permanent damage.

Bias Conditions should also satisfy the following expression:

$$I_D V_D (\text{max}) < (T_J - T_{OP})/R_{th, j-l}$$

Parameter	Value	Unit
Supply Current	160 (approx.)	mA
Operating Temperature	-40 to +85	C
Maximum Input Power	+10	dBm
Storage Temperature Range	-40 to +150	C
Operating Junction Temperature	+150	C

Key parameters, at typical operating frequencies:

Parameter	Typical	Unit	Test Condition
	25°C		($I_D = 130$ mA, unless otherwise noted)
100 MHz			
Gain	23.7	dB	$Z_s = 50$ Ohms Tone spacing = 1 MHz, Pout per tone = 0 dBm
Noise Figure	2.7	dB	
Output IP3	38.6	dBm	
Output P1dB	22.8	dBm	
Input Return Loss	15.0	dB	
Reverse Isolation	25.8	dB	
500 MHz			
Gain	23.0	dB	$Z_s = 50$ Ohms Tone spacing = 1 MHz, Pout per tone = 0 dBm
Noise Figure	2.7	dB	
Output IP3	37.2	dBm	
Output P1dB	22.6	dBm	
Input Return Loss	16.2	dB	
Reverse Isolation	25.8	dB	
850 MHz			
Gain	22.0	dB	$Z_s = 50$ Ohms Tone spacing = 1 MHz, Pout per tone = 0 dBm
Noise Figure	2.9	dB	
Output IP3	36.0	dBm	
Output P1dB	22.4	dBm	
Input Return Loss	17.3	dB	
Reverse Isolation	25.4	dB	
1950 MHz			
Gain	18.2	dB	$Z_s = 50$ Ohms Tone spacing = 1 MHz, Pout per tone = 0 dBm
Noise Figure	---	dB	
Output IP3 *	33.3	dBm	
Output P1dB *	19.9	dBm	
Input Return Loss	15.5	dB	
Reverse Isolation	22.9	dB	
2400 MHz			
Gain	16.9	dB	$Z_s = 50$ Ohms Tone spacing = 1 MHz, Pout per tone = 0 dBm
Noise Figure	---	dB	
Output IP3 *	31.9	dBm	
Output P1dB *	18.9	dBm	
Input Return Loss	13.8	dB	
Reverse Isolation	21.7	dB	

* NOTE: P1dB and IP3 @1950,2400 MHz may be improved by using the tuned circuit shown on sheet 5

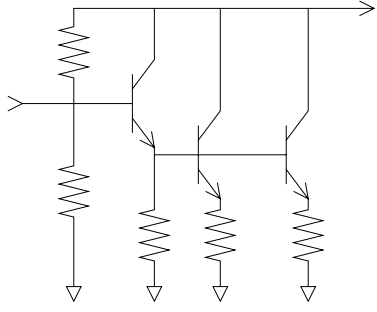
Pin #	Function	Description	Device Schematic
1	RF IN	RF input pin. This pin requires the use of an external DC blocking capacitor chosen for the frequency of operation.	
2	GND	Connection to ground. Use via holes for best performance to reduce lead inductance. Place vias as close to ground leads as possible.	
3	RF OUT/Vcc	RF output and bias pin. Bias should be supplied to this pin through an external series resistor and RF choke inductor. Because DC biasing is present on this pin, a DC blocking capacitor should be used in most applications (see application schematic). The supply side of the bias network should be well bypassed.	
4	GND	Same as Pin 2.	

Recommended Bias Resistor Values			
Supply Voltage(Vs)	7V	8V	9V
Rbias (Ohms)	15	22	30
Power Rating (W)	0.5	0.5	1.0

Application Circuit Component Description	Choose circuit components such that the following conditions are met at the minimum operational frequency:
Bias Inductor	$X_{Lb} \geq 250 \text{ Ohms}$
Input / Output Coupling Capacitors	$X_{Cc} \leq 10 \text{ Ohms}$
Decoupling Capacitors	$X_{Cd} \leq 1 \text{ Ohm}$

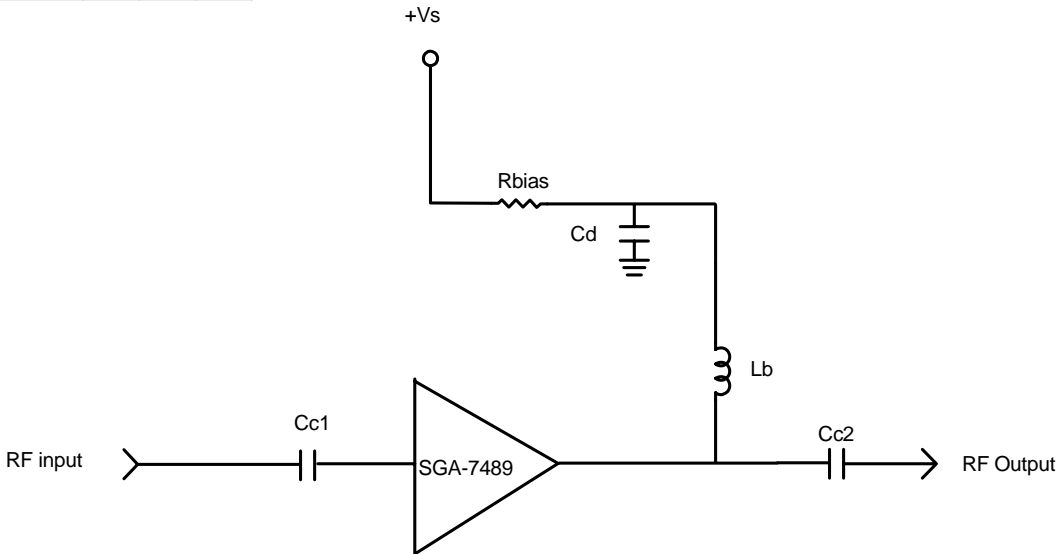

SGA-7489 Basic Application Circuit

S-Parameter Data @ -40C,+25C,+85C , $I_d = 130$ mA

S21 vs. Freq. @ -40C,+25C,+85C

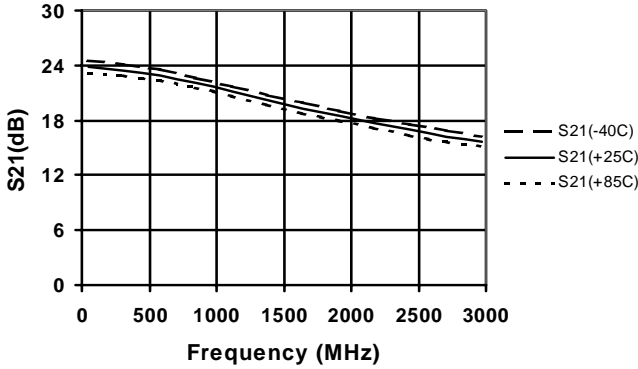

S11 vs. Freq. @ -40C,+25C,+85C

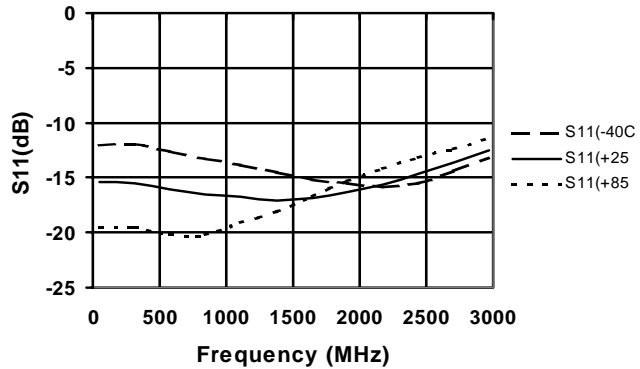

S12 vs. Freq. @ -40C,+25C,+85C

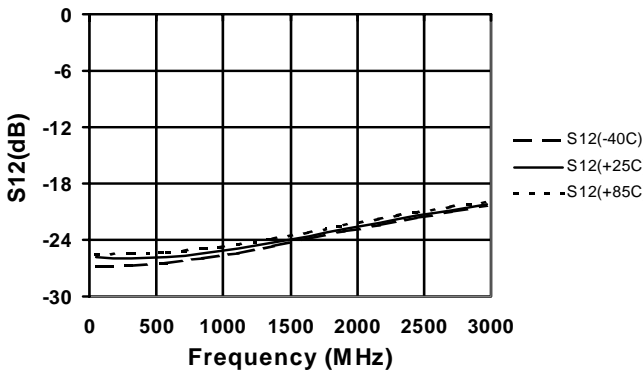

S22 vs. Freq. @ -40C,+25C,+85C

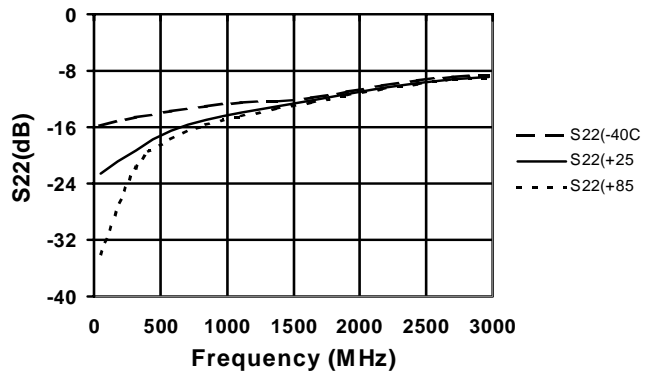

P1dB & IP3 vs. Frequency @ 3 Temps. $I_d = 130$ mA

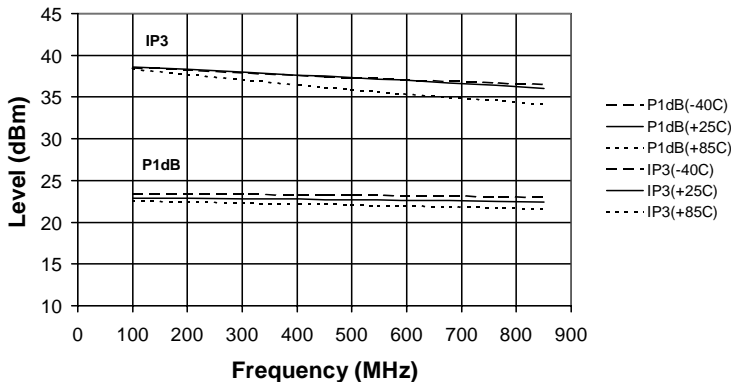

2 GHz Application Ckt. Board

The SGA-7489 may be tuned in the manner shown below for operation at 2 GHz.

Component Parts List

Component Type	Value	Manufacturer	P/N
Cc1, Cc2, Cd1	100 pF	ROHM	MCH185A101JK
CM1	1.2 pF	ROHM	MCH185A1R2JK
CM2	1.5 pF	ROHM	MCH185A1R5JK
Cd2	0.1 uF	ROHM	MCH182FN1042K
Lb	22 nH	TOKO	LL1608FS22NJ
Rb1, Rb2	30 Ohms, 1/4	ROHM	Type MRC 18

Table of Delay Elements

Ref. Desig.	Zo (Ohms)	Phase Delay @ 2 GHz (Degrees)
Z1	50	14.5
Z2	50	34.1
Z3	50	21.5

Note: Separation Distance between via holes on board represents approx. 5.4 Degrees phase shift @ 2GHz for equivalent distance on microstrip.

Board material is GETEK, $\epsilon = 4.1$

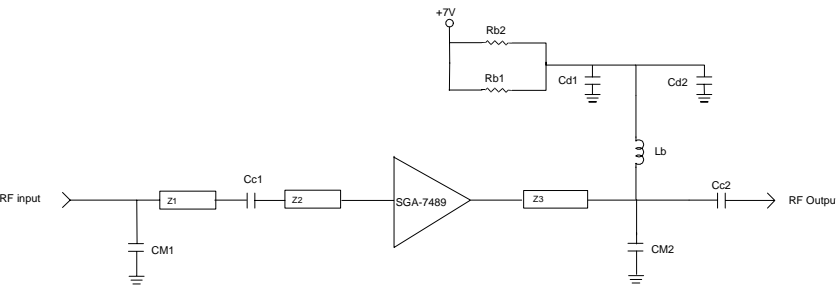
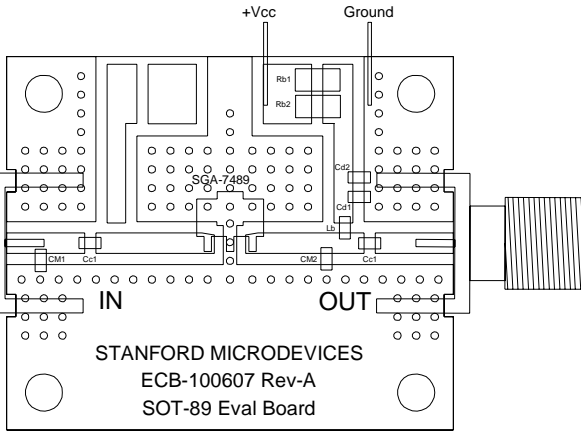

SGA-7489 2 GHz Application Circuit

SGA-7489 2 GHz Tuned Application Ckt. Summary Data Table

Parameter	Typical	Test Condition	
	25°C	Unit	($I_D = 130$ mA, unless otherwise noted)
1700 MHz			
Gain	18.6	dB	$Z_s = 50$ Ohms Tone spacing = 1 MHz, Pout per tone = 0 dBm
Noise Figure	3.1	dB	
Output IP3	36.1	dBm	
Output P1dB	20.8	dBm	
Input Return Loss	10.0	dB	
Reverse Isolation	23.8	dB	
1900 MHz			
Gain	18.3	dB	$Z_s = 50$ Ohms Tone spacing = 1 MHz, Pout per tone = 0 dBm
Noise Figure	3.3	dB	
Output IP3	36.0	dBm	
Output P1dB	20.4	dBm	
Input Return Loss	11.2	dB	
Reverse Isolation	23.0	dB	
2100 MHz			
Gain	18.2	dB	$Z_s = 50$ Ohms Tone spacing = 1 MHz, Pout per tone = 0 dBm
Noise Figure	3.7	dB	
Output IP3	34.5	dBm	
Output P1dB	19.9	dBm	
Input Return Loss	16.3	dB	
Reverse Isolation	22.1	dB	

Gain vs. Frequency for 2GHz Tuned Circuit, $I_d = 130$ mA, $T = +25^\circ\text{C}$

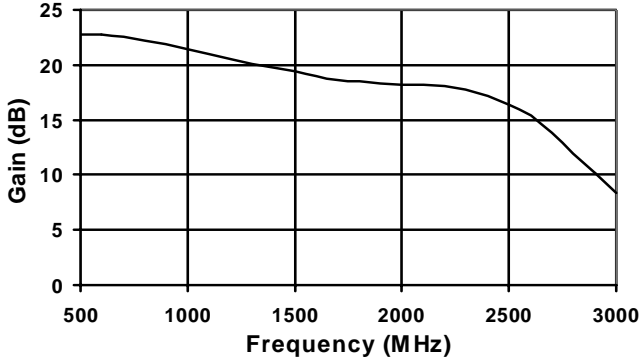

P1dB & IP3 vs. Frequency for 2GHz Tuned Circuit, $I_d = 130$ mA, $T = +25^\circ\text{C}$

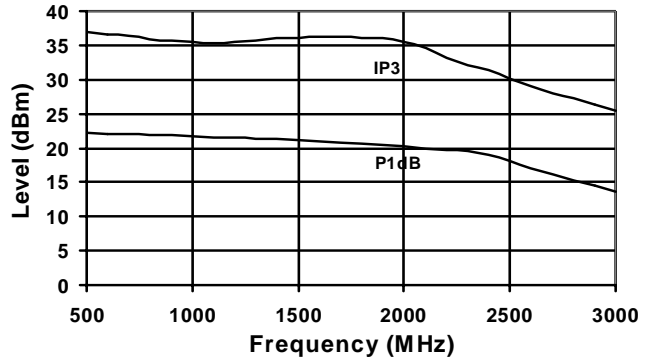

S-Parameter Data for 2 GHz Tuned Application Circuit

S21 vs. Frequency, $I_d = 130$ mA, $T = +25^\circ\text{C}$

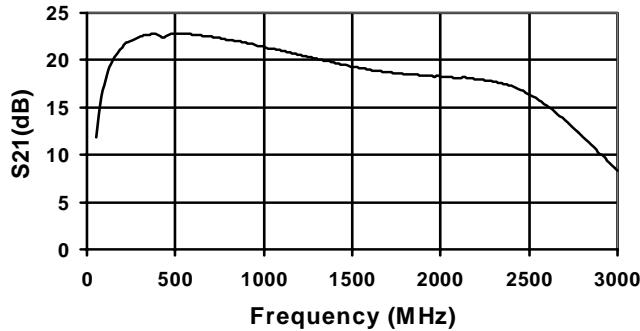

S11 vs. Frequency, $I_d = 130$ mA, $T = +25^\circ\text{C}$

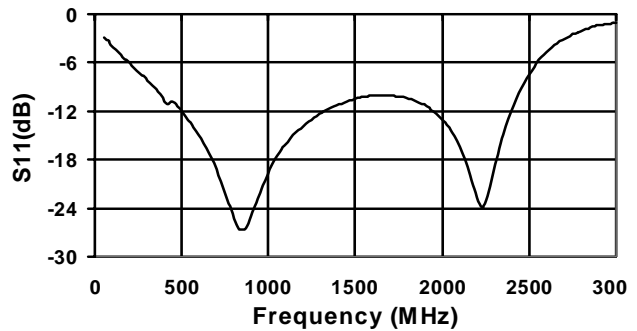

S12 vs. Frequency, $I_d = 130$ mA, $T = +25^\circ\text{C}$

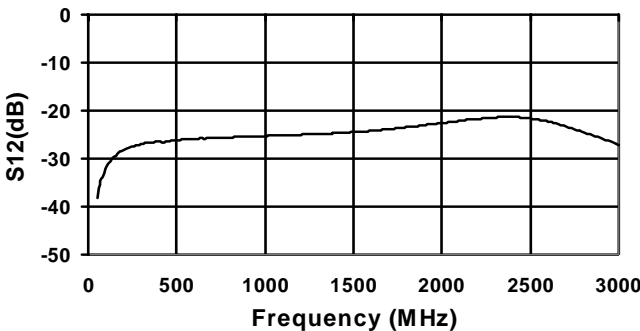

S22 vs. Frequency, $I_d = 130$ mA, $T = +25^\circ\text{C}$

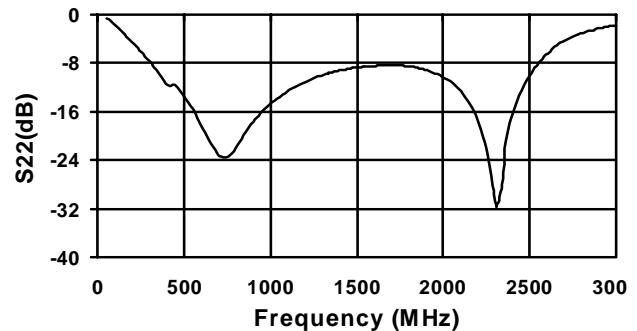

**Noise Figure vs. Frequency for SGA-7489 2GHz
Tuned Circuit , $I_d=130$ mA, $T=+25C$**

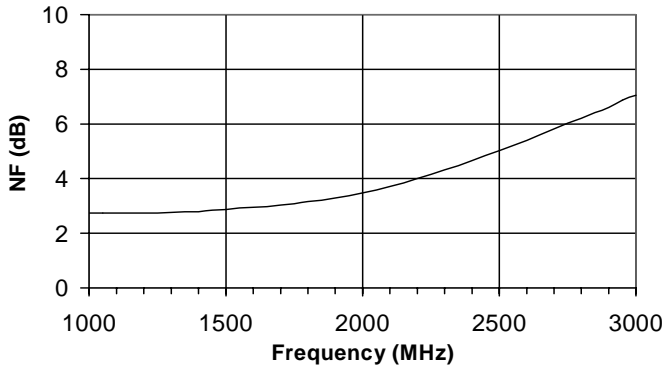

**I_d vs. V_d Variation over Temperature for
 $V_s=7$ Volts and $R_{bias} = 15$ Ohms for SGA-7489**

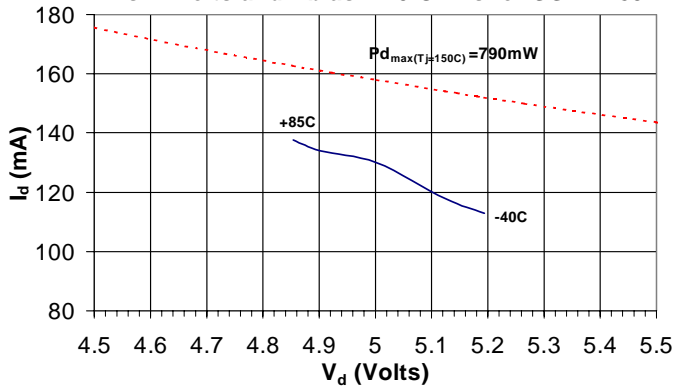

Plot of V_d vs. Temp. @ $I_d=130$ mA (no signal)

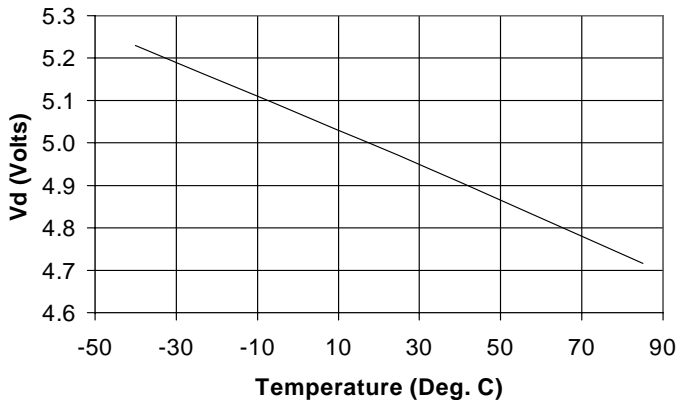



Caution: ESD sensitive
 Appropriate precautions in handling, packaging and testing devices must be observed.

Part Number Ordering Information

Part Number	Reel Size	Devices/Reel
SGA-7489	13"	3000

Part Symbolization

The part will be symbolized with "A74" designator on the top surface of the package.

Package Dimensions

Pin #	Function
1	RFin
2	Gnd
3	RFout/Vcc
4	Gnd

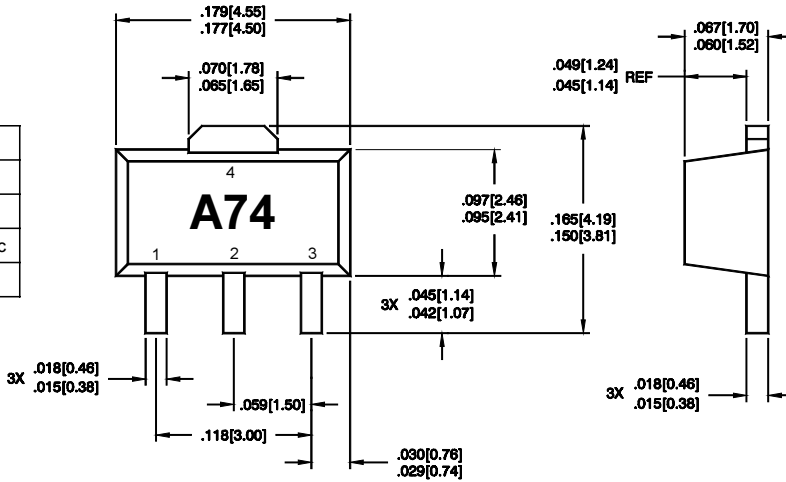

Pin assignments shown for reference only, not marked on part

PCB Pad Layout

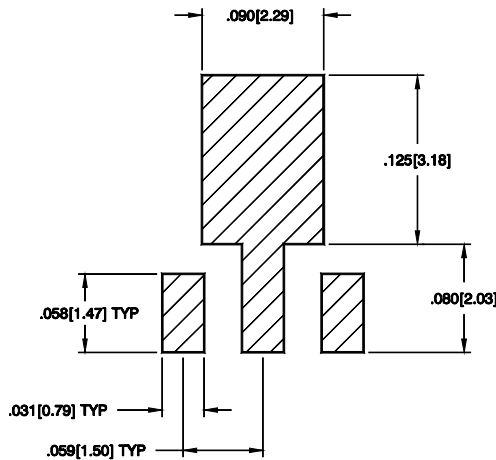

DIMENSIONS ARE IN INCHES [MM]