

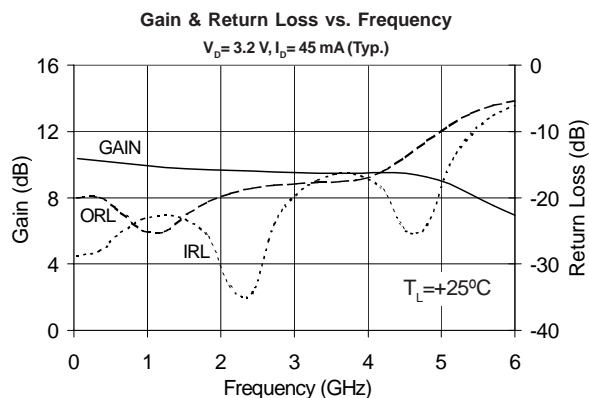

Product Description

The SGA-4163 is a high performance SiGe HBT MMIC Amplifier. A Darlington configuration featuring 1 micron emitters provides high F_T and excellent thermal performance. The heterojunction increases breakdown voltage and minimizes leakage current between junctions. Cancellation of emitter junction non-linearities results in higher suppression of intermodulation products. Only 2 DC-blocking capacitors, a bias resistor and an optional RF choke are required for operation.

The matte tin finish on Sirenza's lead-free package utilizes a post annealing process to mitigate tin whisker formation and is RoHS compliant per EU Directive 2002/95. This package is also manufactured with green molding compounds that contain no antimony trioxide nor halogenated fire retardants.



Symbol	Parameter	Units	Frequency	Min.	Typ.	Max.
G	Small Signal Gain	dB	850 MHz 1950 MHz 2400 MHz	9.5	10.5 9.7 9.6	11.5
P_{1dB}	Output Power at 1dB Compression	dBm	850 MHz 1950 MHz		13.0 12.1	
OIP_3	Output Third Order Intercept Point	dBm	850 MHz 1950 MHz		29.7 25.4	
Bandwidth	Determined by Return Loss (>10dB)	MHz			5000	
IRL	Input Return Loss	dB	1950 MHz		28.0	
ORL	Output Return Loss	dB	1950 MHz		20.1	
NF	Noise Figure	dB	1950 MHz		5.0	
V_D	Device Operating Voltage	V		2.9	3.2	3.5
I_D	Device Operating Current	mA		41	45	49
$R_{TH}, j-l$	Thermal Resistance (junction to lead)	$^\circ\text{C}/\text{W}$			255	
Test Conditions: $V_S = 8 \text{ V}$ $I_D = 45 \text{ mA Typ.}$ OIP_3 Tone Spacing = 1 MHz, P_{out} per tone = -5 dBm $R_{BIAS} = 110 \text{ Ohms}$ $T_L = 25^\circ\text{C}$ $Z_S = Z_L = 50 \text{ Ohms}$						

SGA-4163

SGA-4163Z RoHS Compliant & Green Package

**DC-5000 MHz, Cascadable
SiGe HBT MMIC Amplifier**



Product Features

- Now available in Lead Free, RoHS Compliant, & Green Packaging
- Broadband Operation: DC-5000 MHz
- Cascadable 50 Ohm
- Operates From Single Supply
- Low Thermal Resistance Package

Applications

- PA Driver Amplifier
- Cellular, PCS, GSM, UMTS
- IF Amplifier
- Wireless Data, Satellite

Typical RF Performance at Key Operating Frequencies

Symbol	Parameter	Unit	Frequency (MHz)					
			100	500	850	1950	2400	3500
G	Small Signal Gain	dB	10.3	10.2	10.5	9.7	9.6	9.4
OIP ₃	Output Third Order Intercept Point	dBm		30.2	29.7	25.4	23.0	
P _{1dB}	Output Power at 1dB Compression	dBm		12.9	13.0	12.1	11.1	
IRL	Input Return Loss	dB	29.1	26.7	23.7	28.0	36.7	16.6
ORL	Output Return Loss	dB	19.7	20.8	24.3	20.1	18.7	17.6
S ₁₂	Reverse Isolation	dB	15.5	16.0	16.3	17.2	17.6	18.4
NF	Noise Figure	dB		4.6	4.8	5.0	5.3	

Test Conditions: V_S = 8 V, I_D = 45 mA Typ., OIP₃ Tone Spacing = 1 MHz, Pout per tone = -5 dBm
R_{BIAS} = 110 Ohms, T_L = 25°C, Z_S = Z_L = 50 Ohms

Noise Figure vs. Frequency
V_D = 3.2 V, I_D = 45 mA (Typ.)

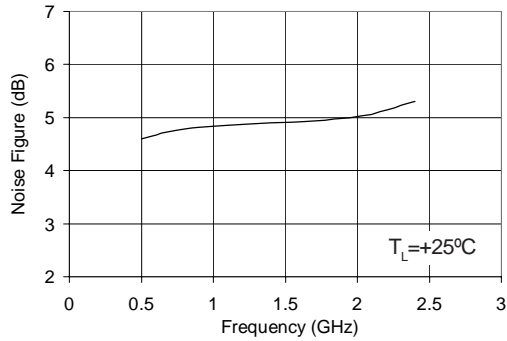

Absolute Maximum Ratings

Parameter	Absolute Limit
Max. Device Current (I _D)	90 mA
Max. Device Voltage (V _D)	5 V
Max. RF Input Power	+18 dBm
Max. Junction Temp. (T _J)	+150°C
Operating Temp. Range (T _L)	-40°C to +85°C
Max. Storage Temp.	+150°C

Operation of this device beyond any one of these limits may cause permanent damage. For reliable continuous operation, the device voltage and current must not exceed the maximum operating values specified in the table on page one.
Bias conditions should also satisfy the following expression:
 $I_D V_D < (T_J - T_L) / R_{thj} \text{ J}^{-1}$

OIP₃ vs. Frequency
V_D = 3.2 V, I_D = 45 mA (Typ.)

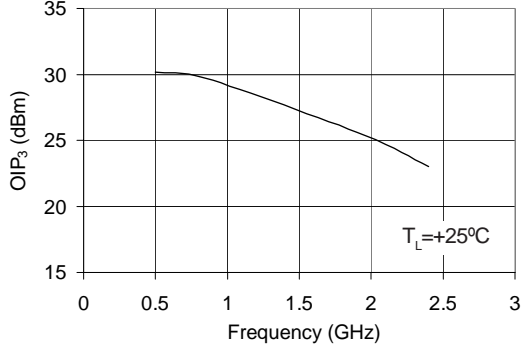

P_{1dB} vs. Frequency
V_D = 3.2 V, I_D = 45 mA (Typ.)

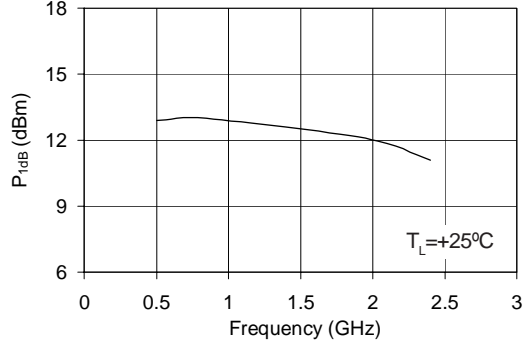

Typical RF Performance Over Temperature (Bias: $V_D = 3.2\text{ V}$, $I_D = 45\text{ mA}$ (Typ.))

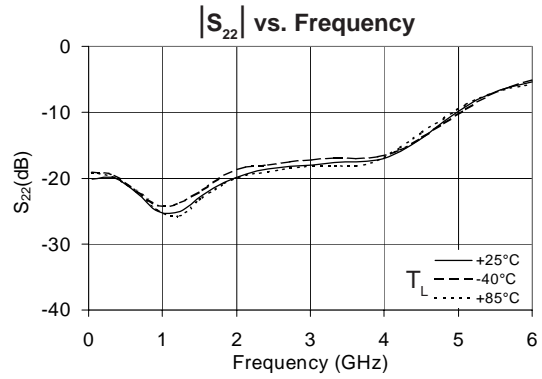
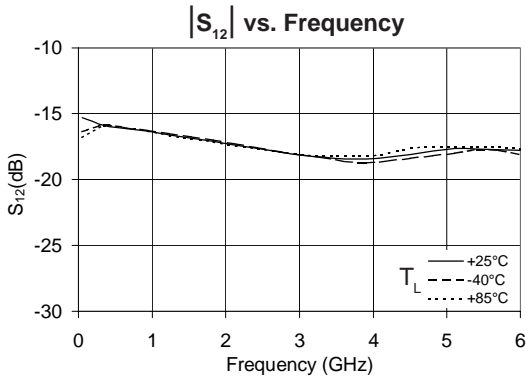
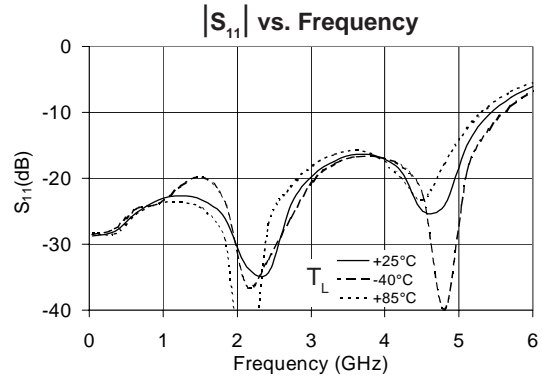
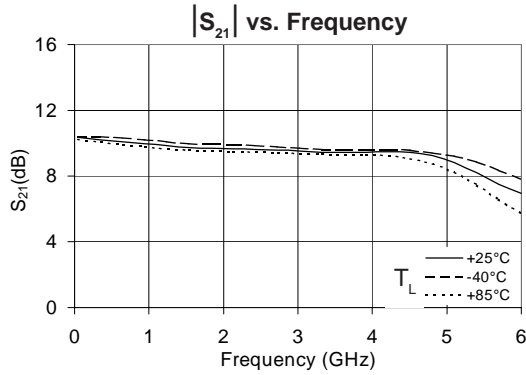

NOTE: Full S-parameter data available at www.sirenza.com

Basic Application Circuit

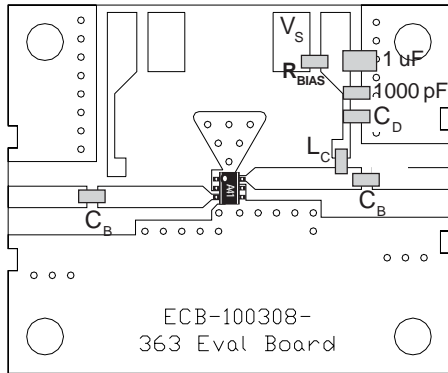
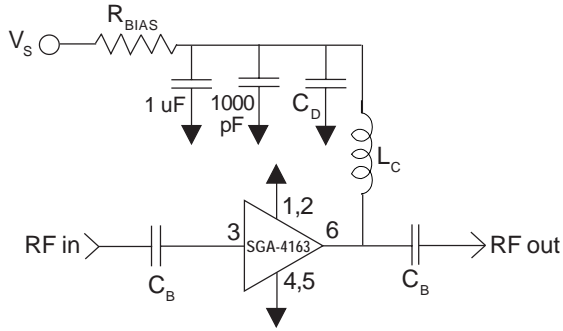

Part Identification Marking

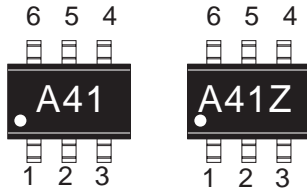

Caution: ESD sensitive
Appropriate precautions in handling, packaging and testing devices must be observed.

Application Circuit Element Values

Reference Designator	Frequency (Mhz)				
	500	850	1950	2400	3500
C _B	220 pF	100 pF	68 pF	56 pF	39 pF
C _D	100 pF	68 pF	22 pF	22 pF	15 pF
L _C	68 nH	33 nH	22 nH	18 nH	15 nH

Recommended Bias Resistor Values for I_D=45mA
 $R_{BIAS} = (V_S - V_D) / I_D$

Supply Voltage (V _S)	6 V	8 V	10 V	12 V
R _{BIAS}	62 Ω	110 Ω	150 Ω	200 Ω

Note: R_{BIAS} provides DC bias stability over temperature.

Mounting Instructions

1. Use a large ground pad area near device pins 1, 2, 4, and 5 with many plated through-holes as shown.
3. We recommend 1 or 2 ounce copper. Measurements for this data sheet were made on a 31 mil thick FR-4 board with 1 ounce copper on both sides.

Pin #	Function	Description
3	RF IN	RF input pin. This pin requires the use of an external DC blocking capacitor chosen for the frequency of operation.
1, 2, 4, 5	GND	Connection to ground. For optimum RF performance, use via holes as close to ground leads as possible to reduce lead inductance.
6	RF OUT/BIAS	RF output and bias pin. DC voltage is present on this pin, therefore a DC blocking capacitor is necessary for proper operation.

Part Number Ordering Information

Part Number	Reel Size	Devices/Reel
SGA-4163	7"	3000
SGA-4163Z	7"	3000

SOT-363 PCB Pad Layout

Dimensions in inches [millimeters]

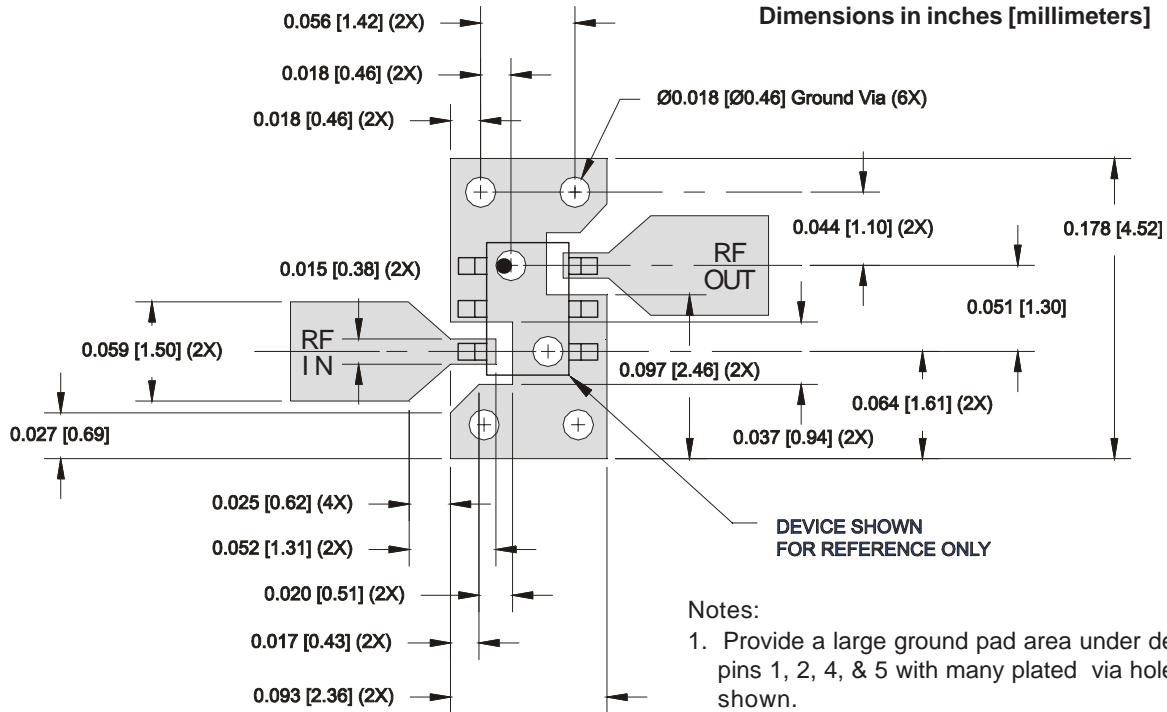

DEVICE SHOWN FOR REFERENCE ONLY

- Notes:
1. Provide a large ground pad area under device pins 1, 2, 4, & 5 with many plated via holes as shown.
 2. Dimensions given for 50 Ohm RF I/O lines are for 31 mil thick Getek. Scale accordingly for different board thicknesses and dielectric constants.
 3. We recommend 1 or 2 ounce copper. Measurements for this data sheet were made on a 31 mil thick Getek with 1 ounce copper on both sides.

SOT-363 Nominal Package Dimensions

Dimensions in inches [millimeters]

A link to the SOT-363 package outline drawing with full dimensions and tolerances may be found on the product web page at www.sirenza.com.

