



FDP5800

N-Channel Logic Level PowerTrench® MOSFET

60V, 80A, 6mΩ

Features

- $R_{DS(on)} = 4.6m\Omega$ (Typ.), $V_{GS} = 10V$, $I_D = 80A$
- High performance trench technology for extremely low R_{Dson}
- Low gate Charge
- High power and current handling capability
- RoHs Compliant



Applications

- Motor/ Body Load Control
- Power Train Management
- Injection Systems
- DC-AC Converters and UPS

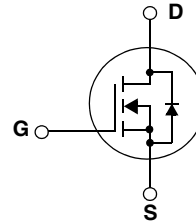
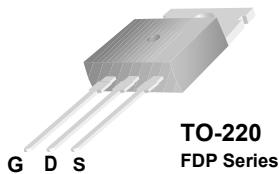

MOSFET Maximum Ratings $T_C = 25^\circ C$ unless otherwise noted*

Symbol	Parameter	Ratings	Units
V_{DSS}	Drain-Source Voltage	60	V
V_{GSS}	Gate-Source Voltage	± 20	V
I_D	Drain Current	-Continuous ($T_C = 25^\circ C$)	80
		-Continuous ($T_C = 100^\circ C$)	80*
		-Continuous ($T_A = 25^\circ C$)	14
I_{DM}	Drain Current - Pulsed	320	A
E_{AS}	Single Pulsed Avalanche Energy (Note 1)	652	mJ
P_D	Power Dissipation ($T_C = 25^\circ C$) - Derate above $25^\circ C$	242	W
		1.61	W/ $^\circ C$
T_J, T_{STG}	Operating and Storage Temperature Range	-55 to +175	$^\circ C$

*Drain current limited by package

Thermal Characteristics

$R_{\theta JC}$	Thermal Resistance, Junction to Case	0.62	$^\circ C/W$
$R_{\theta JA}$	Thermal Resistance, Junction to Ambient, 1in ² copper pad area	43	$^\circ C/W$
$R_{\theta JA}$	Thermal Resistance, Junction to Ambient	62.5	$^\circ C/W$

Package Marking and Ordering Information

Device Marking	Device	Package	Reel Size	Tape Width	Quantity
FDP5800	FDP5800	TO220	--	--	50

Electrical Characteristics $T_C = 25^\circ\text{C}$ unless otherwise noted

Symbol	Parameter	Conditions	Min	Typ	Max	Units
--------	-----------	------------	-----	-----	-----	-------

Off Characteristics

B_{VDSS}	Drain-Source Breakdown Voltage	$I_D = 250\mu\text{A}$, $V_{GS} = 0\text{V}$, $T_J = 25^\circ\text{C}$	60	--	--	V
I_{DSS}	Zero Gate Voltage Drain Current	$V_{DS} = 48\text{V}$ $V_{GS} = 0\text{V}$ $T_J = 150^\circ\text{C}$	--	--	1	μA
I_{GSS}	Gate-Body Leakage Current, Forward	$V_{GS} = \pm 20\text{V}$, $V_{DS} = 0\text{V}$	--	--	± 100	nA

On Characteristics

$V_{GS(th)}$	Gate Threshold Voltage	$V_{GS} = V_{DS}$, $I_D = 250\mu\text{A}$	1.0	--	2.5	V
$R_{DS(on)}$	Static Drain-Source On Resistance	$V_{GS} = 10\text{V}$, $I_D = 80\text{A}$	--	4.6	6.0	m Ω
		$V_{GS} = 4.5\text{V}$, $I_D = 80\text{A}$	--	5.9	7.2	m Ω
		$V_{GS} = 5\text{V}$, $I_D = 80\text{A}$	--	5.6	7.0	m Ω
		$V_{GS} = 10\text{V}$, $I_D = 80\text{A}$ $T_J = 175^\circ\text{C}$	--	10.4	12.6	m Ω

Dynamic Characteristics

C_{iss}	Input Capacitance	$V_{DS} = 15\text{V}$, $V_{GS} = 0\text{V}$ $f = 1\text{MHz}$	--	6890	9160	pF	
C_{oss}	Output Capacitance		--	750	1000	pF	
C_{rss}	Reverse Transfer Capacitance		--	295	445	pF	
R_G	Gate Resistance	$V_{GS} = 0.5\text{V}$, $f = 1\text{MHz}$	--	1.2	--	Ω	
$Q_{g(TOT)}$	Total Gate Charge at 10V	$V_{GS} = 0\text{V}$ to 10V	$V_{DS} = 30\text{V}$ $I_D = 80\text{A}$ $I_g = 1\text{mA}$	--	112	145	nC
$Q_{g(TH)}$	Total Gate Charge at 5V	$V_{GS} = 0\text{V}$ to 5V		--	58	--	nC
$Q_{g(TH)}$	Threshold Gate Charge	$V_{GS} = 0\text{V}$ to 1V		--	7.0	--	nC
Q_{gs}	Gate to Source Gate Charge			--	23	--	nC
Q_{gs2}	Gate Charge Threshold to Plateau			--	13	--	nC
Q_{gd}	Gate to Drain "Miller" Charge			--	18	--	nC

Switching Characteristics ($V_{GS} = 10\text{V}$)

t_{ON}	Turn-On Time	$V_{DD} = 30\text{V}$, $I_D = 80\text{A}$ $V_{GS} = 10\text{V}$, $R_{GEN} = 1.5\Omega$	--	37	85	ns
$t_{d(on)}$	Turn-On Delay Time		--	18	46	ns
t_r	Turn-On Rise Time		--	19	47	ns
$t_{d(off)}$	Turn-Off Delay Time		--	55	120	ns
t_f	Turn-Off Fall Time		--	9	28	ns
t_{OFF}	Turn-Off Time		--	64	138	ns

Drain-Source Diode Characteristics

V_{SD}	Drain-Source Diode Forward Voltage	$V_{GS} = 0\text{V}$, $I_{SD} = 80\text{A}$	--	--	1.25	V
		$V_{GS} = 0\text{V}$, $I_{SD} = 40\text{A}$	--	--	1.0	V
t_{rr}	Reverse Recovery Time	$V_{GS} = 0\text{V}$, $I_{SD} = 60\text{A}$	--	58	--	ns
Q_{rr}	Reverse Recovery Charge	$di_f/dt = 100\text{A}/\mu\text{s}$	--	106	--	nC

Notes:

1: $L = 1\text{mH}$, $I_{AS} = 36\text{A}$, $V_{DD} = 54\text{V}$, $V_{GS} = 10\text{V}$, $R_G = 25\Omega$, Starting $T_J = 25^\circ\text{C}$

Typical Performance Characteristics

Figure 1. On-Region Characteristics

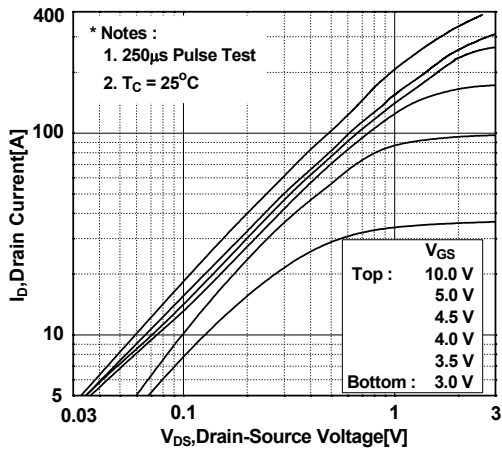

Figure 3. On-Resistance Variation vs. Drain Current and Gate Voltage

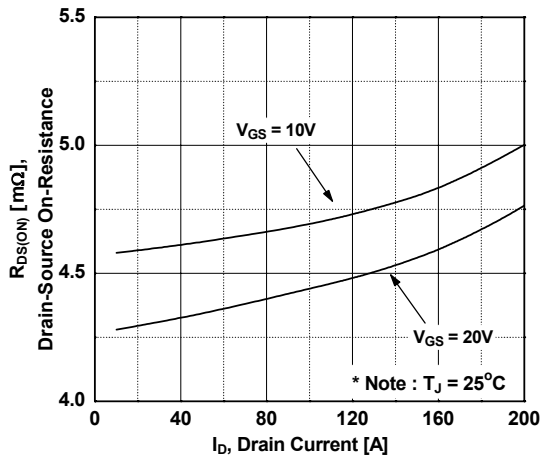

Figure 5. Capacitance Characteristics

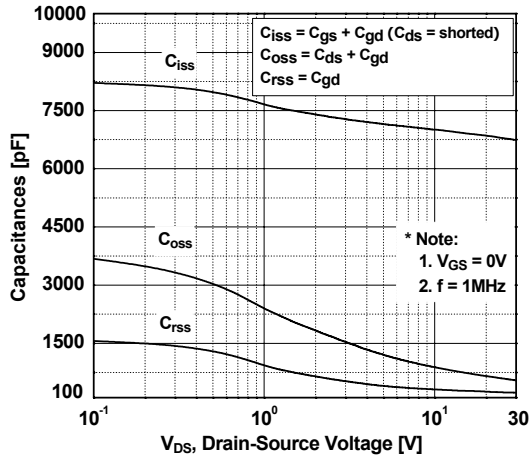

Figure 2. Transfer Characteristics

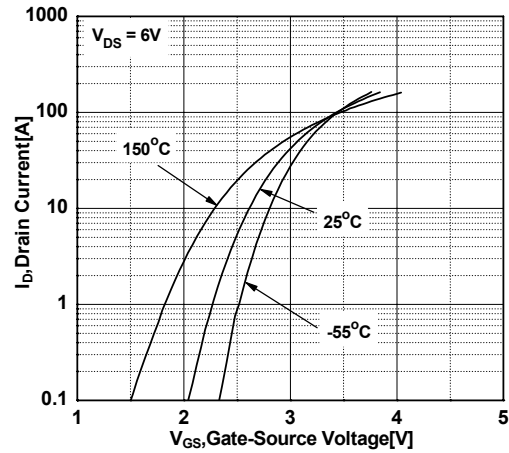

Figure 4. Body Diode Forward Voltage Variation vs. Source Current and Temperature

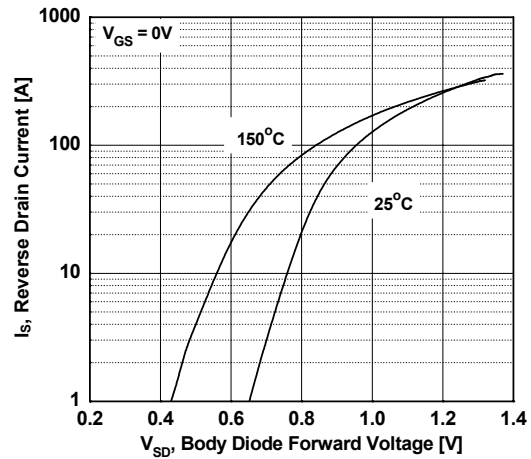
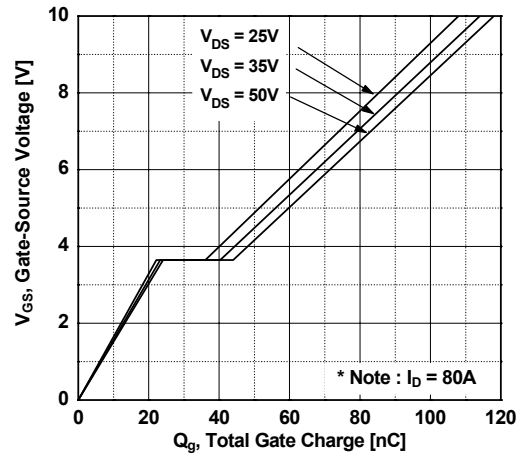

Figure 6. Gate Charge Characteristics



Typical Performance Characteristics (Continued)

Figure 7. Breakdown Voltage Variation vs. Temperature

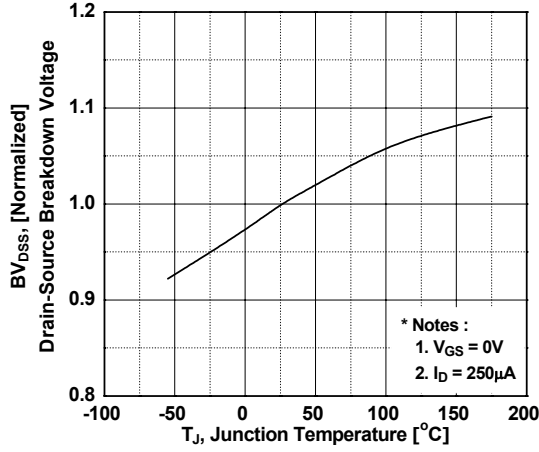

Figure 8. On-Resistance Variation vs. Temperature

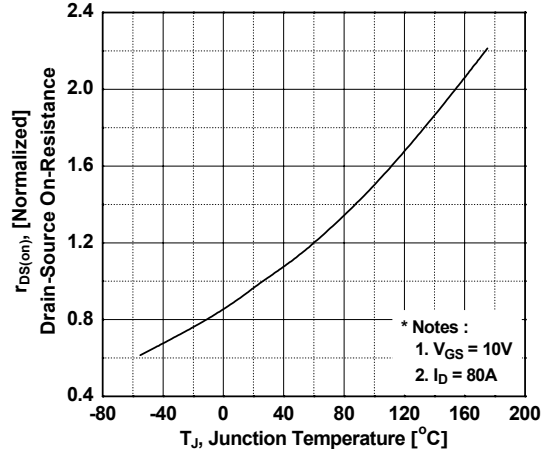

Figure 9. Maximum Safe Operating Area

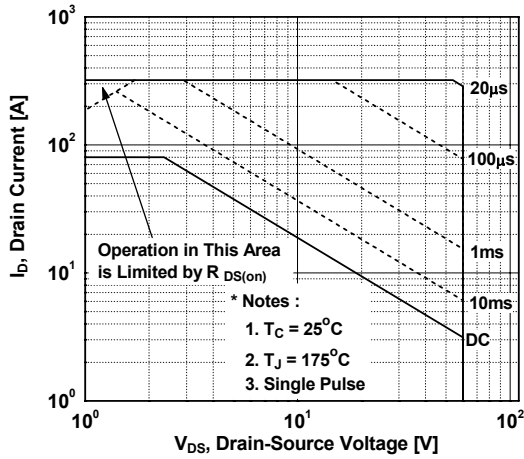

Figure 10. Maximum Drain Current vs. Case Temperature

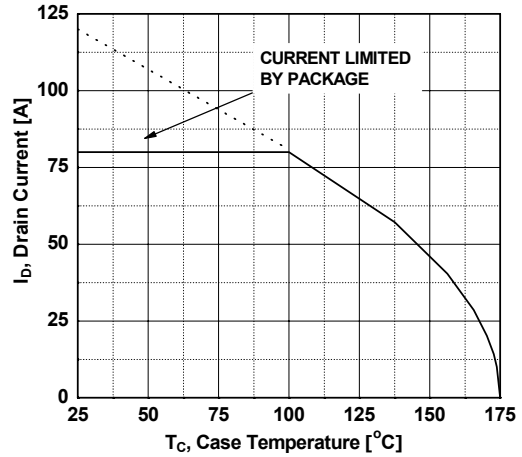
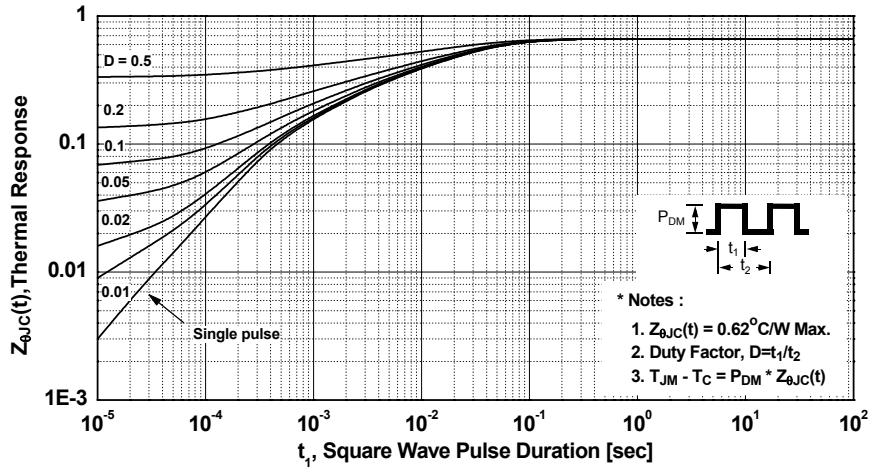
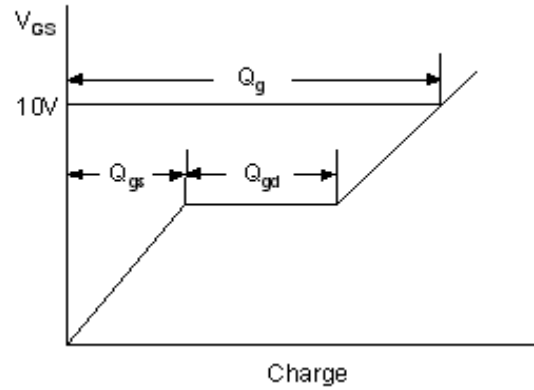
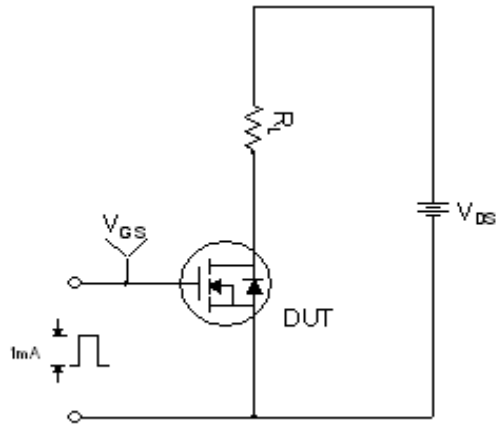

Figure 11. Transient Thermal Response Curve



Gate Charge Test Circuit & Waveform



Resistive Switching Test Circuit & Waveforms

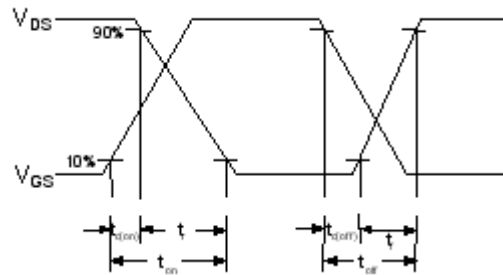
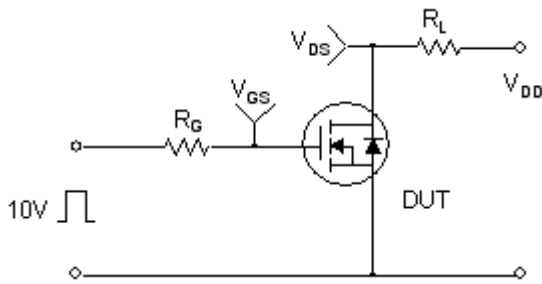

Unclamped Inductive Switching Test Circuit & Waveforms

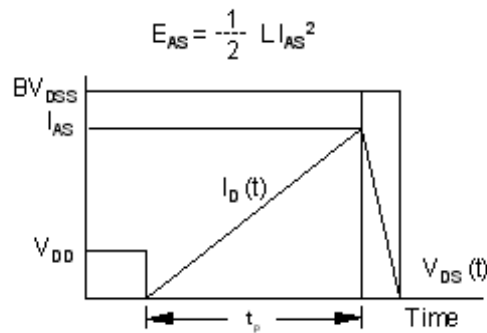
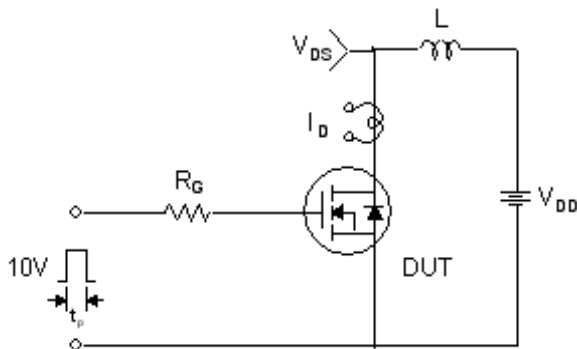

Peak Diode Recovery dv/dt Test Circuit & Waveforms

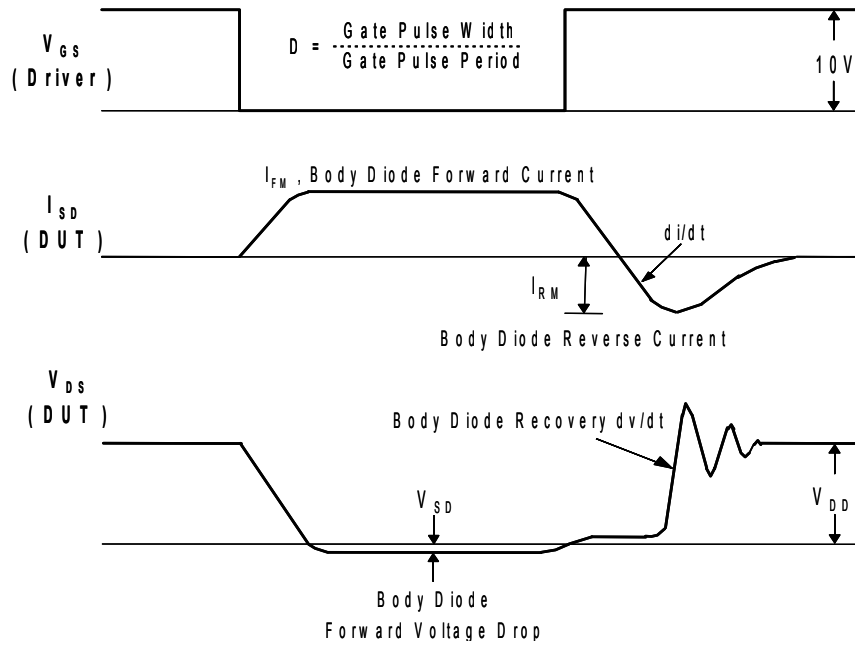
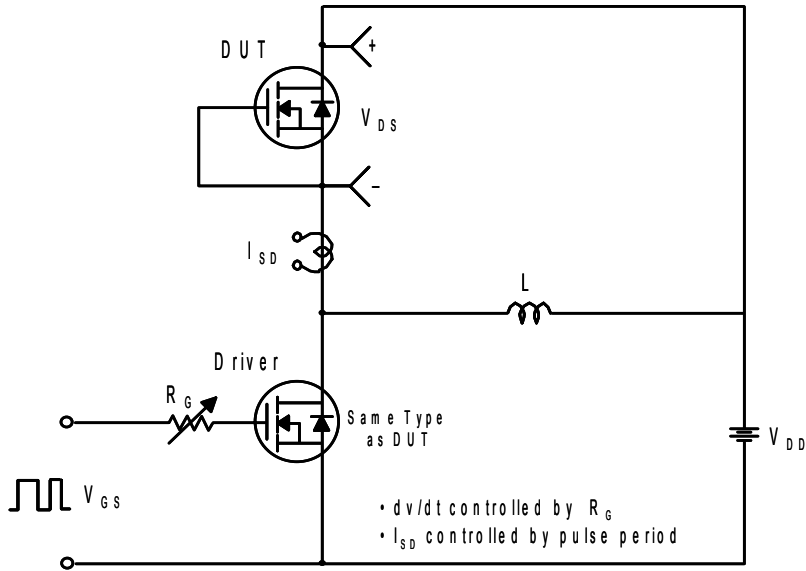

Mechanical Dimensions

TO-220

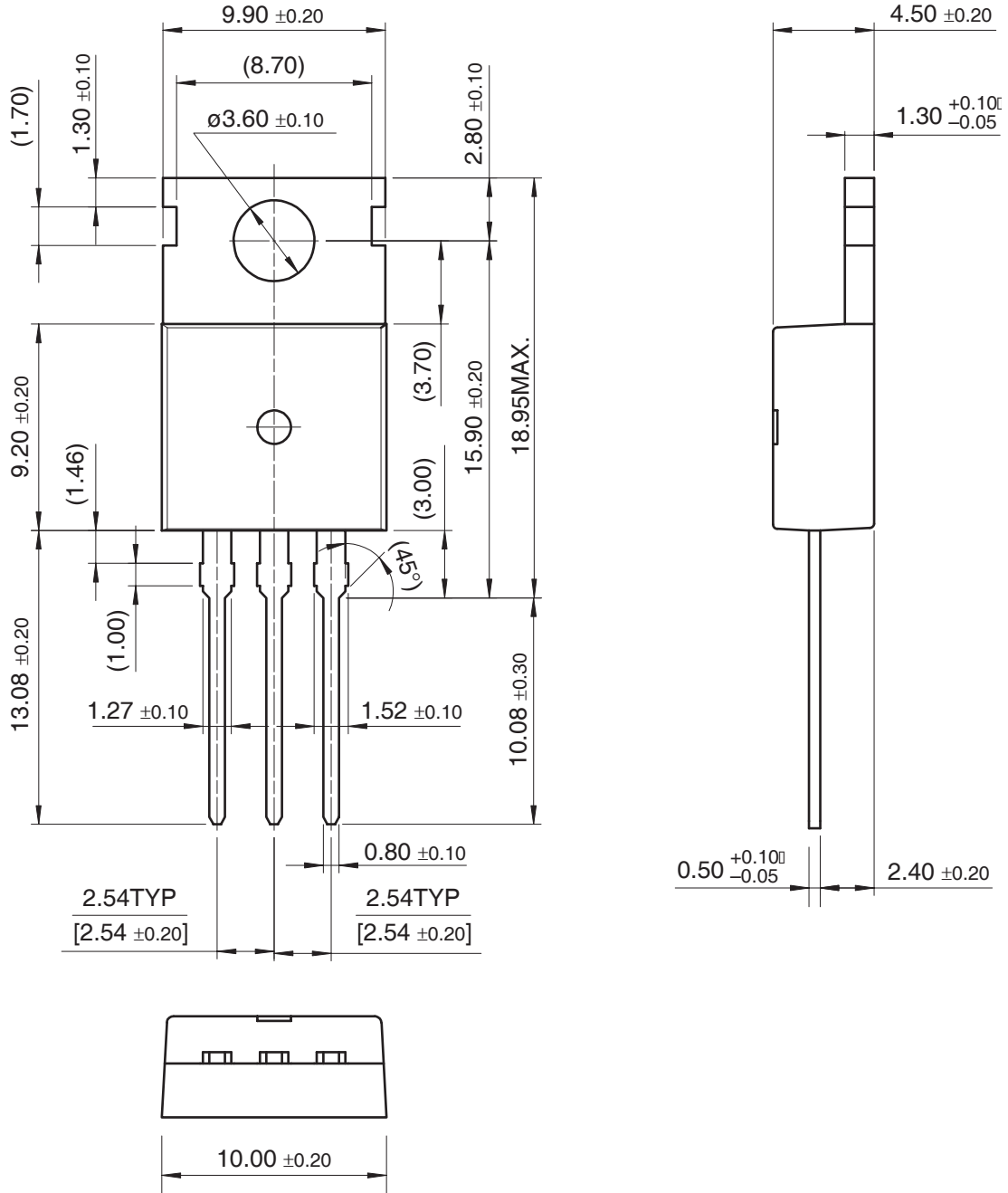

FDP5800 N-Channel Logic Level PowerTrench[®] MOSFET

TRADEMARKS

The following are registered and unregistered trademarks Fairchild Semiconductor owns or is authorized to use and is not intended to be an exhaustive list of all such trademarks.

ACEx™	FACT Quiet Series™	OCX™	SILENT SWITCHER®	UniFET™
ActiveArray™	GlobalOptoisolator™	OCXPro™	SMART START™	UltraFET®
Bottomless™	GTO™	OPTOLOGIC®	SPM™	VCX™
Build it Now™	HiSeC™	OPTOPLANAR™	Stealth™	Wire™
CoolFET™	I ² C™	PACMAN™	SuperFET™	
CROSSVOLT™	i-Lo™	POP™	SuperSOT™-3	
DOME™	ImpliedDisconnect™	Power247™	SuperSOT™-6	
EcoSPARK™	IntelliMAX™	PowerEdge™	SuperSOT™-8	
E ² CMOS™	ISOPLANAR™	PowerSaver™	SyncFET™	
EnSigna™	LittleFET™	PowerTrench®	TCM™	
FACT®	MICROCOUPLER™	QFET®	TinyBoost™	
FAST®	MicroFET™	QS™	TinyBuck™	
FASTr™	MicroPak™	QT Optoelectronics™	TinyPWM™	
FPS™	MICROWIRE™	Quiet Series™	TinyPower™	
FRFET™	MSX™	RapidConfigure™	TinyLogic®	
	MSXPro™	RapidConnect™	TINYOPTO™	
Across the board. Around the world.™		µSerDes™	TruTranslation™	
The Power Franchise®		ScalarPump™	UHC®	
Programmable Active Droop™				

DISCLAIMER

FAIRCHILD SEMICONDUCTOR RESERVES THE RIGHT TO MAKE CHANGES WITHOUT FURTHER NOTICE TO ANY PRODUCTS HEREIN TO IMPROVE RELIABILITY, FUNCTION OR DESIGN. FAIRCHILD DOES NOT ASSUME ANY LIABILITY ARISING OUT OF THE APPLICATION OR USE OF ANY PRODUCT OR CIRCUIT DESCRIBED HEREIN; NEITHER DOES IT CONVEY ANY LICENSE UNDER ITS PATENT RIGHTS, NOR THE RIGHTS OF OTHERS. THESE SPECIFICATIONS DO NOT EXPAND THE TERMS OF FAIRCHILD'S WORLDWIDE TERMS AND CONDITIONS, SPECIFICALLY THE WARRANTY THEREIN, WHICH COVERS THESE PRODUCTS.

LIFE SUPPORT POLICY

FAIRCHILD'S PRODUCTS ARE NOT AUTHORIZED FOR USE AS CRITICAL COMPONENTS IN LIFE SUPPORT DEVICES OR SYSTEMS WITHOUT THE EXPRESS WRITTEN APPROVAL OF FAIRCHILD SEMICONDUCTOR CORPORATION.

As used herein:

- Life support devices or systems are devices or systems which, (a) are intended for surgical implant into the body, or (b) support or sustain life, or (c) whose failure to perform when properly used in accordance with instructions for use provided in the labeling, can be reasonably expected to result in significant injury to the user.
- A critical component is any component of a life support device or system whose failure to perform can be reasonably expected to cause the failure of the life support device or system, or to affect its safety or effectiveness.

PRODUCT STATUS DEFINITIONS

Definition of Terms

Datasheet Identification	Product Status	Definition
Advance Information	Formative or In Design	This datasheet contains the design specifications for product development. Specifications may change in any manner without notice.
Preliminary	First Production	This datasheet contains preliminary data, and supplementary data will be published at a later date. Fairchild Semiconductor reserves the right to make changes at any time without notice in order to improve design.
No Identification Needed	Full Production	This datasheet contains final specifications. Fairchild Semiconductor reserves the right to make changes at any time without notice in order to improve design.
Obsolete	Not In Production	This datasheet contains specifications on a product that has been discontinued by Fairchild semiconductor. The datasheet is printed for reference information only.

Rev. I21