

# A3282

## Chopper-Stabilized Hall Effect Latch

Package LH, 3-pin Surface Mount

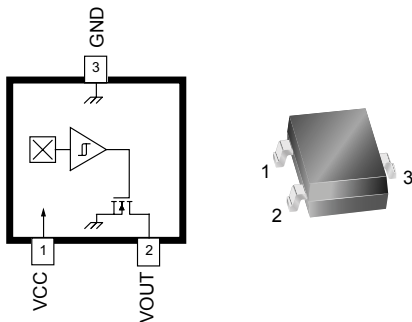

Package UA, 3-pin SIP

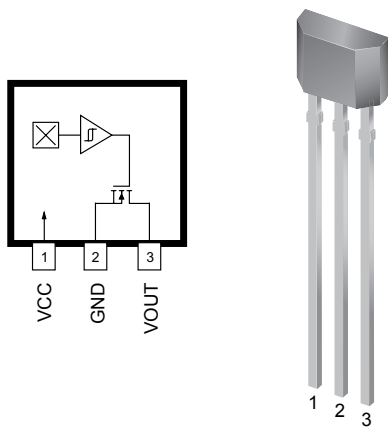

### ABSOLUTE MAXIMUM RATINGS

Supply Voltage, $V_{CC}$ .....	28 V
Reverse-Supply Voltage, $V_{RCC}$ .....	-18 V
Output Off Voltage, $V_{OUT}$ .....	26.5 V
Output Current, $I_{OUTSINK}$ .....	Internally Limited
Reverse-Output Current, $I_{ROUT}$ .....	-10 mA
Magnetic Flux Density, B .....	Unlimited
Operating Temperature	
Ambient, $T_A$ , Range E .....	-40°C to 85°C
Ambient, $T_A$ , Range L .....	-40°C to 150°C
Maximum Junction, $T_{J(MAX)}$ .....	165°C
Storage Temperature, $T_S$ .....	-65°C to 170°C

The A3282 Hall-effect sensor is a temperature stable, stress-resistant latch. Superior high-temperature performance is made possible through an Allegro® patented dynamic offset cancellation that utilizes chopper-stabilization. This method reduces the offset voltage normally caused by device overmolding, temperature dependencies, and thermal stress. The A3282 complements the current Allegro family of chopper-stabilized latching sensors.

The A3282 includes the following on a single silicon chip: voltage regulator, Hall-voltage generator, small-signal amplifier, chopper stabilization, Schmitt trigger, and a short circuit protected open-drain output. Advanced BiCMOS wafer fabrication processing is used to take advantage of low-voltage requirements, component matching, very low input-offset errors, and small component geometries.

This device requires the presence of both south and north polarity magnetic fields for operation. In the presence of a south polarity field of sufficient strength, the device output latches on, and only switches off when a north polarity field of sufficient strength is present.

The A3282 is rated for operation between the ambient temperatures -40°C and 85°C for the E temperature range, and -40°C to 150°C for the L temperature range. The two package styles available provide magnetically optimized solutions for most applications. Package LH is an SOT23W, a miniature low-profile surface-mount package, while package UA is a three-lead ultramini SIP for through-hole mounting. Each package is available in a lead (Pb) free version, with 100% matte tin plated leadframes.

### Features and Benefits

- Chopper stabilization
  - Superior temperature stability
  - Extremely low switchpoint drift
  - Insensitive to physical stress
- Output short circuit protection
- Solid state reliability
- Small size
- Robust EMC capability
- High ESD ratings (HBM)
- Reverse battery protection



# A3282

## Chopper-Stabilized Hall Effect Latch

### Product Selection Guide

Part Number	Pb-free	Packing*	Mounting	Ambient, $T_A$ (°C)	$B_{RP(MIN)}$ (G)	$B_{OP(MAX)}$ (G)
A3282ELHLT	–	7-in. reel, 3000 pieces/reel	3-pin SOT23W surface mount	–40 to 85	–150	150
A3282ELHLT-T	Yes					
A3282EUA	–	Bulk, 500 pieces/bag	3-pin SIP through hole	–40 to 150		
A3282EUA-T	Yes					
A3282LLHLT	–	7-in. reel, 3000 pieces/reel	3-pin SOT23W surface mount	–40 to 150		
A3282LLHLT-T	Yes					
A3282LUA	–	Bulk, 500 pieces/bag	3-pin SIP through hole	–40 to 150		
A3282LUA-T	Yes					

\*Contact Allegro for additional packing options.

### Functional Block Diagram

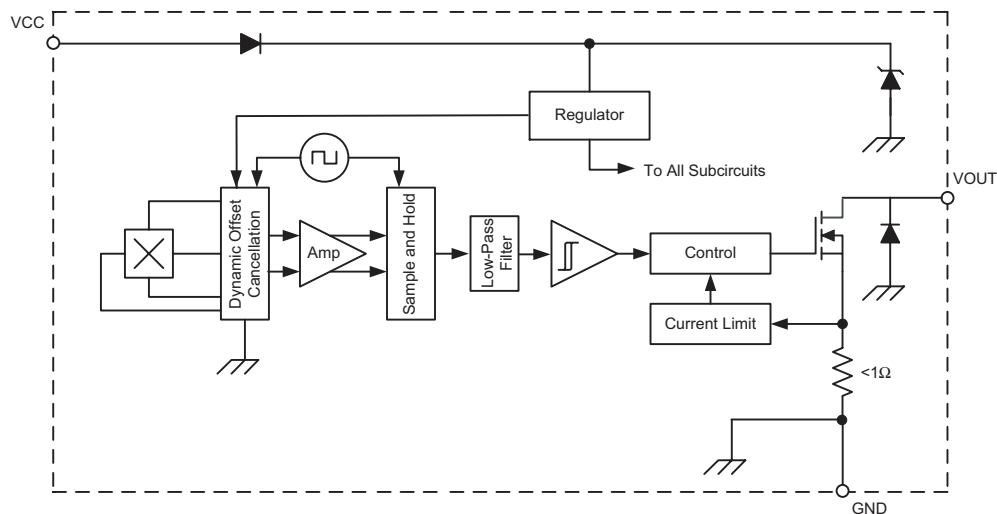

### Terminal List

Name	Description	Number	
		Package LH	Package UA
VCC	Connects power supply to chip	1	1
VOUT	Output from circuit	2	3
GND	Ground	3	2

# A3282

## Chopper-Stabilized Hall Effect Latch

**OPERATING CHARACTERISTICS** valid over full operating voltage and ambient temperature ranges, unless otherwise noted

Characteristic	Symbol	Test Conditions	Min.	Typ.	Max.	Units
<b>Electrical Characteristics</b>						
Supply Voltage <sup>1</sup>	$V_{CC}$	Operating, $T_J < 165^\circ\text{C}$	3.6	–	24	V
Output Leakage Current	$I_{OUTOFF}$	$V_{OUT} = 24\text{ V}$ , $B < B_{RP}$	–	–	10	$\mu\text{A}$
Output On Voltage	$V_{OUT(SAT)}$	$I_{OUT} = 20\text{ mA}$ , $B > B_{OP}$	–	250	500	mV
Output Current Limit	$I_{OM}$	$B > B_{OP}$	30	–	60	mA
Power-On Time	$t_{PO}$	$V_{CC} > 3.6\text{ V}$	–	8	50	$\mu\text{s}$
Chopping Frequency	$f_c$		–	200	–	kHz
Output Rise Time <sup>2</sup>	$t_r$	$R_{LOAD} = 820\ \Omega$ , $C_S = 20\text{ pF}$	–	0.2	1	$\mu\text{s}$
Output Fall Time <sup>2</sup>	$t_f$	$R_{LOAD} = 820\ \Omega$ , $C_S = 20\text{ pF}$	–	0.2	1	$\mu\text{s}$
Supply Current	$I_{CCON}$	$B > B_{OP}$	–	1.6	5	mA
	$I_{CCOFF}$	$B < B_{RP}$	–	1.6	5	mA
Reverse Battery Current	$I_{RCC}$	$V_{RCC} = -18\text{ V}$	–	–	-2	mA
Supply Zener Clamp Voltage	$V_Z$	$I_{CC} = 8\text{ mA}$ ; $T_A = 25^\circ\text{C}$	28	–	–	V
Supply Zener Current <sup>3</sup>	$I_Z$	$V_S = 28\text{ V}$	–	–	8	mA
<b>Magnetic Characteristics<sup>4</sup></b>						
Operate Point	$B_{OP}$	South pole adjacent to branded face of device	70	110	150	G
Release Point	$B_{RP}$	North pole adjacent to branded face of device	-150	-110	-70	G
Hysteresis	$B_{HYS}$	$B_{OP} - B_{RP}$	140	220	300	G

<sup>1</sup> Maximum voltage must be adjusted for power dissipation and junction temperature, see *Power Derating* section.

<sup>2</sup>  $C_S$  = oscilloscope probe capacitance.

<sup>3</sup> Maximum current limit is equal to the maximum  $I_{CC(MAX)} + 3\text{ mA}$ .

<sup>4</sup> Magnetic flux density, B, is indicated as a negative value for north-polarity magnetic fields, and as a positive value for south-polarity magnetic fields. This so-called algebraic convention supports arithmetic comparison of north and south polarity values, where the relative strength of the field is indicated by the absolute value of B, and the sign indicates the polarity of the field (for example, a -100 G field and a 100 G field have equivalent strength, but opposite polarity).

### DEVICE QUALIFICATION PROGRAM

Contact Allegro for information.

### EMC (Electromagnetic Compatibility) REQUIREMENTS

Contact Allegro for information.

# A3282

## Chopper-Stabilized Hall Effect Latch

### Electrical Characteristic Data

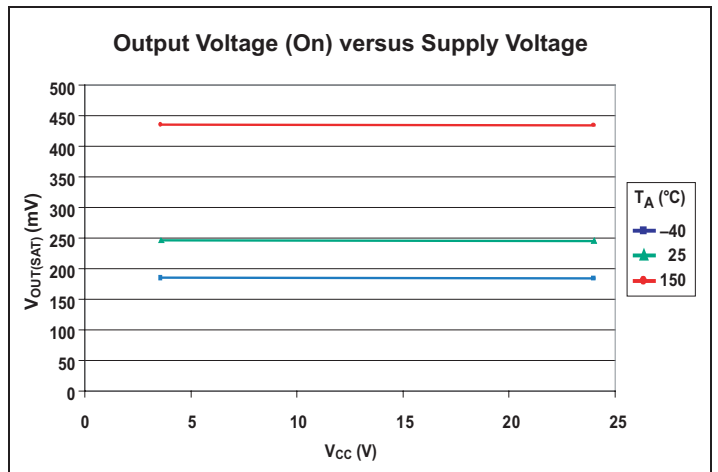
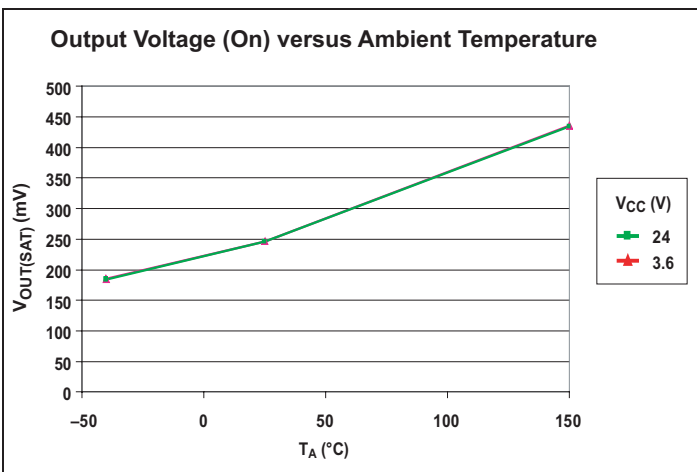
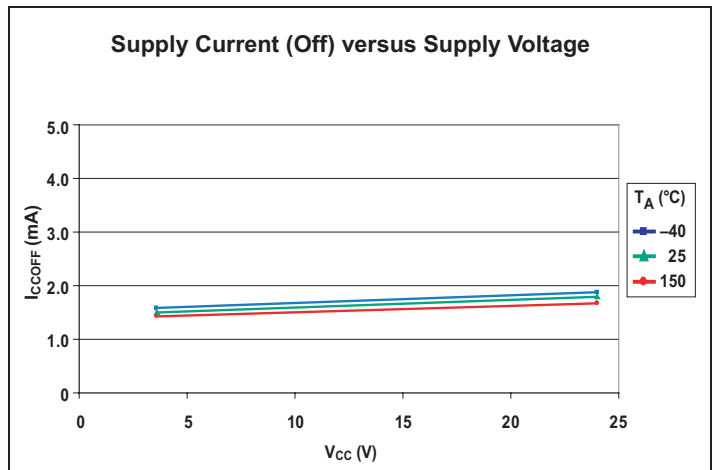
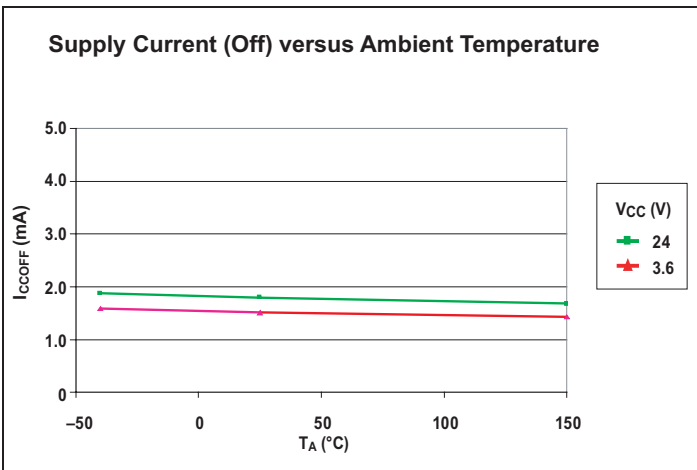
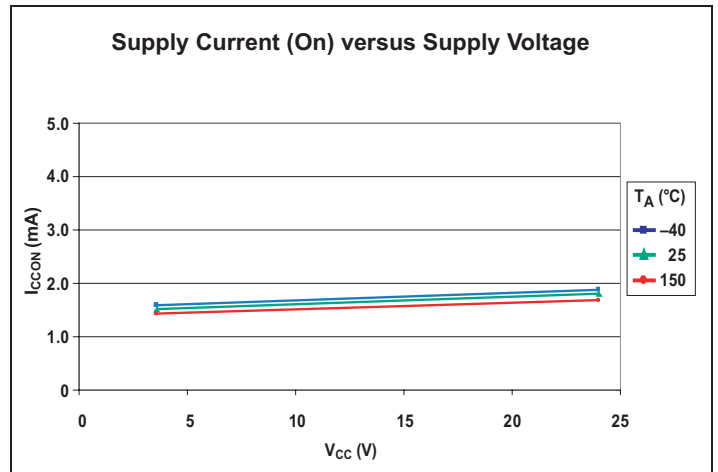
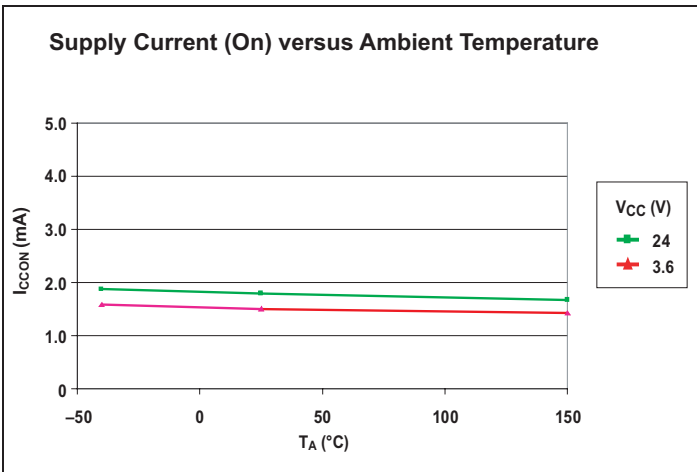

# A3282

## Chopper-Stabilized Hall Effect Latch

### Magnetic Characteristic Data

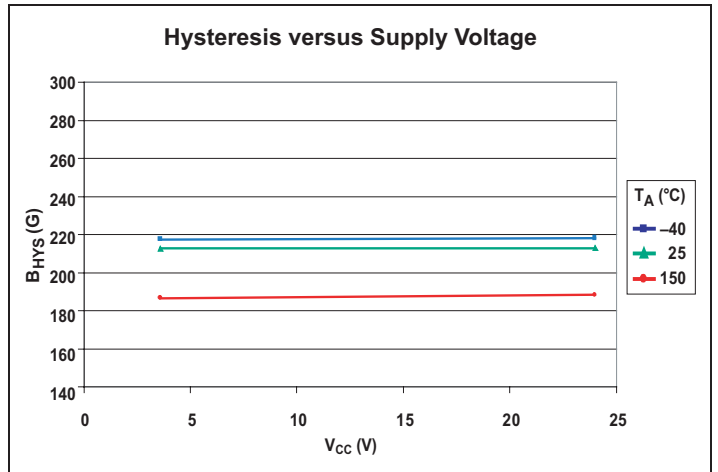
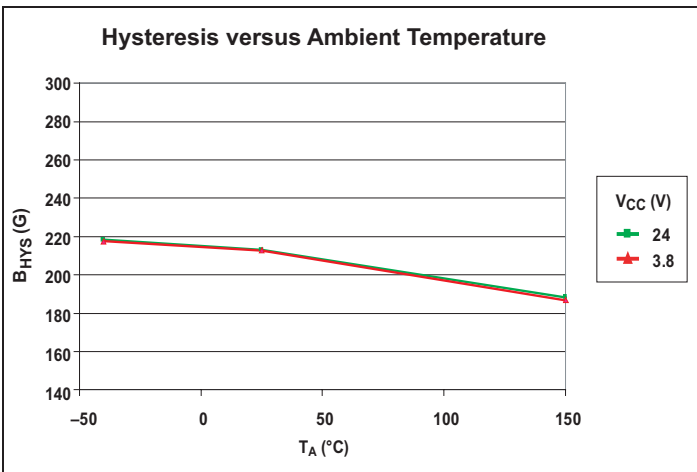
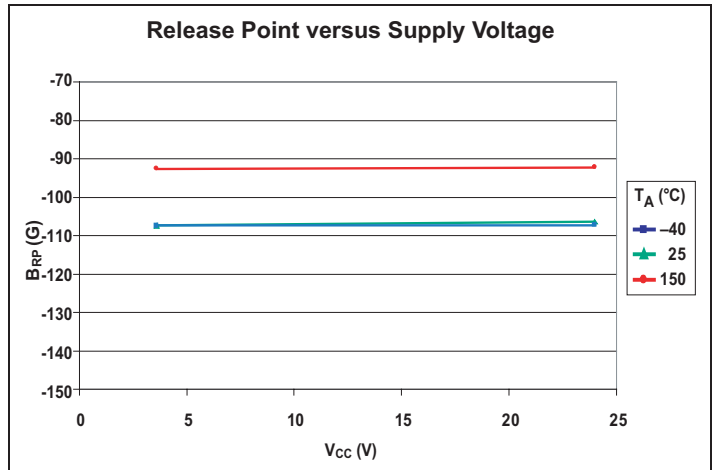
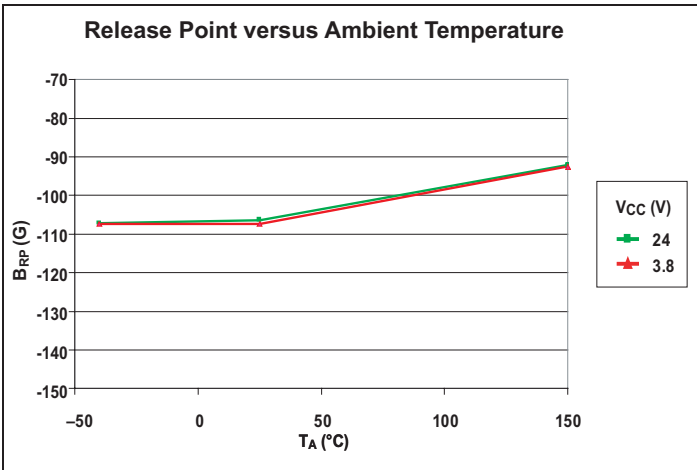
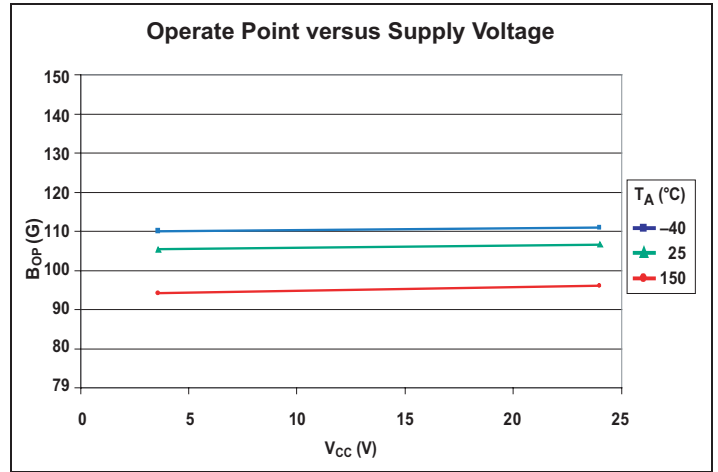
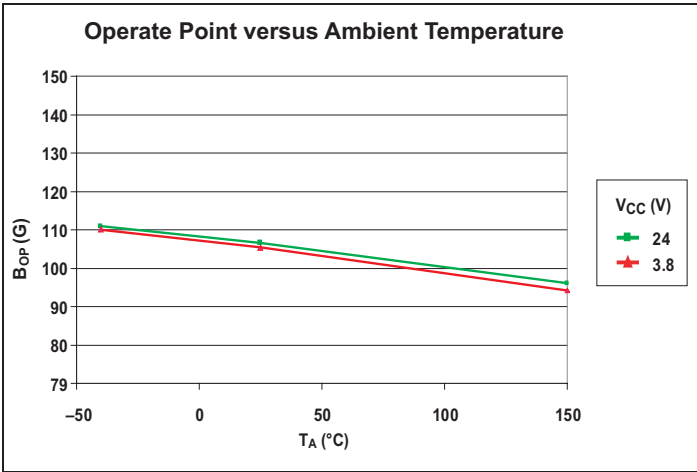

# A3282

## Chopper-Stabilized Hall Effect Latch

**THERMAL CHARACTERISTICS** may require derating at maximum conditions, see application information

Characteristic	Symbol	Test Conditions	Value	Units
Package Thermal Resistance	$R_{\theta JA}$	Package LH, minimum-K PCB (single-sided with copper limited to solder pads)	110	$^{\circ}\text{C}/\text{W}$
		Package LH, low-K PCB (double-sided with 0.926 in <sup>2</sup> copper area)	228	$^{\circ}\text{C}/\text{W}$
		Package UA, minimum-K PCB (single-sided with copper limited to solder pads)	165	$^{\circ}\text{C}/\text{W}$

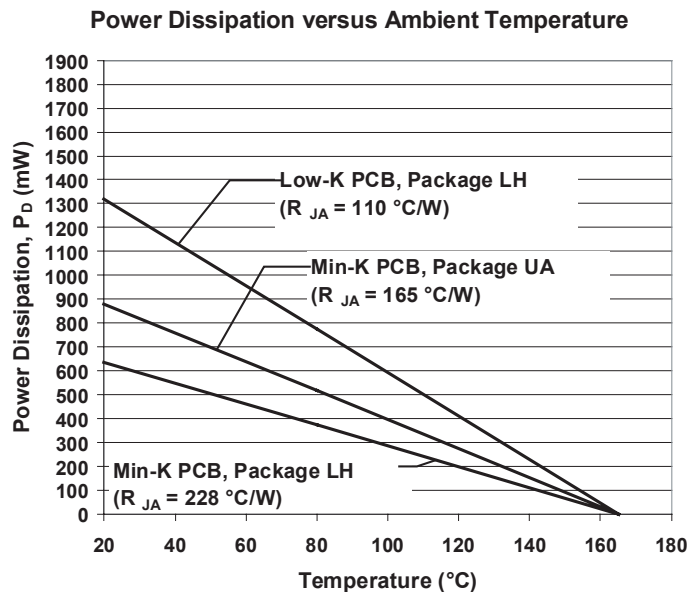
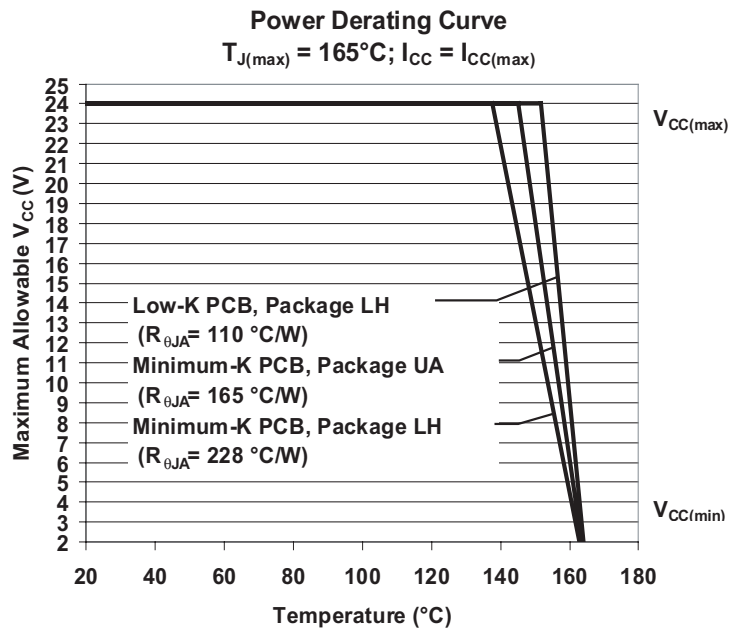

## Functional Description

**Operation**

The output of these devices switches low (turns on) when a magnetic field perpendicular to the Hall sensor exceeds the operate point threshold,  $B_{OP}$ . After turn-on, the output voltage is  $V_{OUT(SAT)}$ . The output transistor is capable of sinking current up to the short circuit current limit,  $I_{OM}$ , which is a minimum of 30 mA. Note that the device latches, that is, a south pole of sufficient strength towards the branded surface of the device turns the device on. The device remains on if the south pole is removed. When the magnetic field is reduced below the release point,  $B_{RP}$ , the device output turns off (goes high). The difference in the magnetic operate and release points is the hysteresis,  $B_{HYS}$ , of the device. This built-in hysteresis allows clean switching of the output even in the presence of external mechanical vibration and electrical noise.

Powering-on the device in the hysteresis region (less than  $B_{OP}$  and higher than  $B_{RP}$ ) allows an indeterminate output state. The correct state is attained after the first excursion beyond  $B_{OP}$  or  $B_{RP}$ .

**Applications**

It is strongly recommended that an external bypass capacitor be connected (in close proximity to the Hall sensor) between the supply and ground of the device to reduce both external noise and noise generated by the chopper stabilization technique. As is shown in Panel B of figure 1, a 0.1  $\mu$ F capacitor is typical.

Extensive applications information on magnets and Hall-effect sensors is available in:

- *Hall-Effect IC Applications Guide*, AN27701,
- *Hall-Effect Devices: Gluing, Potting, Encapsulating, Lead Welding and Lead Forming*, AN27703.1
- *Soldering Methods for Allegro's Products – SMT and Through-Hole*, AN26009

All are provided in *Allegro Electronic Data Book*, AMS-702 and the Allegro Web site: [www.allegromicro.com](http://www.allegromicro.com)

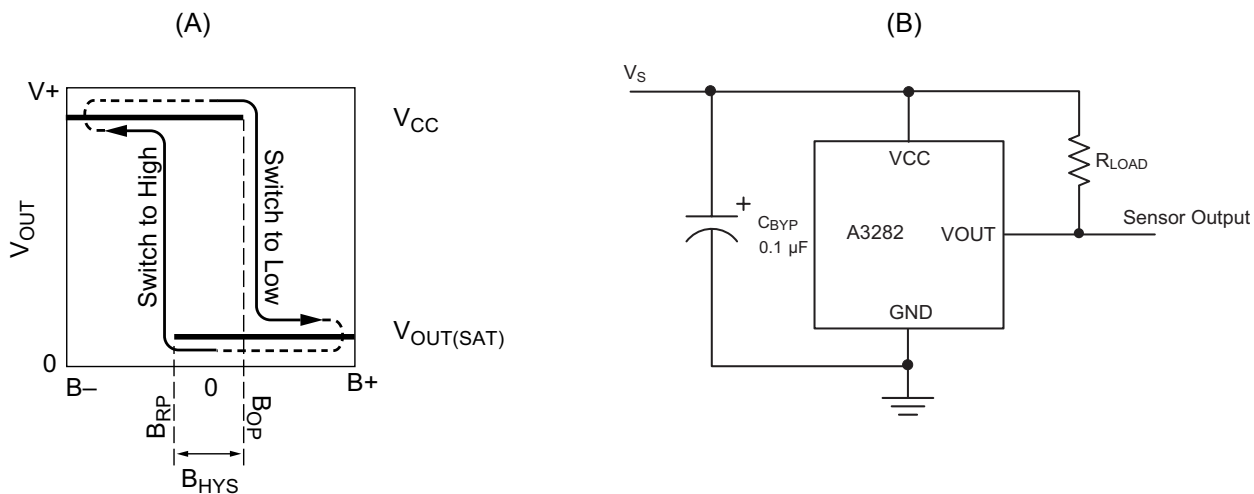

Figure 1: Switching Behavior of Latches. In Panel A, on the horizontal axis, the B+ direction indicates increasing south polarity magnetic field strength, and the B- direction indicates decreasing south polarity field strength (including the case of increasing north polarity). This behavior can be exhibited when using a circuit such as that shown in panel B.

### Chopper Stabilization Technique

When using Hall-effect technology, a limiting factor for switchpoint accuracy is the small signal voltage developed across the Hall element. This voltage is disproportionately small relative to the offset that can be produced at the output of the Hall sensor. This makes it difficult to process the signal while maintaining an accurate, reliable output over the specified operating temperature and voltage ranges.

Chopper stabilization is a unique approach used to minimize Hall offset on the chip. The patented Allegro technique, namely Dynamic Quadrature Offset Cancellation, removes key sources of the output drift induced by thermal and mechanical stresses. This offset reduction technique is based on a signal modulation-demodulation process. The undesired offset signal is separated from the magnetic-field-induced signal in the frequency domain, through modulation. The subsequent demodulation acts as a modulation process for the offset, causing the magnetic-field-induced signal to recover its original spectrum at baseband, while the dc offset becomes a high-frequency signal. The magnetic-field-induced signal then can pass through a low-pass filter, while the modulated dc offset is suppressed. This configuration is illustrated in figure 2.

The chopper stabilization technique uses a 200 kHz high-frequency clock. For demodulation process, a sample and hold technique is used, where the sampling is performed at twice the chopper frequency (400 kHz). This high-frequency operation allows a greater sampling rate, which results in higher accuracy and faster signal-processing capability. This approach desensitizes the chip to the effects of thermal and mechanical stresses, and produces devices that have extremely stable quiescent Hall output voltages and precise recoverability after temperature cycling. This technique is made possible through the use of a BiCMOS process, which allows the use of low-offset, low-noise amplifiers in combination with high-density logic integration and sample-and-hold circuits.

The repeatability of magnetic-field-induced switching is affected slightly by a chopper technique. However, the Allegro high-frequency chopping approach minimizes the affect of jitter and makes it imperceptible in most applications. Applications that are more likely to be sensitive to such degradation are those requiring precise sensing of alternating magnetic fields; for example, speed sensing of ring-magnet targets. For such applications, Allegro recommends its digital sensor families with lower sensitivity to jitter. For more information on those devices, contact your Allegro sales representative.

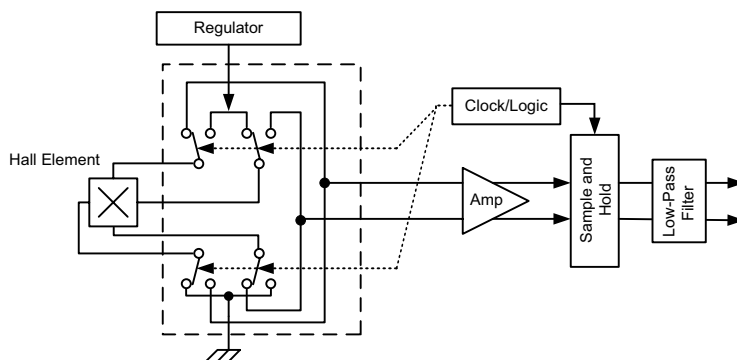

Figure 2. Chopper Stabilization Circuit (Dynamic Quadrature Offset Cancellation)



### Power Derating

The device must be operated below the maximum junction temperature of the device,  $T_{J(max)}$ . Under certain combinations of peak conditions, reliable operation may require derating supplied power or improving the heat dissipation properties of the application. This section presents a procedure for correlating factors affecting operating  $T_J$ . (Thermal data is also available on the Allegro MicroSystems Web site.)

The Package Thermal Resistance,  $R_{\theta JA}$ , is a figure of merit summarizing the ability of the application and the device to dissipate heat from the junction (die), through all paths to the ambient air. Its primary component is the Effective Thermal Conductivity,  $K$ , of the printed circuit board, including adjacent devices and traces. Radiation from the die through the device case,  $R_{\theta JC}$ , is relatively small component of  $R_{\theta JA}$ . Ambient air temperature,  $T_A$ , and air motion are significant external factors, damped by overmolding.

The effect of varying power levels (Power Dissipation,  $P_D$ ), can be estimated. The following formulas represent the fundamental relationships used to estimate  $T_J$ , at  $P_D$ .

$$P_D = V_{IN} \times I_{IN} \quad (1)$$

$$\Delta T = P_D \times R_{\theta JA} \quad (2)$$

$$T_J = T_A + \Delta T \quad (3)$$

For example, given common conditions such as:  $T_A = 25^\circ\text{C}$ ,  $V_{CC} = 12\text{ V}$ ,  $I_{CC} = 1.5\text{ mA}$ , and  $R_{\theta JA} = 165\text{ }^\circ\text{C/W}$ , then:

$$P_D = V_{CC} \times I_{CC} = 12\text{ V} \times 1.5\text{ mA} = 18\text{ mW}$$

$$\Delta T = P_D \times R_{\theta JA} = 18\text{ mW} \times 165\text{ }^\circ\text{C/W} = 3^\circ\text{C}$$

$$T_J = T_A + \Delta T = 25^\circ\text{C} + 3^\circ\text{C} = 28^\circ\text{C}$$

A worst-case estimate,  $P_{D(max)}$ , represents the maximum allowable power level ( $V_{CC(max)}$ ,  $I_{CC(max)}$ ), without exceeding  $T_{J(max)}$ , at a selected  $R_{\theta JA}$  and  $T_A$ .

*Example:* Reliability for  $V_{CC}$  at  $T_A = 150^\circ\text{C}$ , package LH, using a low-K PCB.

Observe the worst-case ratings for the device, specifically:  $R_{\theta JA} = 228\text{ }^\circ\text{C/W}$ ,  $T_{J(max)} = 165^\circ\text{C}$ ,  $V_{CC(max)} = 24\text{ V}$ , and  $I_{CC(max)} = 5\text{ mA}$ .

Calculate the maximum allowable power level,  $P_{D(max)}$ . First, invert equation 3:

$$\Delta T_{max} = T_{J(max)} - T_A = 165^\circ\text{C} - 150^\circ\text{C} = 15^\circ\text{C}$$

This provides the allowable increase to  $T_J$  resulting from internal power dissipation. Then, invert equation 2:

$$P_{D(max)} = \Delta T_{max} \div R_{\theta JA} = 15^\circ\text{C} \div 228\text{ }^\circ\text{C/W} = 66\text{ mW}$$

Finally, invert equation 1 with respect to voltage:

$$V_{CC(est)} = P_{D(max)} \div I_{CC(max)} = 66\text{ mW} \div 5\text{ mA} = 13\text{ V}$$

The result indicates that, at  $T_A$ , the application and device can dissipate adequate amounts of heat at voltages  $\leq V_{CC(est)}$ .

Compare  $V_{CC(est)}$  to  $V_{CC(max)}$ . If  $V_{CC(est)} \leq V_{CC(max)}$ , then reliable operation between  $V_{CC(est)}$  and  $V_{CC(max)}$  requires enhanced  $R_{\theta JA}$ . If  $V_{CC(est)} \geq V_{CC(max)}$ , then operation between  $V_{CC(est)}$  and  $V_{CC(max)}$  is reliable under these conditions.

# A3282

## Chopper-Stabilized Hall Effect Latch

### Package LH, 3-Pin (SOT-23W)

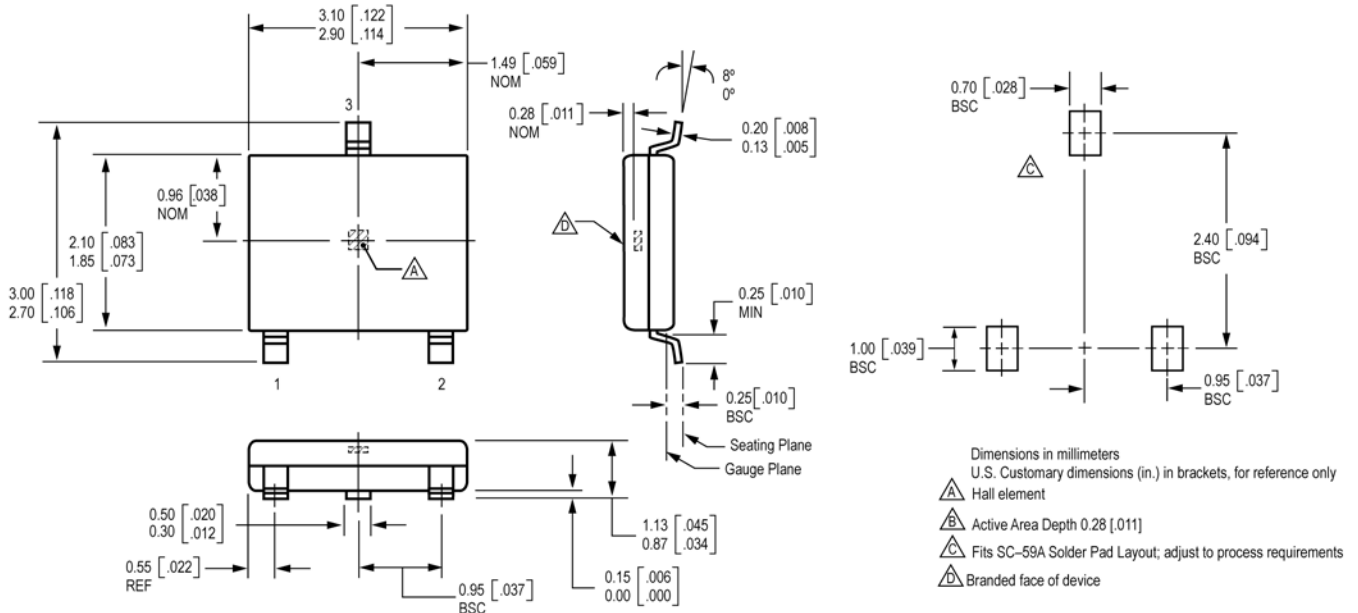

### Package UA, 3-Pin

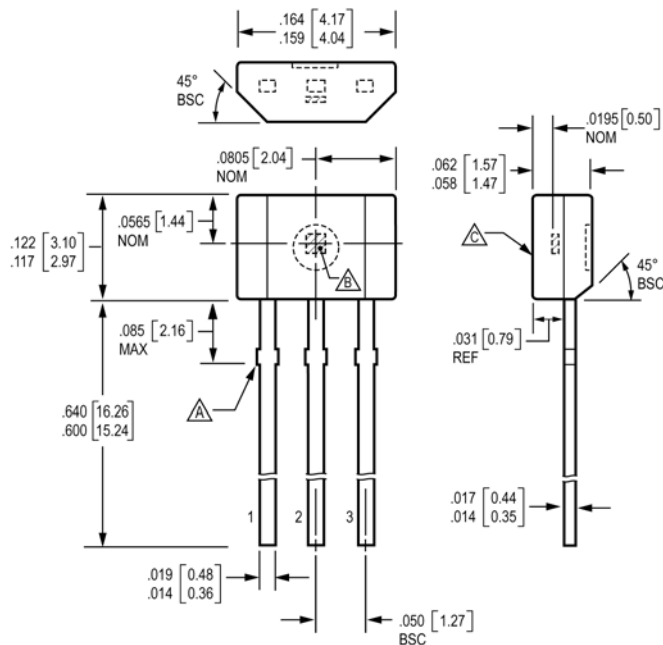

# A3282

## Chopper-Stabilized Hall Effect Latch

*The products described herein are manufactured under one or more of the following U.S. patents: 5,045,920; 5,264,783; 5,442,283; 5,389,889; 5,581,179; 5,517,112; 5,619,137; 5,621,319; 5,650,719; 5,686,894; 5,694,038; 5,729,130; 5,917,320; and other patents pending.*

*Allegro MicroSystems, Inc. reserves the right to make, from time to time, such departures from the detail specifications as may be required to permit improvements in the performance, reliability, or manufacturability of its products. Before placing an order, the user is cautioned to verify that the information being relied upon is current.*

*Allegro products are not authorized for use as critical components in life-support devices or systems without express written approval.*

*The information included herein is believed to be accurate and reliable. However, Allegro MicroSystems, Inc. assumes no responsibility for its use; nor for any infringement of patents or other rights of third parties which may result from its use.*

*Copyright © 2005 Allegro MicroSystems, Inc.*