

ELECTRICAL SPECIFICATIONS:

- |     |  |  |
|-----|--|--|
| 1.0 | URNS RATIO: (P12-P18-P13) : (J3-J6)                | : 1CT : 1CT ±3%                          |
|     | (P10-P9-P11) : (J1-J2)                             | : 1CT : 1CT ±3%                          |
| 2.0 | INDUCTANCE: (P12-P13)                              | : 400uH MIN. @ 0.1V, 100KHz, 8mA DC Bias |
|     | (J1-J2)  | : 400uH MIN. @ 0.1V, 100KHz, 8mA DC Bias |
| 3.0 | LEAKAGE INDUCTANCE: P12-P13 (WITH J6 AND J3 SHORT) | : 0.3uH MAX. @ 1MHz                      |
|     | P10-P11 (WITH J2 AND J1 SHORT)                     | : 0.3uH MAX. @ 1MHz                      |
| 4.0 | INTERWINDING CAPACITANCE: (P12,P13) TO (J6,J3)     | : 30pf MAX @ 1MHz                        |
|     | (P10,P9,P11) TO (J2,J1)                            | : 30pf MAX @ 1MHz                        |
| 5.0 | DC RESISTANCE: (J6-J3)=(J2-J1)                     | : 1.2 ohms Max.                          |

 <b>Stewart Connector</b>	<b>InNet Technologies, Inc.</b> <a href="http://www.innet-tech.com">http://www.innet-tech.com</a>
	<b>Stewart Connector Systems</b> <a href="http://www.stewartconnector.com">http://www.stewartconnector.com</a>
SHEET 1 OF 4	DRAWING NO. SI-70033
	REV. 07

6.0 RETURN LOSS: (P10-P11)=100 OHMS AND (J3-J6)=100 OHM REF.  
1MHz TO 30MHz : -20dB MIN.  
30MHz TO 60MHz :  $-(19-20\text{LOG}(f/30\text{MHz}))$  MIN  
80MHz : -12dB MIN.

NOTE: 100 OHMS CONNECTED TO (J2-J1) OR (P12-P13).

7.0 DIELECTRIC WITHSTAND: (J1, J2) TO (P10, P11) : 1500 RMS  
(J3, J6) TO (P12, P13) : 1500 RMS

8.0 INSERTION LOSS: RS=RL=100 ohms  
1MHz TO 65MHz : -1 dB MAX

9.0 RISE TIME: RS=100 OHMS AND RL = 100 OHMS  
OUTPUT VOLTAGE = 1 V peak : 3.0 nS MAX  
PULSE WIDTH= 112nS : 3.0 nS MAX

10.0 CROSS TALK: 1-65 MHz : -35 dB MIN.

11.0 COMMON TO COMMON MODE ATTENUATION: 30MHz TO 100MHz : -30 dB MIN  
100MHz TO 130MHz : -20 dB MIN



InNet Technologies, Inc.  
<http://www.innet-tech.com>



Stewart Connector Systems  
<http://www.stewartconnector.com>

SHEET  
2 OF 4

DRAWING NO.

SI-70033

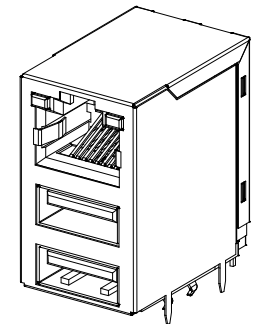
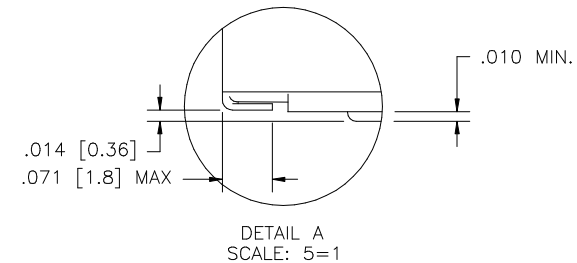
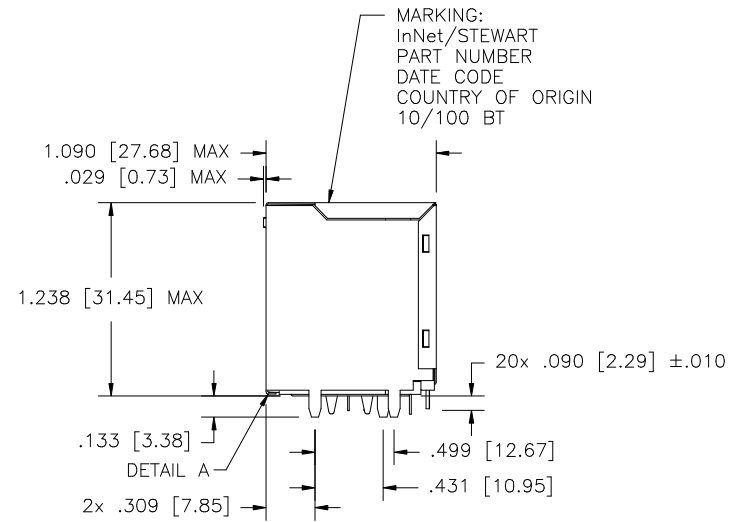
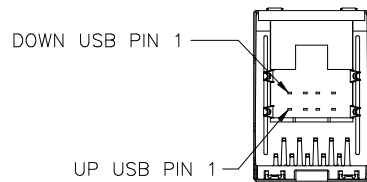
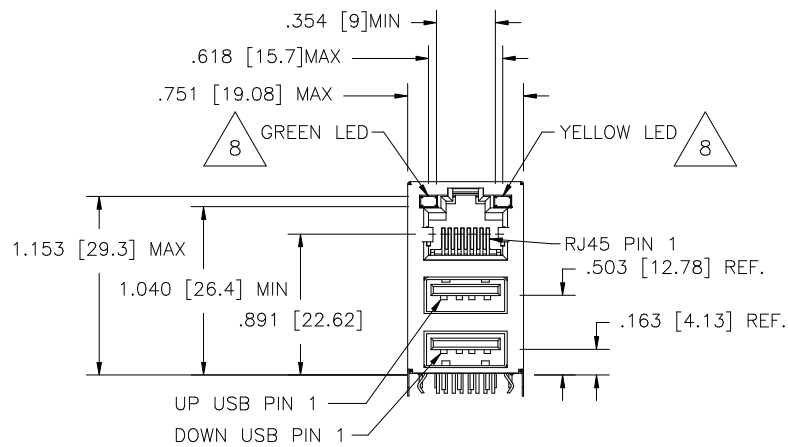

REV. 07



NOTES:



- 1.0 TOLERANCE COMPLY WITH FCC DIMENSION REQUIREMENTS.
- 2.0 MATERIAL:  
 PLASTIC: UL94V-Ø  
 TERMINAL USB: CERTIFIED TO USB SPEC 2.0  
 TERMINAL RJ45: 50 MICROINCHES Au OVER 50 MICROINCHES Ni OVER PHOSBRONZE SHIELD, BOTH USB AND RJ45: BRASS PLATED W/EITHER Ni OR TIN-LEAD
- 3.0 GENERAL TOLERANCE: ±.005 [.127]
- 4.0 INSERTION FORCE RJ45: 9.0 lbs MAX  
 INSERTION FORCE USB: 7.7 lbs MAX
- 5.0 WITHDRAW FORCE RJ45: 2.9 lbs MIN  
 WITHDRAW FORCE USB: 2.2 lbs MIN
- 6.0 DURABILITY FORCE RJ45: 1000 INSERTIONS  
 DURABILITY FORCE USB: 1500 INSERTIONS
- 7.0 CONNECTOR TO PCB INSERTION FORCE: 8.6 lbs MAX

 LED LENS LOCATED IN THE FRONT SURFACE

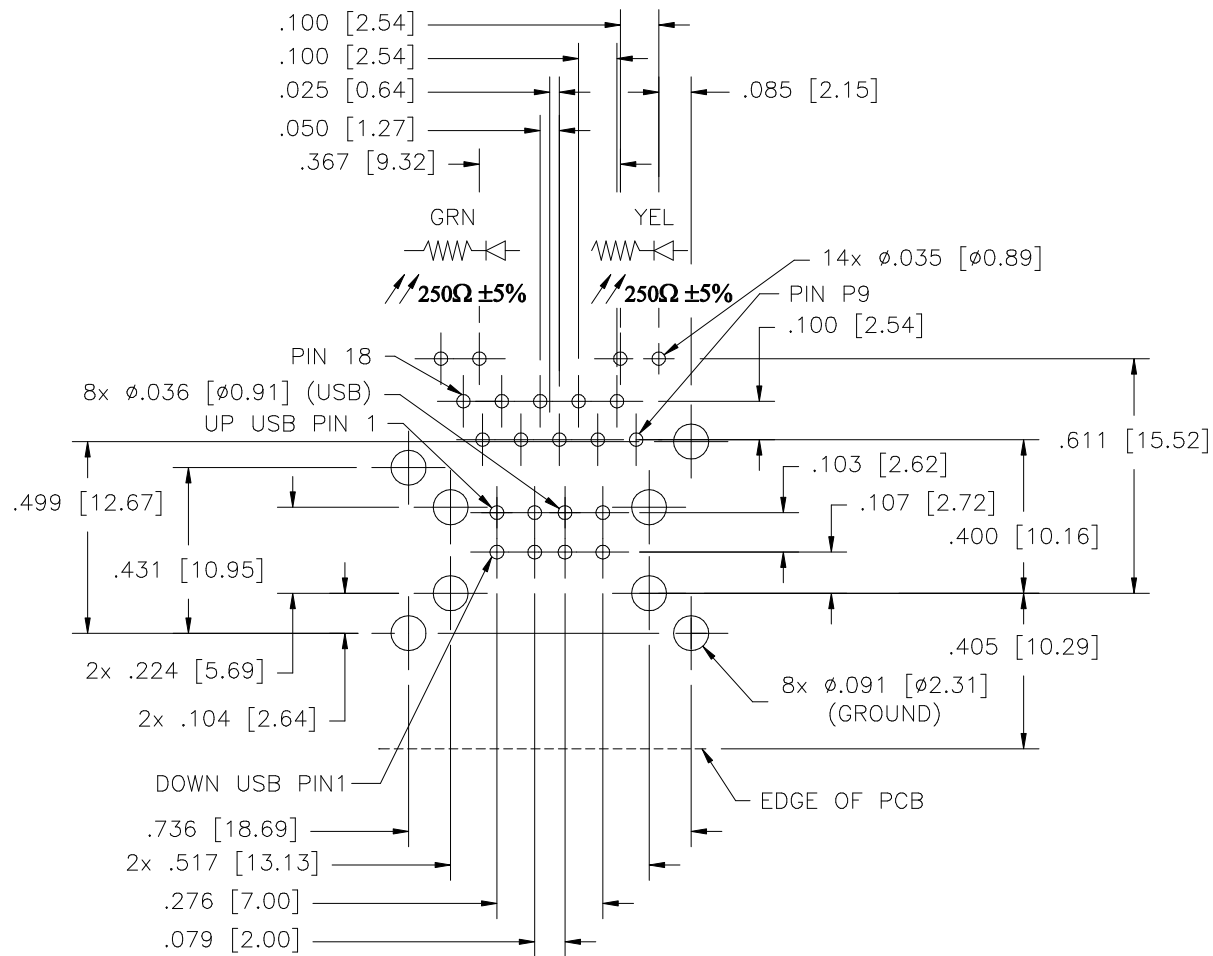
 InNet Technologies, Inc. <a href="http://www.innet-tech.com">http://www.innet-tech.com</a>	
 Stewart Connector Systems <a href="http://www.stewartconnector.com">http://www.stewartconnector.com</a>	
SHEET 3 OF 4	DRAWING NO. SI-70033 REV. 02



PC BOARD LAYOUT COMPONENT SIDE SHOWN  
 TOLERANCE: ±.003 [.08] UNLESS OTHERWISE SPECIFIED

		InNet Technologies, Inc. <a href="http://www.innet-tech.com">http://www.innet-tech.com</a>	
		Stewart Connector Systems <a href="http://www.stewartconnector.com">http://www.stewartconnector.com</a>	
SHEET 4 OF 4		DRAWING NO. SI-70033 REV. 02	