

NON-ISOLATED DC/DC CONVERTERS

3.3V Input / 0.9V – 2.5V Output / 10A



BP03V7PB-10C

V7PB-10C Series

- Nonisolated
- Industry standard footprint
- Fixed frequency
- High efficiency means less power dissipation
- Excellent thermal performance
- Optimized for cost
- Remote on/off
- Remote sense
- Undervoltage lockout (UVLO)
- Over current and short circuit protection
- Industrial temperature range



Description

The Bel V7PB-10C modules are a series of non-isolated, step down DC/DC power converters that operate from a nominal 3.3V source. These converters are available in a range of output voltages from 0.9V to 2.5V. They are packaged in a compact, SIP package rated at 10A. Standard features include remote on/off, over current and short circuit protection, output voltage adjust and industrial temperature range (-40° to +85° C). The output is closely regulated and the efficiency is typically 95% @ 2.5V output at full load. These products may be used almost anywhere low voltage silicon is employed and a 3.3V source is available. Typical applications include file servers, routers, line cards and other computing and communications equipment.

Applications

- Distributed power architectures
- Data networking equipment
- Telecommunications
- Computers and peripherals

Part Number Selection

Output Voltage	Input Voltage	Max. Output Current	Max. Output Power	Typical Efficiency	Part Number Remote Sense Active Low	Part Number Remote Sense Active High
2.5V	3.3V	10A	25W	95%	V7PB-10C25L	V7PB-10C25S
1.8V	3.3V	10A	18W	92.5%	V7PB-10C18L	V7PB-10C18S
1.5V	3.3V	10A	15W	91.5%	V7PB-10C15L	V7PB-10C15S
1.2V	3.3V	10A	12W	90%	V7PB-10C12L	V7PB-10C12S
0.9V	3.3V	10A	9W	87%	V7PB-10C09L	V7PB-10C09S

BP03V7PB-10C

Absolute Maximum Ratings

Parameter	Symbol	Min	Typical	Max	Unit
Continuous Input Voltage	V _{in}	-0.3		4	V
Output Enable Terminal Voltage	V _{outen}	-0.3		6	V
Ambient Temperature	T _{amb}	-40		85	°C
Storage Temperature	T _{stor}	-55		105	°C

Note: Use beyond the maximum ratings may cause a reliability degradation of the DC/DC converter or may permanently damage the device.

Input Specifications

Parameter	Module	Symbol	Min	Typical	Max	Units
Operating Input Voltage	All	V _{in}	3	3.3	3.6	V
Input Current	2.5V 1.8V 1.5V 1.2V 0.9V	I _{in}			10 7.3 6.2 5.0 3.9	A
No Load Input Current	2.5V 1.8V 1.5V 1.2V 0.9V			120 165 150 180 165	220 220 220 220 220	mA
Remote Off Input Current	2.5V 1.8V 1.5V 1.2V 0.9V			6 6 3 3 3	10 10 10 10 10	mA
Input Reflected Ripple Current ¹	2.5V 1.8V 1.5V 1.2V 0.9V			25 30 30 28 23	60 60 60 60 60	mArms
Input Reflected Ripple Current ¹	2.5V 1.8V 1.5V 1.2V 0.9V			80 95 95 92 75	150 150 150 150 150	mApk
I _{in} Inrush Current Transient	2.5V 1.8V 1.5V 1.2V 0.9V			0.020 0.010 0.010 0.006 0.006		A ² s
Turn On Voltage Threshold	All			2.8		V
Turn Off Voltage Threshold	All			2.5		V

Note:
 Input capacitance two 270µF/
 16V, ESR = 0.018 Ω max at
 100kHz @ 25° C.
 1. With simulated source
 impedance of 500nH, 5Hz to
 20MHz.

NON-ISOLATED DC/DC CONVERTERS

3.3V Input / 0.9V – 2.5V Output / 10A



BP03V7PB-10C

Output Specifications

Parameter	Module	Symbol	Min	Typical	Max	Units
Output Voltage Set Point ¹	2.5V	Vout	2.450	2.5	2.550	V
	1.8V		1.764	1.8	1.836	
	1.5V		1.470	1.5	1.530	
	1.2V		1.176	1.2	1.224	
	0.9V		0.882	0.9	0.918	
Load Regulation	2.5V			6	12.5	mV
	1.8V			5	9.0	
	1.5V			4	7.5	
	1.2V			4	7.5	
	0.9V			4	7.5	
Line Regulation	2.5V			4	7.5	mV
	1.8V			3	5.5	
	1.5V			3	4.5	
	1.2V			3	4.5	
	0.9V			3	4.5	
Regulation Over Temperature	2.5V			30	50	mV
	1.8V			20	40	
	1.5V			15	30	
	1.2V			15	25	
	0.9V			10	20	
Total Output Voltage Regulation	2.5V			40	70	mV
	1.8V			28	54.5	
	1.5V			22	42	
	1.2V			22	37	
	0.9V			17	32	
Output Ripple and Noise ²	2.5V			20	40	mVpk
	1.8V			25	40	
	1.5V			25	40	
	1.2V			22	40	
	0.9V			20	40	
Output Ripple and Noise ²	2.5V			5	10	mVrms
	1.8V			6	10	
	1.5V			6	10	
	1.2V			6	10	
	0.9V			5	10	
Output Current Range	All	Iout	0		10	A
Output DC Current Limit	All	Ioutlim	13		25	A
Short Circuit Surge	2.5V	Ioutsurge		0.23		A ² s
	1.8V			0.22		
	1.5V			0.22		
	1.2V			0.20		
	0.9V			0.27		
Turn on Time	All	Ton		6	10	ms
Overshoot at Turn On	All			0	3	%
Output Capacitance	All	Cout	0		5600	μF

Note: All specifications are typical at nominal input, full load at 25° C unless otherwise stated.

1. Vin = 3.3V, Iout = full load, Ta = 25° C.
2. 0 - 20MHz, 1μF ceramic cap on output.

BP03V7PB-10C

Output Specifications

Parameter	Module	Symbol	Min	Typical	Max	Units
Transient Response ³						
ΔV 50% to 100% of Max Load	2.5V			90	130	mV
Settling Time		Ts		30	50	μs
ΔV 100% to 50% of Max Load				100	130	mV
Settling Time		Ts		30	50	μs
Transient Response ³						
ΔV 50% to 100% of Max Load	1.8V			85	120	mV
Settling Time		Ts		30	50	μs
ΔV 100% to 50% of Max Load				90	120	mV
Settling Time		Ts		30	50	μs
Transient Response ³						
ΔV 50% to 100% of Max Load	1.5V			80	120	mV
Settling Time		Ts		30	50	μs
ΔV 100% to 50% of Max Load				85	120	mV
Settling Time		Ts		30	50	μs
Transient Response ³						
ΔV 50% to 100% of Max Load	1.2V			80	110	mV
Settling Time		Ts		30	50	μs
ΔV 100% to 50% of Max Load				85	110	mV
Settling Time		Ts		30	50	μs
Transient Response ³						
ΔV 50% to 100% of Max Load	0.9V			75	100	mV
Settling Time		Ts		30	50	μs
ΔV 100% to 50% of Max Load				75	100	mV
Settling Time		Ts		30	50	μs

Note: All specifications are typical at nominal input, full load at 25° C unless otherwise stated.
 3. di/dt = 0.5A/1 μ S, Ta = 25° C without external load capacitance.

©2003 Bel Fuse Inc. Specifications subject to change without notice. 09.03

NON-ISOLATED DC/DC CONVERTERS

3.3V Input / 0.9V – 2.5V Output / 10A



BP03V7PB-10C

General Specifications

Parameter	Module	Symbol	Min	Typical	Max	Units
Efficiency ¹	2.5V	η	92	95		%
	1.8V		90.5	92.5		
	1.5V		89	91.5		
	1.2V		88	90		
	0.9V		85	87		
Switching Frequency	All	Fsw	250	300	340	kHz
Output Voltage Trim Range ²	All		90		110	%
Remote Sense Compensation					10	%
Weight	All			9.2		g

1. Vin=3.3V, full load and Ta=25° C.

2. See graphs on pages 11-15.

Control Specifications

Parameter	Module	Symbol	Min	Typical	Max	Units
Remote On/Off ³	All	Vouten				V
Signal Low (Unit Off)	V7PB-10CxxS		-0.3		0.8	V
Signal High (Unit On)			2.5		5.5	V
Signal Low (Unit On)	V7PB-10CxxL		-0.3		0.8	V
Signal High (Unit Off)			2.5		5.5	V

3. With remote on/off pin 11 open, the module is on.

Note: On/off pin designed to work with an open collector/drain switch.

BP03V7PB-10C

Efficiency Data

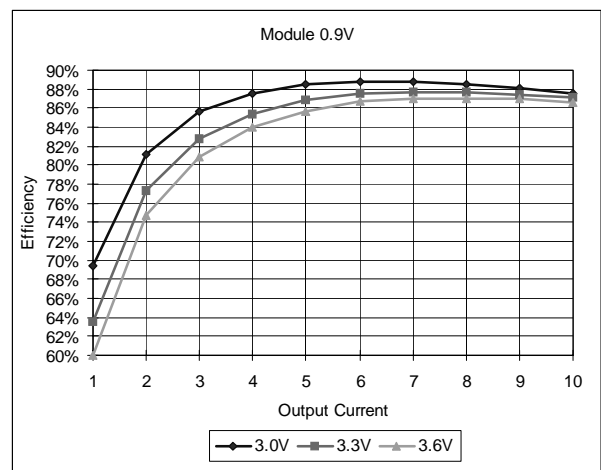
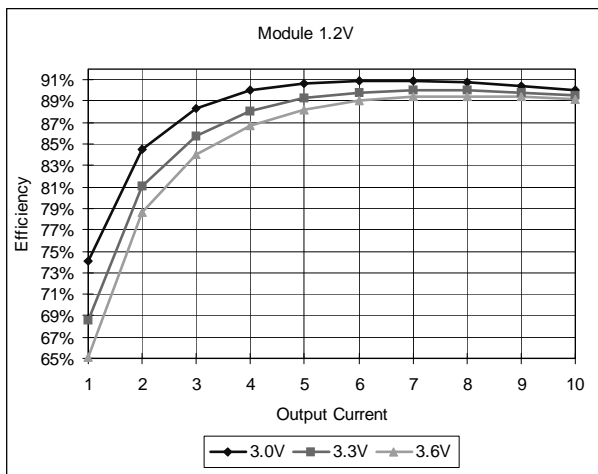
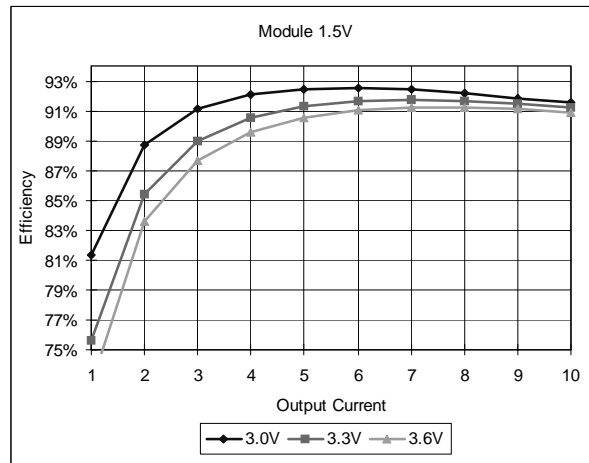
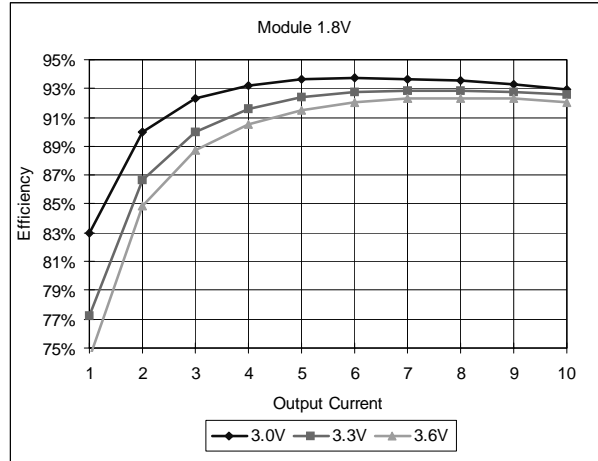
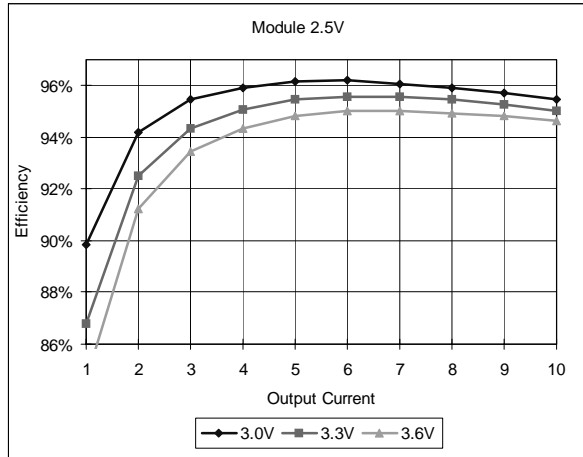

NON-ISOLATED DC/DC CONVERTERS

3.3V Input / 0.9V – 2.5V Output / 10A



BP03V7PB-10C

Ripple and Noise

1 μ F ceramic cap added at the output.

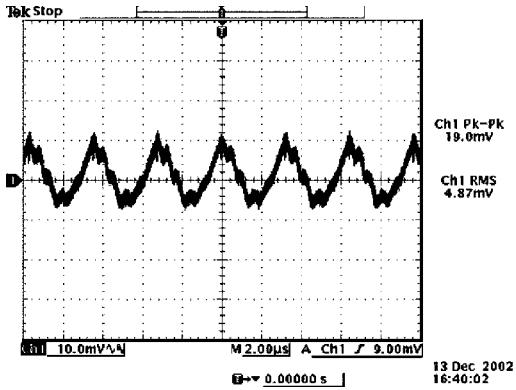

Ripple and noise at full load and 3.3Vdc input, 2.5Vdc output and Ta=25° C

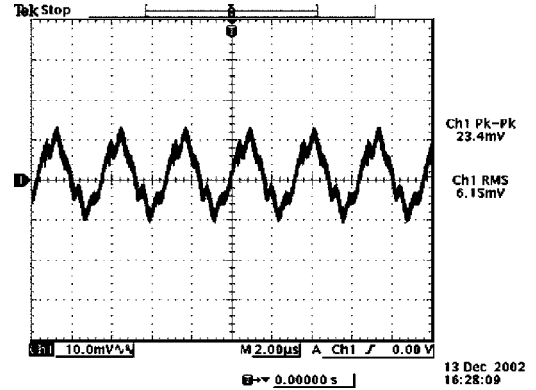

Ripple and noise at full load and 3.3Vdc input, 1.8Vdc output and Ta=25° C

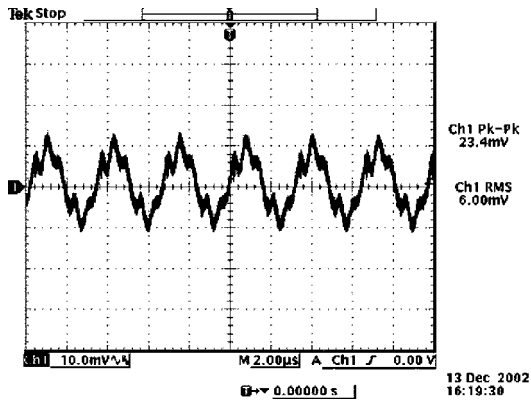

Ripple and noise at full load and 3.3Vdc input, 1.5Vdc output and Ta=25° C

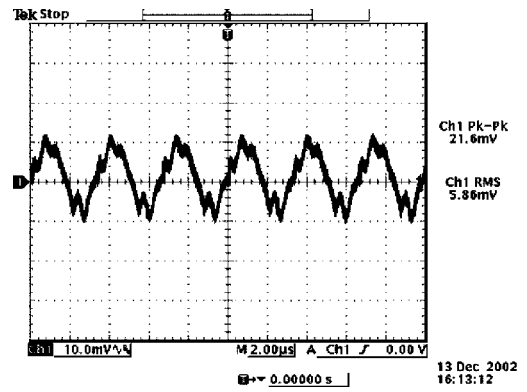

Ripple and noise at full load and 3.3Vdc input, 1.2Vdc output and Ta=25° C

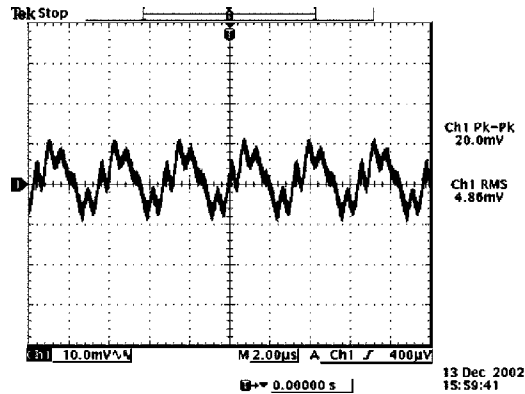

Ripple and noise at full load and 3.3Vdc input, 0.9Vdc output and Ta=25° C

BP03V7PB-10C

Transient Response

Transient response: $di/dt = 0.5A/\mu S$, no external load capacitance

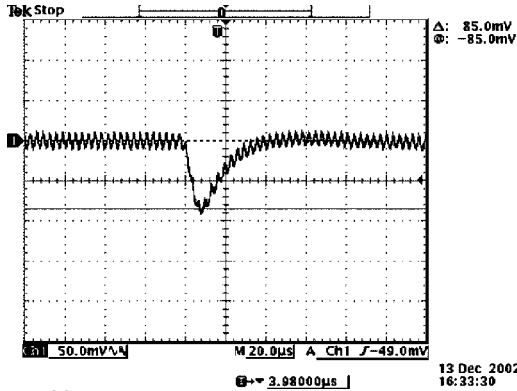

Vout=2.5V
50% to 100% load transients at 3.3V input and Ta=25° C

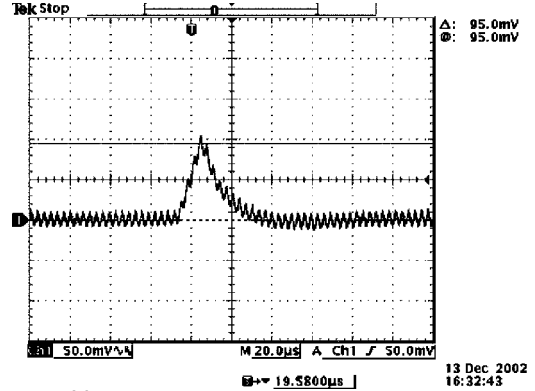

Vout=2.5V
100% to 50% load transients at 3.3V input and Ta=25° C

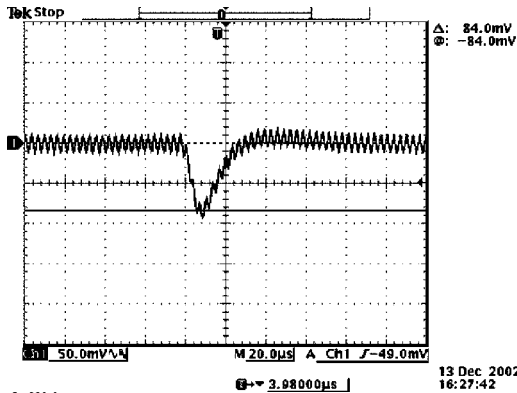

Vout=1.8V
50% to 100% load transients at 3.3V input and Ta=25° C

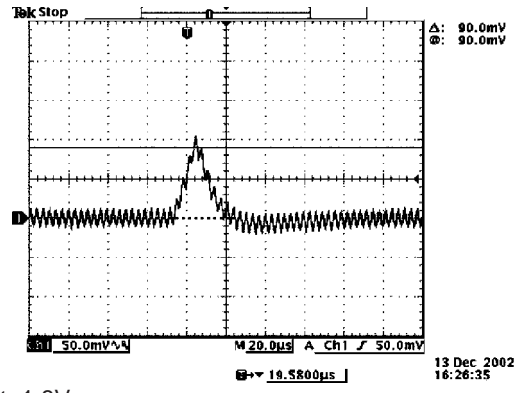

Vout=1.8V
100% to 50% load transients at 3.3V input and Ta=25° C

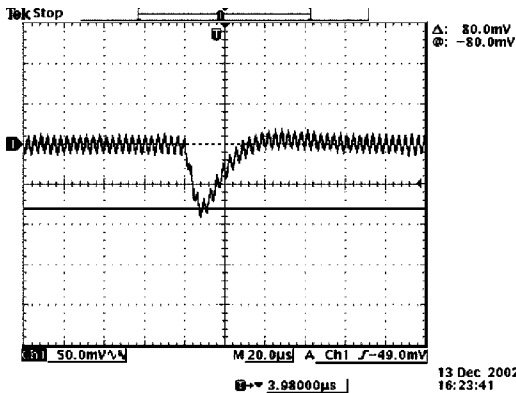

Vout=1.5V
50% to 100% load transients at 3.3V input and Ta=25° C

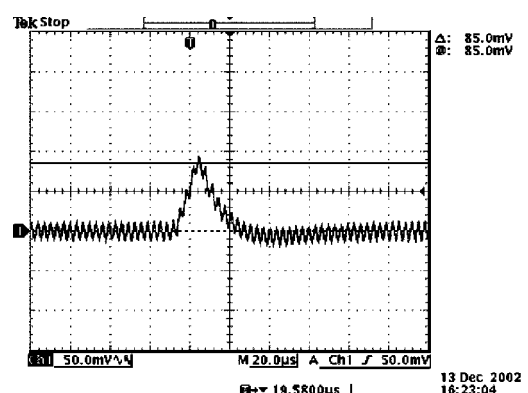

Vout=1.5V
100% to 50% load transients at 3.3V input and Ta=25° C

NON-ISOLATED DC/DC CONVERTERS

3.3V Input / 0.9V – 2.5V Output / 10A



BP03V7PB-10C

Transient Response

Transient response: $di/dt = 0.5A/\mu S$, no external load capacitance

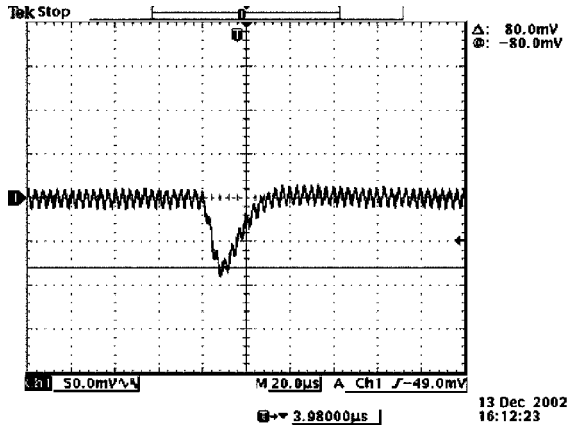

Vout=1.2V
50% to 100% load transients at 3.3V input and Ta=25° C

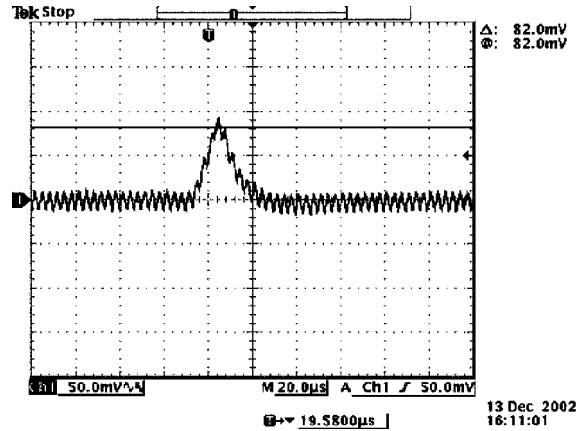

Vout=1.2V
100% to 50% load transients at 3.3V input and Ta=25° C

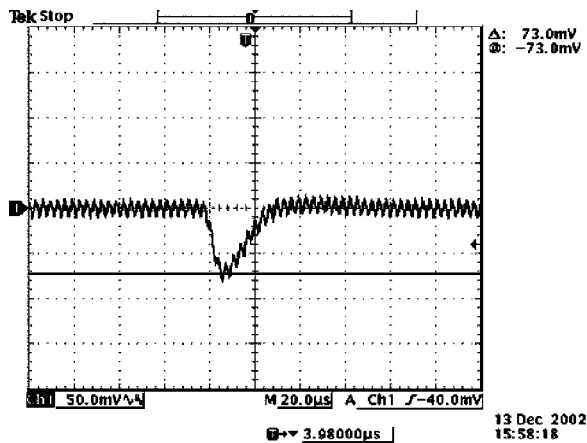

Vout=0.9V
50% to 100% load transients at 3.3V input and Ta=25° C

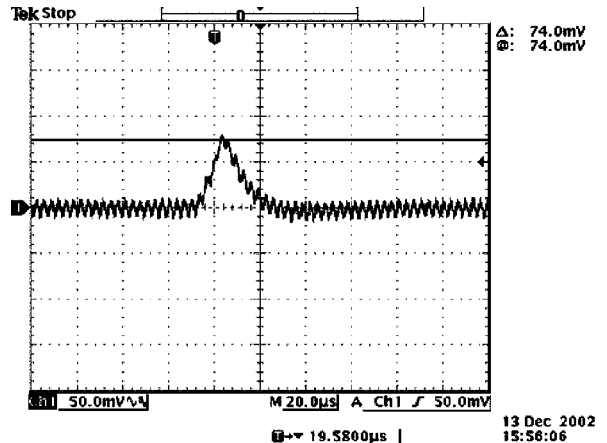

Vout=0.9V
100% to 50% load transients at 3.3V input and Ta=25° C

BP03V7PB-10C

Thermal Considerations

V7PB-10C

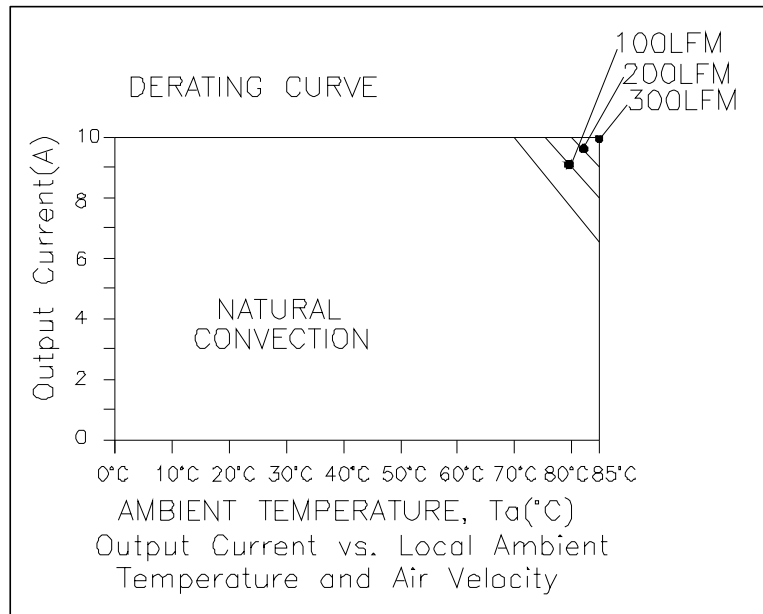

Output Voltage Set-Point Adjustment

Trim Down Circuit

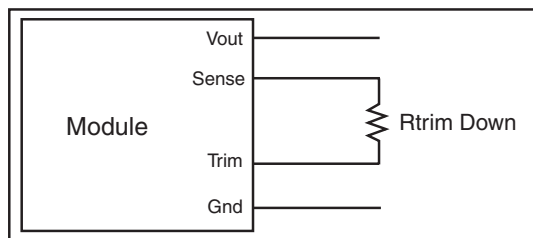

Trim Up Circuit

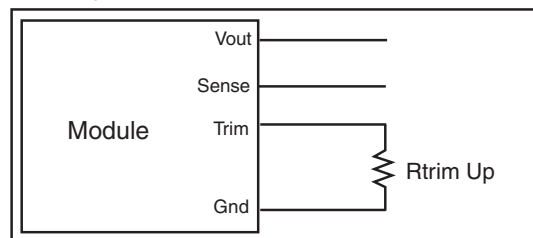

Output Voltage Set-Point Adjustment

V7PB-10C25S Trim Resistor Calculation

$$V_{o_nom} = 2.504 \quad \text{Unit: Volt}$$

$$R_{trim_down}(V_{o_adj}) := \left[\frac{2.15 \cdot (V_{o_adj} - 0.8)}{V_{o_nom} - V_{o_adj}} \right] - 2 \quad \text{Unit: Kohm}$$

$$R_{trim_up}(V_{o_adj}) := \left(\frac{1.72}{V_{o_adj} - V_{o_nom}} \right) - 2 \quad \text{Unit: Kohm}$$

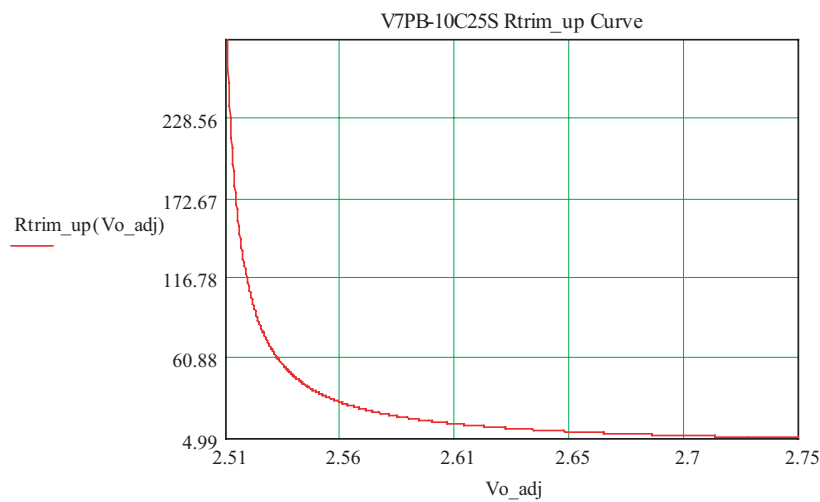
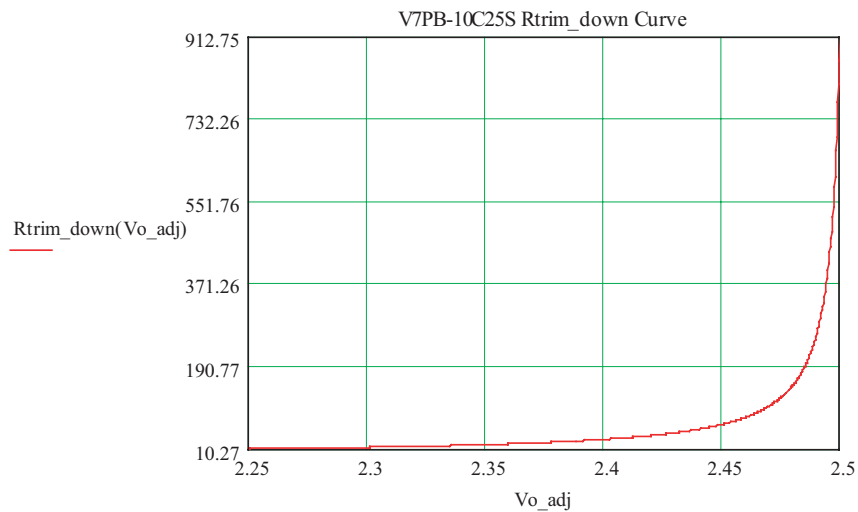

BP03V7PB-10C

Output Voltage Set-Point Adjustment

V7PB-10C18S Trim Resistor Calculation

$V_{o_nom} = 1.804$ Unit: Volt

$$R_{trim_down}(V_{o_adj}) := \left[\frac{2 \cdot (V_{o_adj} - 0.8)}{V_{o_nom} - V_{o_adj}} \right] - 1.78 \quad \text{Unit: Kohm}$$

$$R_{trim_up}(V_{o_adj}) := \left(\frac{1.6}{V_{o_adj} - V_{o_nom}} \right) - 1.78 \quad \text{Unit: Kohm}$$

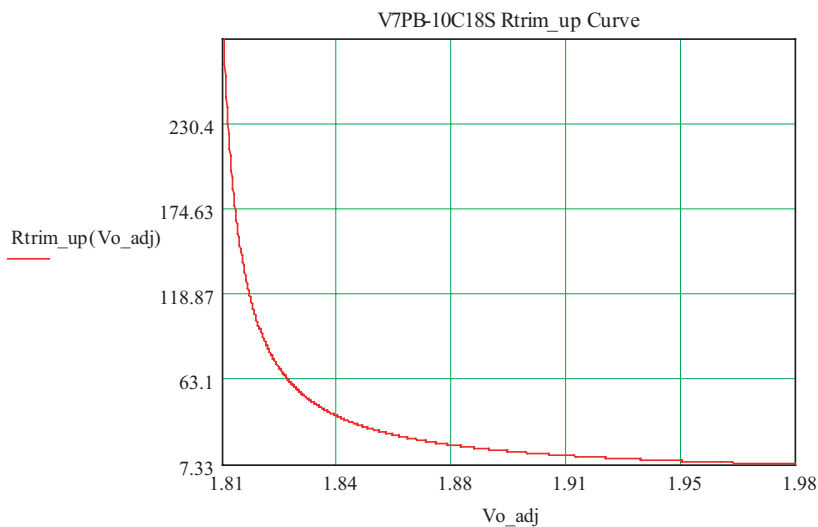
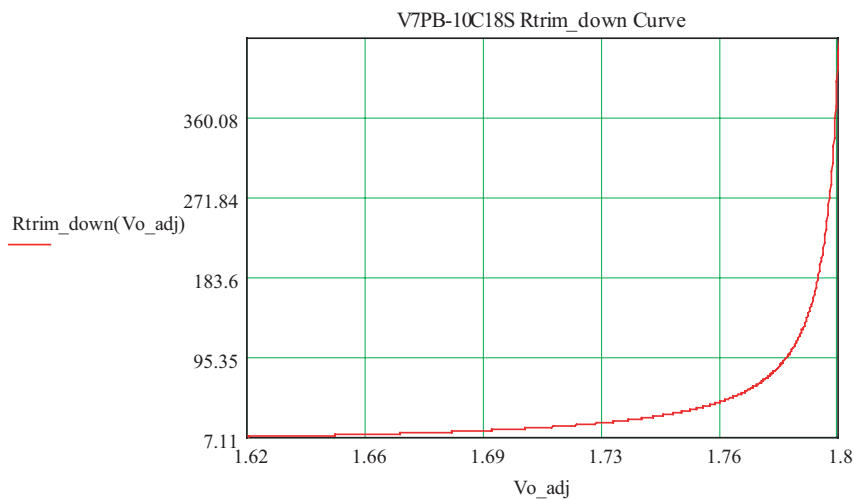

Output Voltage Set-Point Adjustment

V7PB-10C15S Trim Resistor Calculation

$V_{o_nom} = 1.504$ Unit: Volt

$$R_{trim_down}(V_{o_adj}) := \left[\frac{2.15 \cdot (V_{o_adj} - 0.8)}{V_{o_nom} - V_{o_adj}} \right] - 1.78 \quad \text{Unit: Kohm}$$

$$R_{trim_up}(V_{o_adj}) := \left(\frac{1.72}{V_{o_adj} - V_{o_nom}} \right) - 1.78 \quad \text{Unit: Kohm}$$

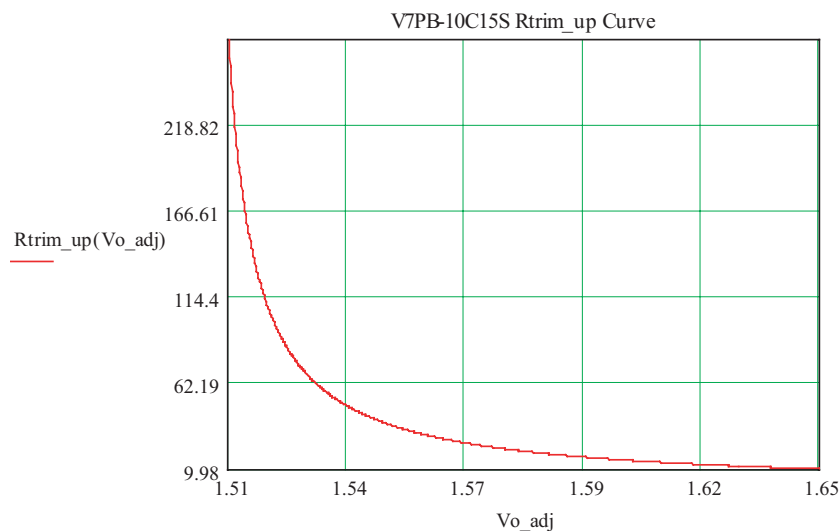
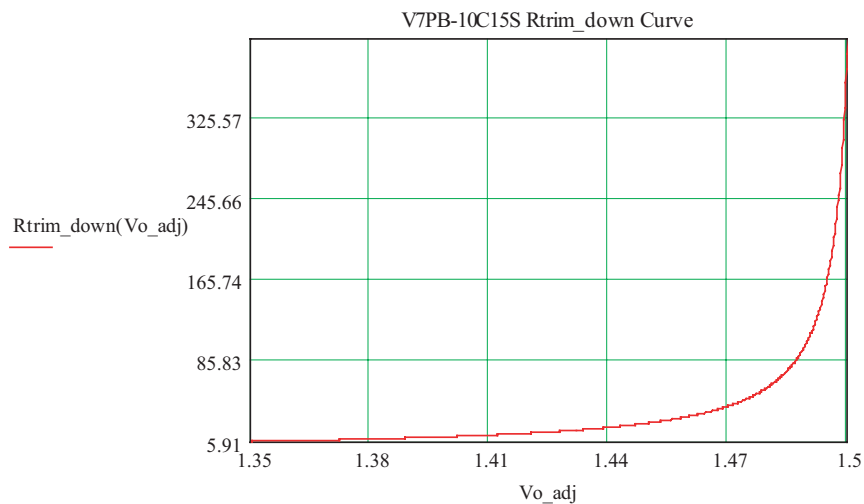

BP03V7PB-10C

Output Voltage Set-Point Adjustment

V7PB-10C12S Trim Resistor Calculation

$V_{o_nom} = 1.204$ Unit: Volt

$$R_{trim_down}(V_{o_adj}) := \left[\frac{2.15 \cdot (V_{o_adj} - 0.8)}{V_{o_nom} - V_{o_adj}} \right] - 0.825 \quad \text{Unit: Kohm}$$

$$R_{trim_up}(V_{o_adj}) := \left(\frac{1.72}{V_{o_adj} - V_{o_nom}} \right) - 0.825 \quad \text{Unit: Kohm}$$

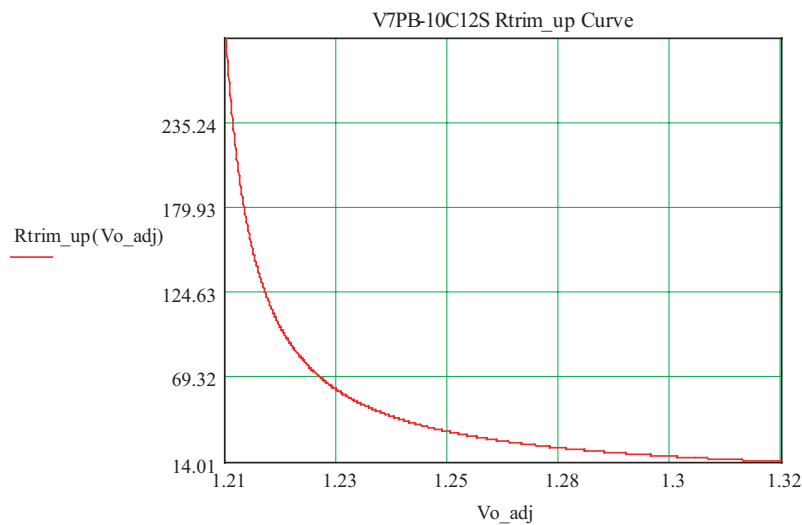
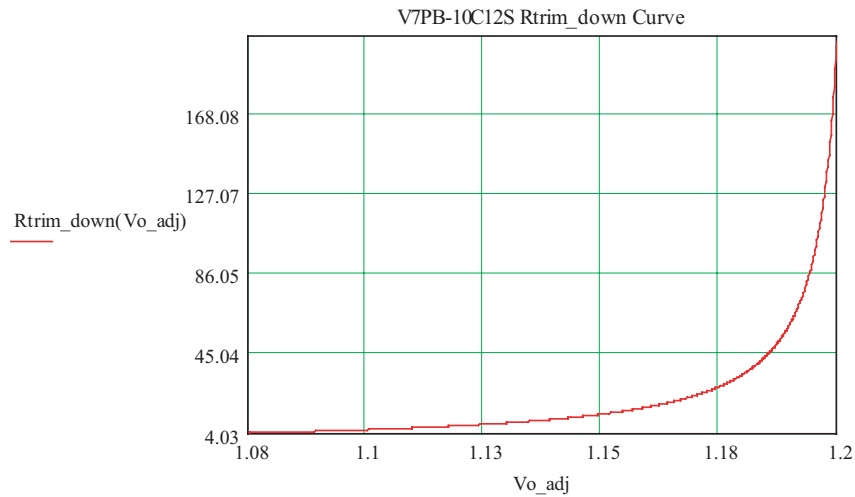

NON-ISOLATED DC/DC CONVERTERS

3.3V Input / 0.9V – 2.5V Output / 10A



BP03V7PB-10C

Output Voltage Set-Point Adjustment

V7PB-10B090 Trim Resistor Calculation

$V_{o_nom} = 0.903$ Unit: Volt

$$R_{trim_down}(V_{o_adj}) := \left[\frac{1.05 \cdot (V_{o_adj} - 0.8)}{V_{o_nom} - V_{o_adj}} \right] - 0.010 \quad \text{Unit: Kohm}$$

$$R_{trim_up}(V_{o_adj}) := \left(\frac{0.84}{V_{o_adj} - V_{o_nom}} \right) - 0.010 \quad \text{Unit: Kohm}$$

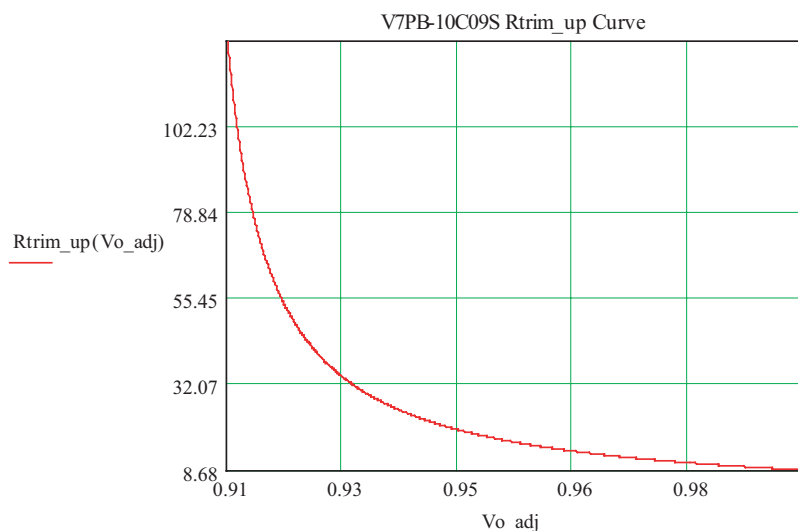
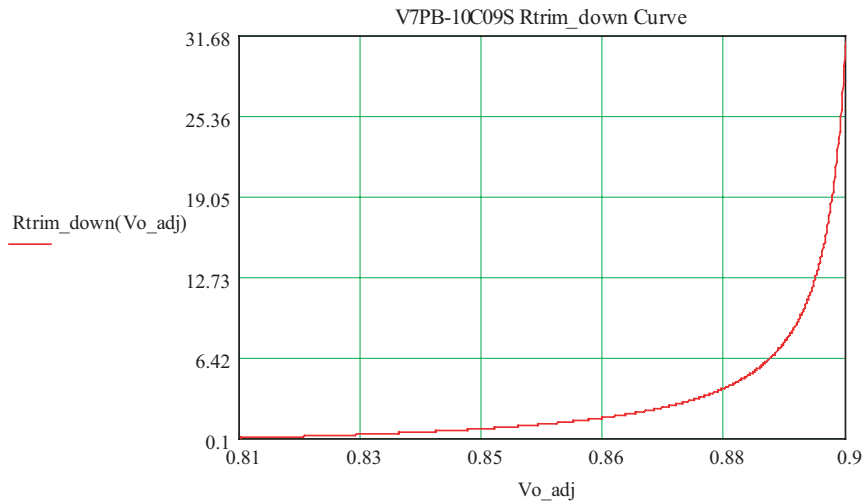

BP03V7PB-10C

Mechanical

V7PB-10C

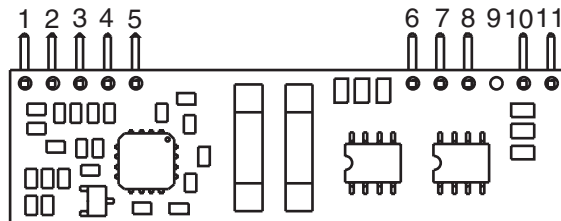
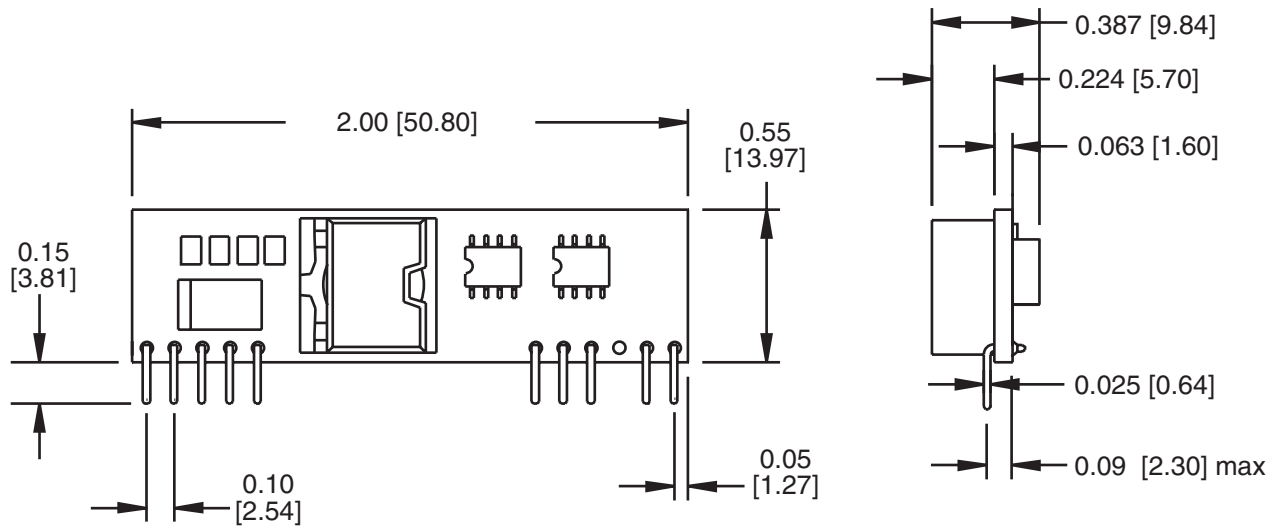

Pin	Function
1	+Vo
2	+Vo
3	Remote Sense Option
4	+Vo
5	Ground
6	Ground
7	+Vin
8	+Vin
9	No Pin
10	Trim
11	Remote On/Off

©2003 Bel Fuse Inc. Specifications subject to change without notice. 09.03

CORPORATE

Bel Fuse Inc.
 206 Van Vorst Street
 Jersey City, NJ 07302
 Tel 201-432-0463
 Fax 201-432-9542
 www.belfuse.com

FAR EAST

Bel Fuse Ltd.
 8F / 8 Luk Hop Street
 San Po Kong
 Kowloon, Hong Kong
 Tel 852-2328-5515
 Fax 852-2352-3706
 www.belfuse.com

EUROPE

Bel Fuse Europe Ltd.
 Preston Technology Management Centre
 Marsh Lane, Suite G7, Preston
 Lancashire, PR1 8UD, U.K.
 Tel 44-1772-556601
 Fax 44-1772-888366
 www.belfuse.com