



# SPE0511

## Single-Line ESD Protection Array

### DESCRIPTION

The SPE0511 are designed by TVS device that is to protect sensitive electronics from damage or latch-up due to ESD. They are designed for use in applications where board space is at a premium. SPE0511 will protect single line, and may be used on line where the signal polarities swing above and below ground.

SPE0511 offer desirable characteristics for board level protection including fast response time, low operating and clamping voltage, and no device degradation.

SPE0511 may be used to meet the immunity requirements of IEC 61000-4-2, level 4. The small SOD-523 package makes them ideal for use in portable electronics such as cell phones, PDA's, notebook computers, and digital cameras.

### APPLICATIONS

- ◆ Cellular Handsets and Accessories
- ◆ Cordless Phone
- ◆ PDA
- ◆ Notebooks and Handhelds
- ◆ Portable Instrumentation
- ◆ Digital Cameras
- ◆ MP3 Player

### FEATURES

- ◆ Transient protection for data lines to IEC 61000-4-2 (ESD)  $\pm 15\text{kV}$  (air),  $\pm 8\text{kV}$  (contact)  
IEC 61000-4-4 (EFT) 40A (5/50ns)
- ◆ Protects single I/O lines
- ◆ Working voltage: 5V
- ◆ Low leakage current
- ◆ Low operating and clamping voltages

### PIN CONFIGURATION ( SOD-523 )



### PART MARKING

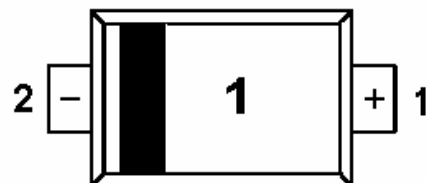



# SPE0511

## Single-Line ESD Protection Array

### ORDERING INFORMATION

Part Number	Package	Part Marking
SPE0511D52RG	SOD-523	1

※ SPE0511D52RG : Tape Reel ; Pb – Free

### ABSOLUTE MAXIMUM RATINGS

(TA=25°C Unless otherwise noted)

Parameter	Symbol	Typical	Unit
Peak Pulse Power ( tp = 8/20 μs )	Ppk	250	W
Maximum Peak Pulse Current ( tp = 8/20 μs )	Ipp	7	A
ESD per ICE 61000 – 4 – 2 (Air )	Vpp	±15	KV
ESD per ICE 61000 – 4 – 2 (Contact )	Vpp	±8	KV
Operating Junction Temperature	TJ	-55 ~ 150	°C
Storage Temperature Range	TSTG	-55 ~ 150	°C
Lead Soldering Temperature	TL	260 ( 10sec )	°C

### ELECTRICAL CHARACTERISTICS

(TA=25°C Unless otherwise noted)

Parameter	Symbol	Conditions	Min.	Typ	Max.	Unit
Reverse Stand – Off Voltage	VRWM				5	V
Reverse Breakdown Voltage	VBR	It = 1mA	6		8.5	V
Reverse Leakage Current	IR	VRWM = 5V , T=25°C		0.01	1	μA
Reverse Leakage Current	IR	VRWM = 3V , T=25°C		0.01	0.5	μA
Clamping Voltage	VC	Ipp = 1A , tp = 8/20 μs			11.5	V
Clamping Voltage	VC	Ipp = 7A , tp = 8/20 μs			15	V
Junction Capacitance	Cj	Between I/O Pin and GND VR = 0V , f = 1MHz		10	20	pF



# SPE0511 Single-Line ESD Protection Array

## TYPICAL CHARACTERISTICS

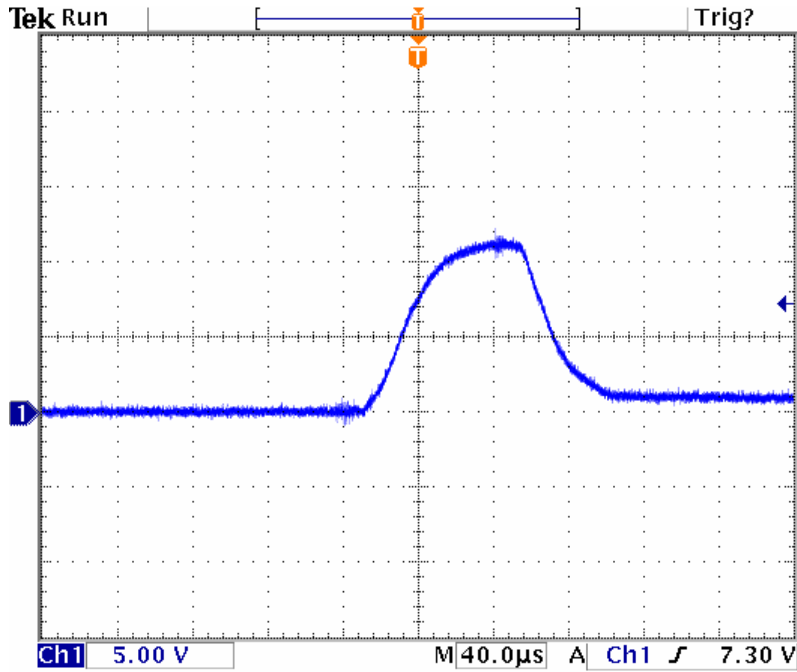

40.0000ns

Clamping Voltage ( $I_{pp} = 1A$ ,  $t_p = 8/20 \mu s$ )

26 Oct 2005  
12:15:46

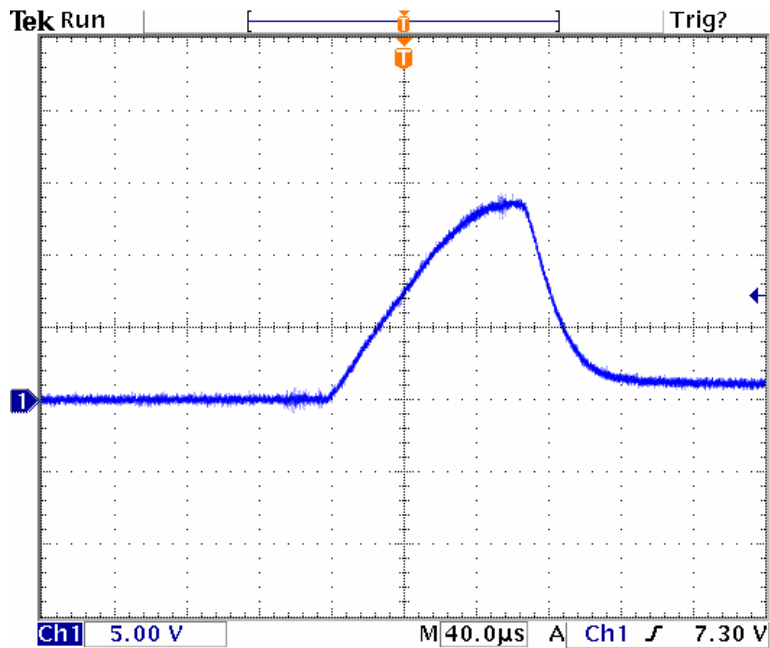

40.0000ns

Clamping Voltage ( $I_{pp} = 7A$ ,  $t_p = 8/20 \mu s$ )

26 Oct 2005  
12:08:20



# SPE0511 Single-Line ESD Protection Array

## TYPICAL CHARACTERISTICS

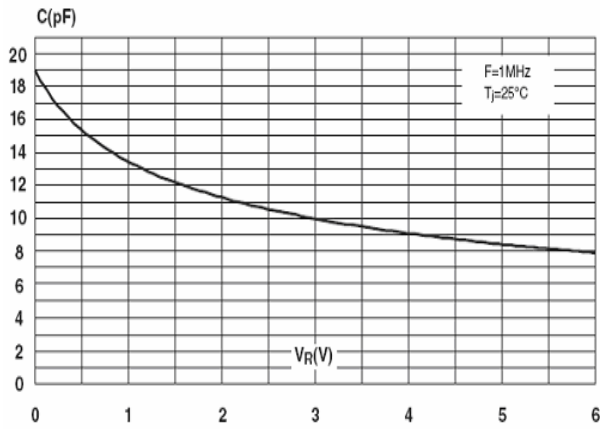

Fig 1 : Junction Capacitance V.S Reverse Voltage Applied

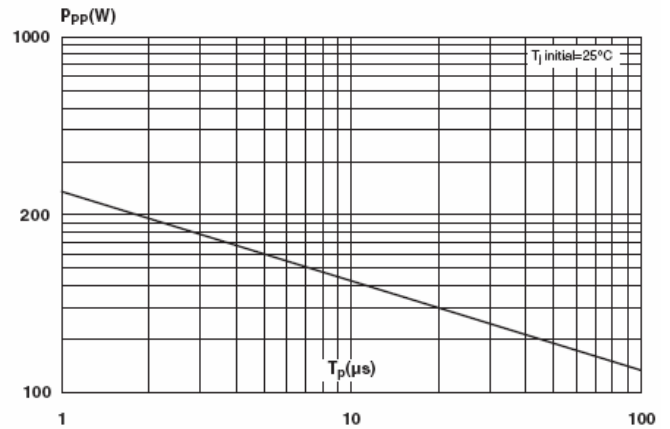

Fig 2 : Peak Plus Power V.S Exponential Plus Duration

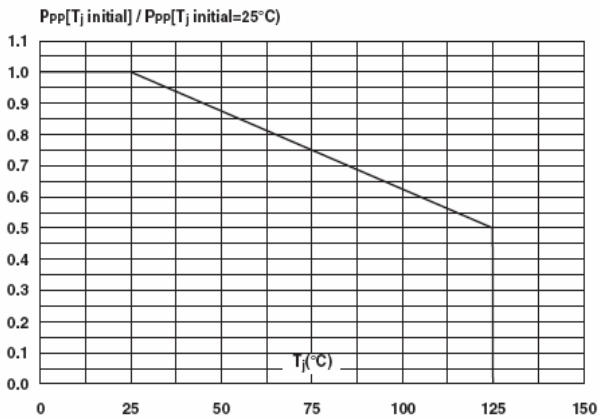

Fig 3 : Relative Variation of Peak Plus Power V.S Initial Junction Temperature

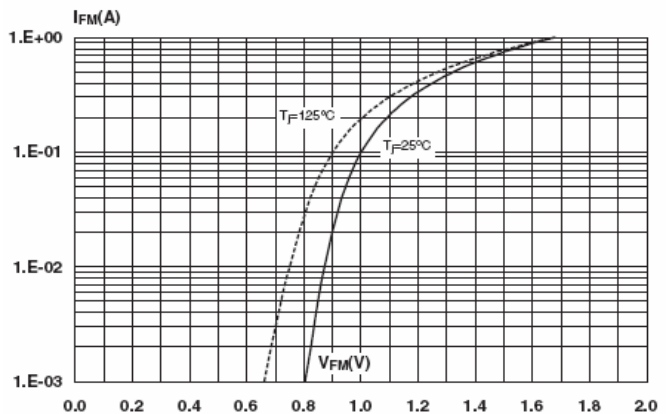

Fig 4 : Forward Voltage Drop V.S Peak Forward Current



# SPE0511

## Single-Line ESD Protection Array

### SOD-523 PACKAGE OUTLINE

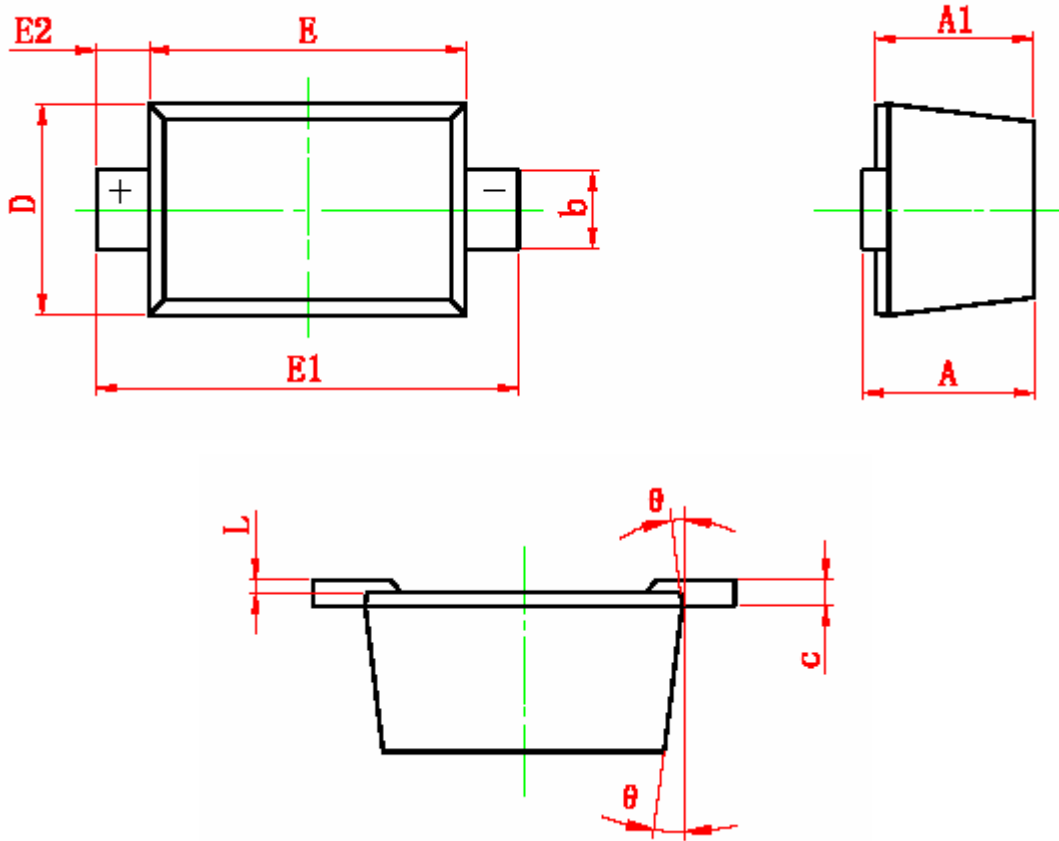

Symbol	Dimensions In Millimeters		Dimensions In Inches	
	Min	Max	Min	Max
A	0.510	0.770	0.020	0.031
A1	0.500	0.700	0.020	0.028
b	0.250	0.350	0.010	0.014
c	0.080	0.150	0.003	0.006
D	0.750	0.850	0.030	0.033
E	1.100	1.300	0.043	0.051
E1	1.500	1.700	0.059	0.067
E2	0.200 REF		0.008 REF	
L	0.010	0.070	0.001	0.003
$\theta$	7° REF		7° REF	



# SPE0511

## Single-Line ESD Protection Array

---

Information provided is alleged to be exact and consistent. SYNC Power Corporation presumes no responsibility for the penalties of use of such information or for any violation of patents or other rights of third parties which may result from its use. No license is granted by allegation or otherwise under any patent or patent rights of SYNC Power Corporation. Conditions mentioned in this publication are subject to change without notice. This publication surpasses and replaces all information previously supplied. SYNC Power Corporation products are not authorized for use as critical components in life support devices or systems without express written approval of SYNC Power Corporation.

©The SYNC Power logo is a registered trademark of SYNC Power Corporation

©2004 SYNC Power Corporation – Printed in Taiwan – All Rights Reserved

SYNC Power Corporation

9F-5, No.3-2, Park Street

NanKang District (NKSP), Taipei, Taiwan, 115, R.O.C

Phone: 886-2-2655-8178

Fax: 886-2-2655-8468

©<http://www.syncpower.com>