

# SF81 THRU SF88

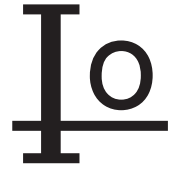

## 8.0 AMP SUPER FAST RECTIFIERS



### FEATURES

- \* Low forward voltage drop
- \* High current capability
- \* High reliability
- \* High surge current capability
- \* Good for switching mode application

### MECHANICAL DATA

- \* Case: Molded plastic
- \* Epoxy: UL 94V-0 rate flame retardant
- \* Lead: Lead solderable per MIL-STD-202, method 208 guaranteed
- \* Polarity: As Marked
- \* Mounting position: Any
- \* Weight: 2.24 grams

### VOLTAGE RANGE

50 to 600 Volts

### CURRENT

8.0 Amperes

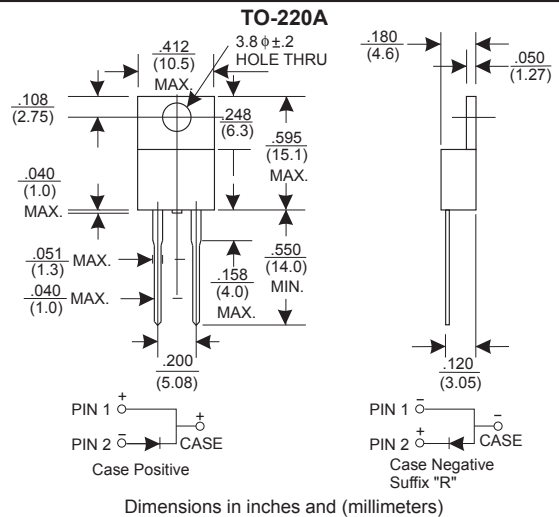

## MAXIMUM RATINGS AND ELECTRICAL CHARACTERISTICS

Rating 25°C ambient temperature unless otherwise specified.  
Single phase half wave, 60Hz, resistive or inductive load.  
For capacitive load, derate current by 20%.

TYPE NUMBER	SF81	SF82	SF83	SF84	SF85	SF86	SF88	UNITS
Maximum Recurrent Peak Reverse Voltage	50	100	150	200	300	400	600	V
Maximum RMS Voltage	35	70	105	140	210	280	420	V
Maximum DC Blocking Voltage	50	100	150	200	300	400	600	V
Maximum Average Forward Rectified Current .375"(9.5mm) Lead Length at Tc=100°C	8.0							A
Peak Forward Surge Current, 8.3 ms single half sine-wave superimposed on rated load (JEDEC method)	125							A
Maximum Instantaneous Forward Voltage at 8.0A	0.95				1.30	1.70		V
Maximum DC Reverse Current at Rated DC Blocking Voltage			10					µA
Maximum Reverse Recovery Time (Note 1)	35				50			nS
Typical Junction Capacitance (Note 2)	50							pF
Operating and Storage Temperature Range T <sub>J</sub> , T <sub>STG</sub>	-65 — +150							°C

#### NOTES:

- Reverse Recovery Time test condition: IF=0.5A, IR=1.0A, IRR=0.25A
- Measured at 1MHz and applied reverse voltage of 4.0V D.C.

## RATING AND CHARACTERISTIC CURVES (SF81 THRU SF88)

FIG.1- TEST CIRCUIT DIAGRAM AND REVERSE RECOVERY TIME CHARACTERISTIC

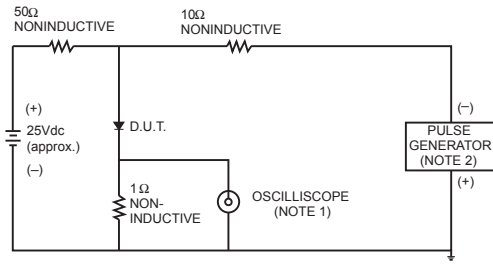

NOTES: 1. Rise Time= 7ns max., Input Impedance= 1 megohm, 22pF.  
2. Rise Time= 10ns max., Source Impedance= 50 ohms.

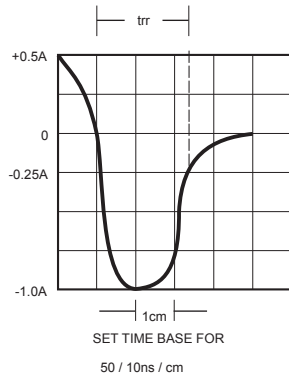

FIG.2-TYPICAL FORWARD CURRENT DERATING CURVE

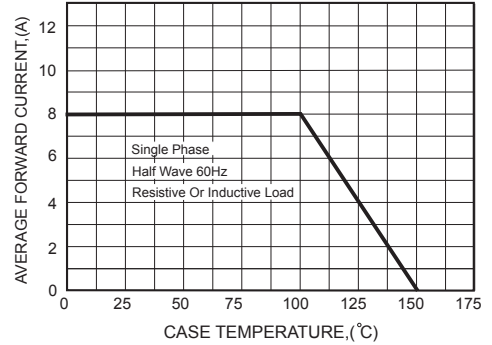

FIG.3-TYPICAL FORWARD CHARACTERISTICS

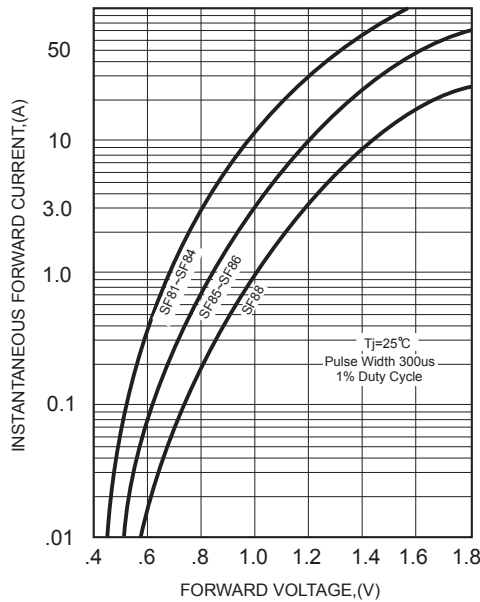

FIG.4-TYPICAL REVERSE CHARACTERISTICS

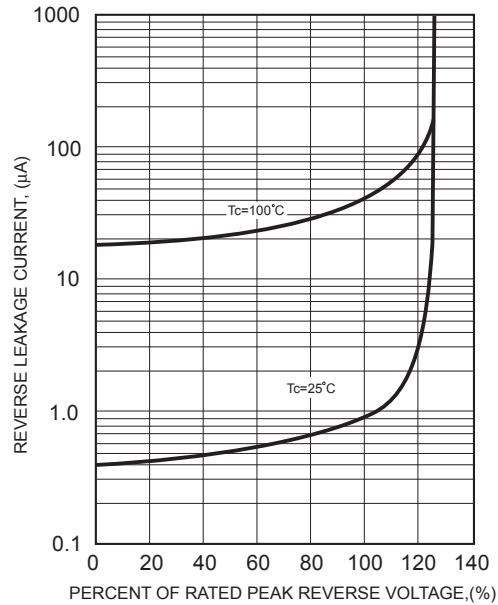

FIG.5-MAXIMUM NON-REPETITIVE FORWARD SURGE CURRENT

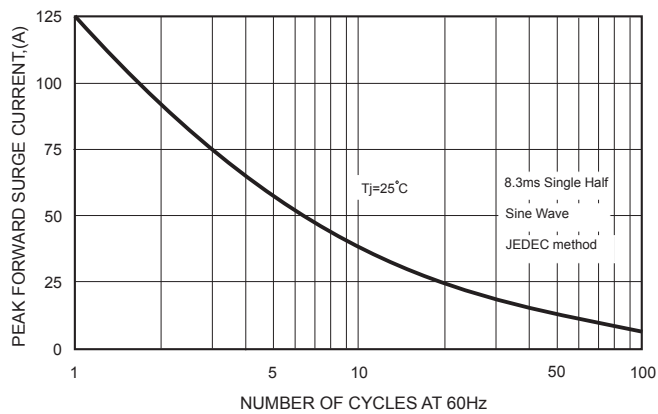

FIG.6-TYPICAL JUNCTION CAPACITANCE

